

LS 990 – The Classic Switch



Since 1968

What is a classic?

A true classic, it is said, is a product from another era that effortlessly survives any trend. A classic is design in perfection. It adapts to new circumstances and challenge easily and with just minimal changes. A true classic sets standards. It is universal, timeless, and even today, unsurpassed.

Reichstag, Berlin
Architect: Foster + Partners, London
Fitted with JUNG LS 990 in light grey.



12
In conversation with: Harald Jung and Herbert W. Richter



34
A classic demonstrates diversity



60
A switch conquers architecture

CONTENTS

The LS 990 switch	04
A classic is born	08
In conversation with: Harald Jung and Herbert W. Richter	12
The switch, the socket	16
A classic is advanced	24
A classic demonstrates diversity	34
In conversation with: Till Schneider	48
A classic shows its colours	54
A switch conquers architecture	60
In conversation with: Wolfram Putz	70
The company	76

Timeless since 1968

The LS 990 is the classic among flat switches: Launched back in 1968, 50 years later its timeless elegance is still just as popular. With the aesthetics of the reduced form, the great user-friendliness thanks to the flat surfaces, and a clear structure, it is still winning over architects and developers today.



Minimalistic and austere, organic and playful, or sensually opulent: With its reduced design and classic shape, the LS 990 suits any architectural concept. Different versions in plastic or genuine metal, not to mention various colours, make for far-reaching possibilities.

Urban villa, Duisburg

Architect: Drusche und Grosser Architekten BDA, Duisburg
Fitted with JUNG LS 990 in Les Couleurs® Le Corbusier,
32140 ombre naturelle 31.



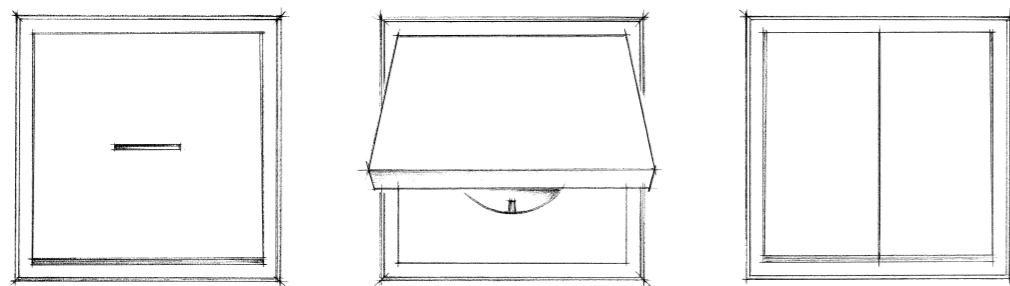
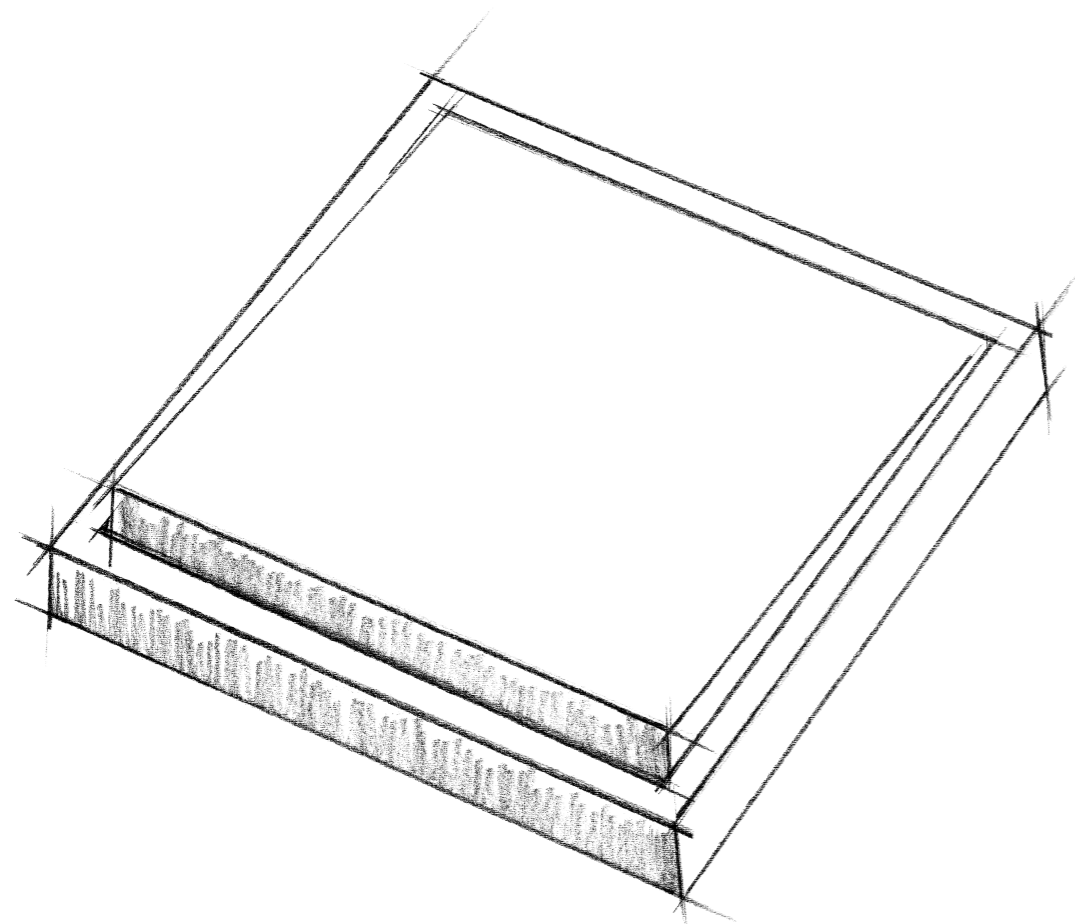

A classic is born

In order to understand the revolutionary design concept the range is based on, one must bear in mind just what light switches usually looked like back then: The actual rocker switch was scarcely wider than a finger and the large panel surrounding it was primarily for protecting the wall or wallpaper from the user's hand. But JUNG wanted a flat switch, and Herbert W. Richter came up with the ideal solution.

Inspired by the Bauhaus philosophy, which calls for a plain design based on practical value and champions clear, elementary forms, he pared down the design to the bare essentials, while at the same time taking up a basic geometric shape: the classic square. "In principle the shape came about on its own," the designer says of it modestly.

"I asked the technicians about the maximum size the surfaces could be, and the largest

possible dimensions of 71 x 71 millimetres on the inside and a cover measuring 81 x 81 millimetres gave rise to the basic design: a 70 x 70-millimeter switch with a 5-millimeter surround."

The new range not only met all the demands of cutting-edge interior design; it also became the basis for advancing light switches. Today, 50 years later, the LS 990 is still gaining in popularity with architects and interior designers, is the JUNG range with the strongest sales, and is now available in several versions and various materials.

Unchanged in terms of shape, it is just as timeless as it is adaptable, and fits in with any architectural concept. Whether, at the time, the managing directors and designers had any inkling of how contemporary the range would be 50 years down the road is another matter.

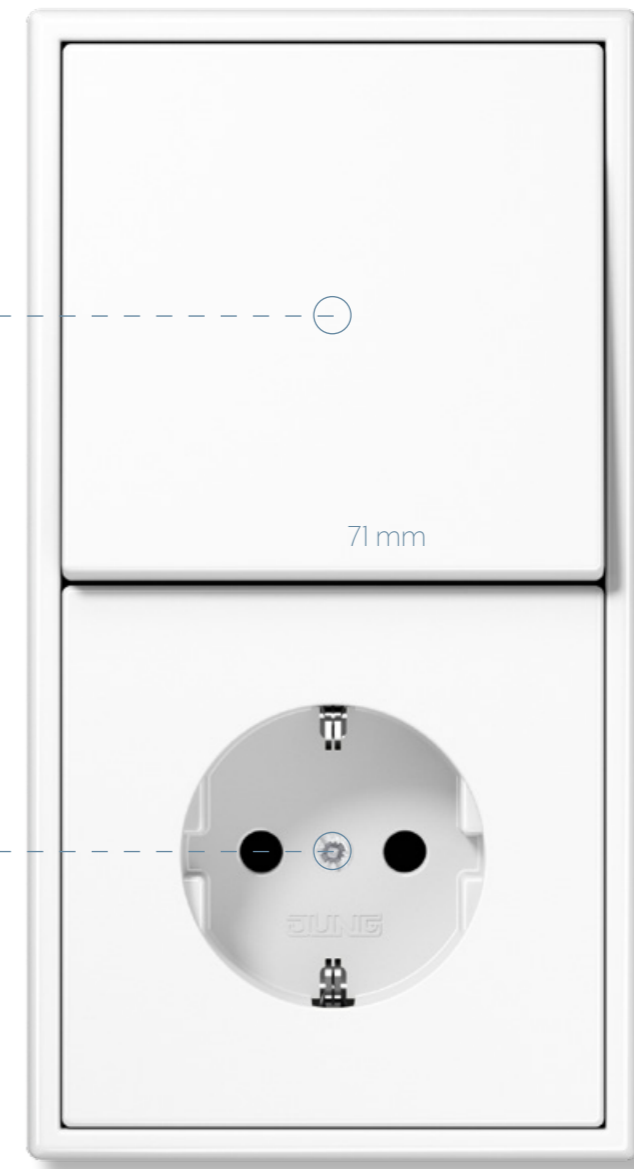
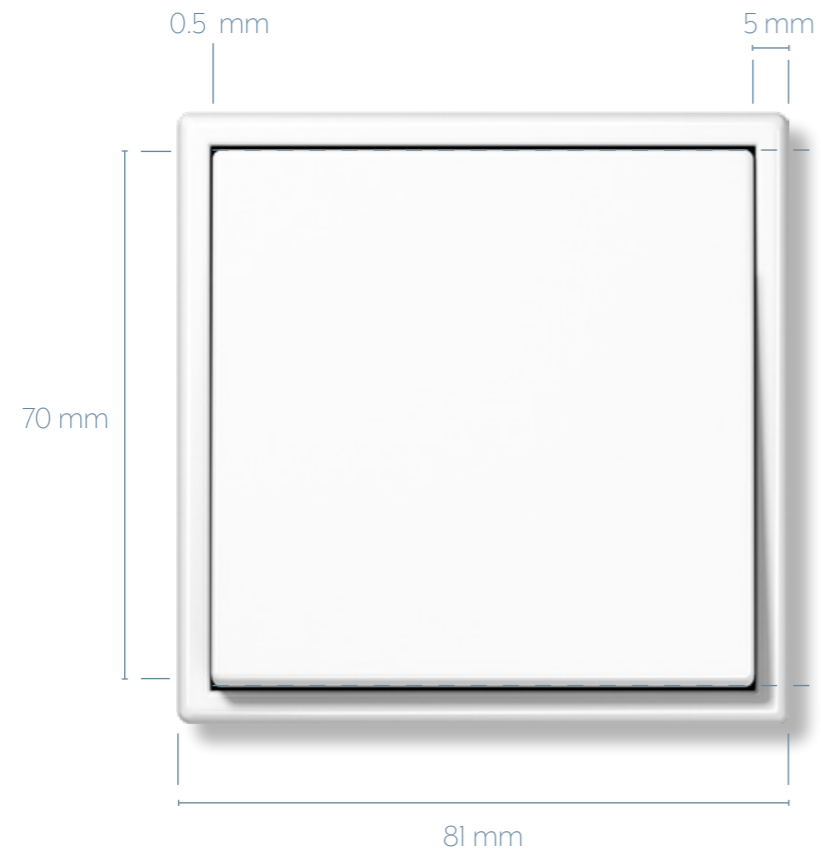

LS 990 is based on the classic square and exploits the possible switch area to the full. The maximum of 71 millimetres on the inside with a cover measuring 81 millimetres results in a 70 x 70-millimetre switch with a 5-millimetre surround.

In conversation with: entrepreneur Harald Jung and designer Herbert W. Richter

Mr. Richter, you are a trained graphic artist. At the time, how did you approach the task of designing a light switch, and how did you arrive at its shape?

Herbert W. Richter: In principle the basic shape almost came about on its own: JUNG wanted a switch with a large surface area, so I asked the technicians how big the surfaces could be. The largest-possible inside measurements (for technical reasons) of 71 x 71 millimetres and the 81 x 81-millimeter cover gave rise to the design possibilities: a control surface measuring 70 x 70 millimetres, with a 5-millimetre surround.

The switch looks very graphic. Could one say that it looks like that because it was designed by a graphic artist?

Herbert W. Richter: Yes, of course, but in itself there's nothing negative about that. In hindsight there's even something very positive about it.

Did you have any idea at time of the impact your design was going to make?

Herbert W. Richter: No, not in the least. That is also evident from the catalogue at the time. We advertised the LS 990 on a single page, as we wanted to tread carefully and see whether customers took to the range at all. So there was absolutely no hoo-ha, along the lines of: We have a new product line! As such, for a long time the system was just one of many JUNG systems. It is only in the past 25 years that it has developed in a disproportionate way.

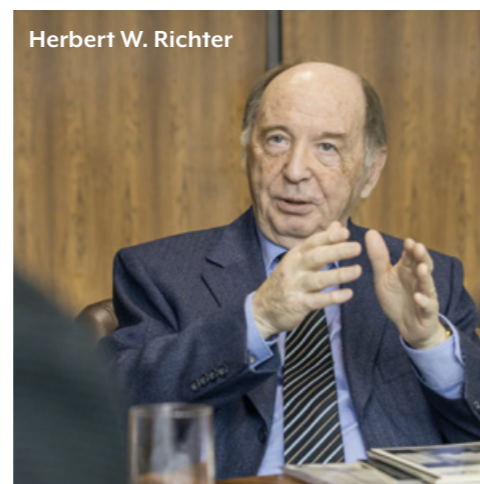

Herbert W. Richter

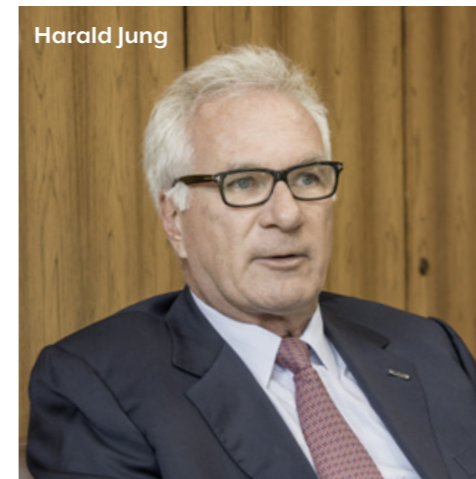

Harald Jung

Nowadays the range is very popular with architects. Did you have this specific target group in mind at the time, or did you just want to design the best-possible switch in line with your client's specifications?

Herbert W. Richter: Both. Given that I came from the graphic design scene I was of course interested in a straightforward, plain shape, the sort that also tends to be popular with architects. But that is the same with all product design. In the long term, a clear form and a design that reveals and helps the function is always the best solution.

Harald Jung: That is exactly what my father Siegfried Jung thought.

What significance does the LS 990 have in the company today?

Harald Jung: LS 990 is the range with the strongest sales. Which is why there are the most versions of it. LS simply offers lots of ways of putting something in a frame. That said, the sector has kept on spreading rumours that we are going to halt production of the LS. Simply because we have annoyed our

competitors so much with our success and the constant enhancements such as new materials and new colours.

Herbert W. Richter: But we also have to realize that in the market trends in taste come and go in waves. As such, over the past 50 years the range experienced various highs and lows – and will continue to do so. Right now LS is enjoying greater popularity again, a trend I hope is going to last for some time.

What prompted the use of materials such as aluminium and stainless steel, and the version in black?

Herbert W. Richter: The impetus for the black frames came from the architecture company schneider+schumacher. As did that for the LS range in light grey, for which Norman Foster had expressed a desire for the Reichstag in Berlin. And the aluminium and stainless steel versions also came about at the request of architects for specific buildings.

Harald Jung: Our competitors sometimes also launch innovative products, to which we have to respond. For example with new materials or, indeed, colours. Les Couleurs® Le Corbusier basically came via our marketing department. And I readily admit that at the time I underestimated what a success story it would be with architects and interior designers. We created other new products such as LS Zero on our own. We have recognized that there is a trend towards flush-mount interior design and have decided to respond accordingly, with the range that is destined for it.

And what's coming next?

Harald Jung: Right now it's primarily a case of integrating all manner of electronic applications for building control systems, such as small screens for door intercoms or radios. But we are not going to alter the basic design.

Herbert W. Richter: For a long time now I've wanted a 71x71-mm display for the range, which for a wide range of reasons we don't yet have. Furthermore, there is a whole host of ideas that still have to be put to the feasibility test.

Are you thinking about other materials as well? The switches could also be made of wood, or perhaps even of concrete?

Harald Jung: We have already given thought to all kinds of different materials, ceramic for example, carbon, and to switches and frames made entirely of glass. To date we haven't been able to make them for economic reasons. Made of carbon, a single switch would cost almost 400 euros, which probably nobody would be prepared to spend, or at least too few to be able to produce it on an industrial scale. We do, however, now have a plant where we can also produce lots of things individually. That gives us enormous product depth. It also sets us apart from Asian competitors and protects us from copycats. In addition to the switch and the socket, the product line also features applications such as a door intercom, a telephone, and a TV socket.

Mr. Jung, you just mentioned your foreign competitors. Have you yourself ever considered producing at sites other than Schalksmühle and Lünen, even abroad?

Harald Jung: Perhaps 25 or 30 years ago we once considered moving to Baden-Württemberg in southwest Germany with part of the company or at least a production plant, as it is a region with strong sales. But my father and the then co-managing director Mr. Schulte



very quickly realized that our highly motivated and experienced workforce is based here in Schalksmühle and Lünen. At the end of the day anyone can build a new production building somewhere and sell machines, but replacing an established employee structure is not quite as easy. What's more, we naturally felt we had a duty to our employees. For us, people are more important than switches,

and that is why we actually generate most of our value added here in the region, and over 90 percent of our manufacturing is done in Germany. And that is certified by the TÜV, the German business that provides inspection and product certification services. So we are not like other companies, which pretend to manufacture in Germany but outsource part of their production to Poland, the Czech Republic, or even China.

But sometimes you too will feel pressurized to go to Asia to reduce your production costs.

Harald Jung: That might well work in the short term, but definitely not in the long term. At the end of the day we have automated so much that it will scarcely be possible to produce mass goods more cheaply. Our nearest supplier is in the immediate vicinity. They produce bases for sockets. And most of the other suppliers are within a radius of 40 to 50 kilometers from Schalksmühle.

To finish, I'd be interested in what tomorrow's switch is going to look like. Do you have a vision?

Herbert W. Richter: To a minor extent, classic switches will adapt to the current trend in taste, but will otherwise hardly change at all. Parallel to this there will be advances in electronics, but making concrete predictions would be like



reading tea leaves. I am basically convinced that the mechanical switch is still going to be around in 20 or 30 years, even though it has already been frequently written off, by young people fascinated by electronics.

Harald Jung: I too am convinced that the classic, mechanical switch is going to survive. But the future also belongs to smart households. And with our KNX solutions we are well prepared.

The interview was conducted by Christian Schittich, architect and specialist author.

Every year 14 million sockets and 8 million flush-mounting units for switches, produced on fully automated production lines, leave the JUNG production in Schalksmühle and Lünen. This is achieved using high-performance punching presses with a capacity of 700 supporting rings per minute. Over 1,000 varieties are produced on flexible assembly lines, in line with client specifications, and also in smaller numbers. This way JUNG is able to offer a wide range of products and high delivery capacity.

The tools the company developed and produces itself guarantee the highest of precision with regard to the finishing. For generations the parts manufactured by suppliers have for the most part been coming from the region. Great importance is placed on sustainability in the manufacturing process. With a production ratio of over 90% in Germany, JUNG has received "Made in Germany" certification from TÜV Nord.

The switch, the socket





The light switch is the visible element that forms a link between the electrical installation and the relevant space. As such, it has to satisfy both aesthetic and functional standards. The obvious quality of the surface conceals the many mechanical parts inside the switch. The valid standard requires 40,000 acts of switching during testing. JUNG itself demands that its switches be activated 50,000 times. Only then are JUNG switches marketed.



The JUNG SCHUKO® socket enables non-stationary consumers to be operated. Clearly visible, it withstands the mechanical load and delivers the requisite voltage. The actual quality, however, is concealed in the contacts and base, and as such in the wall. Eighty tons of high-performance punching presses shape the metal parts, which are then assembled in complex modules. During production the socket is fully checked for abnormalities on several occasions. JUNG likewise tests its sockets 25,000 times, which is 2.5 times more than the German standard requires.



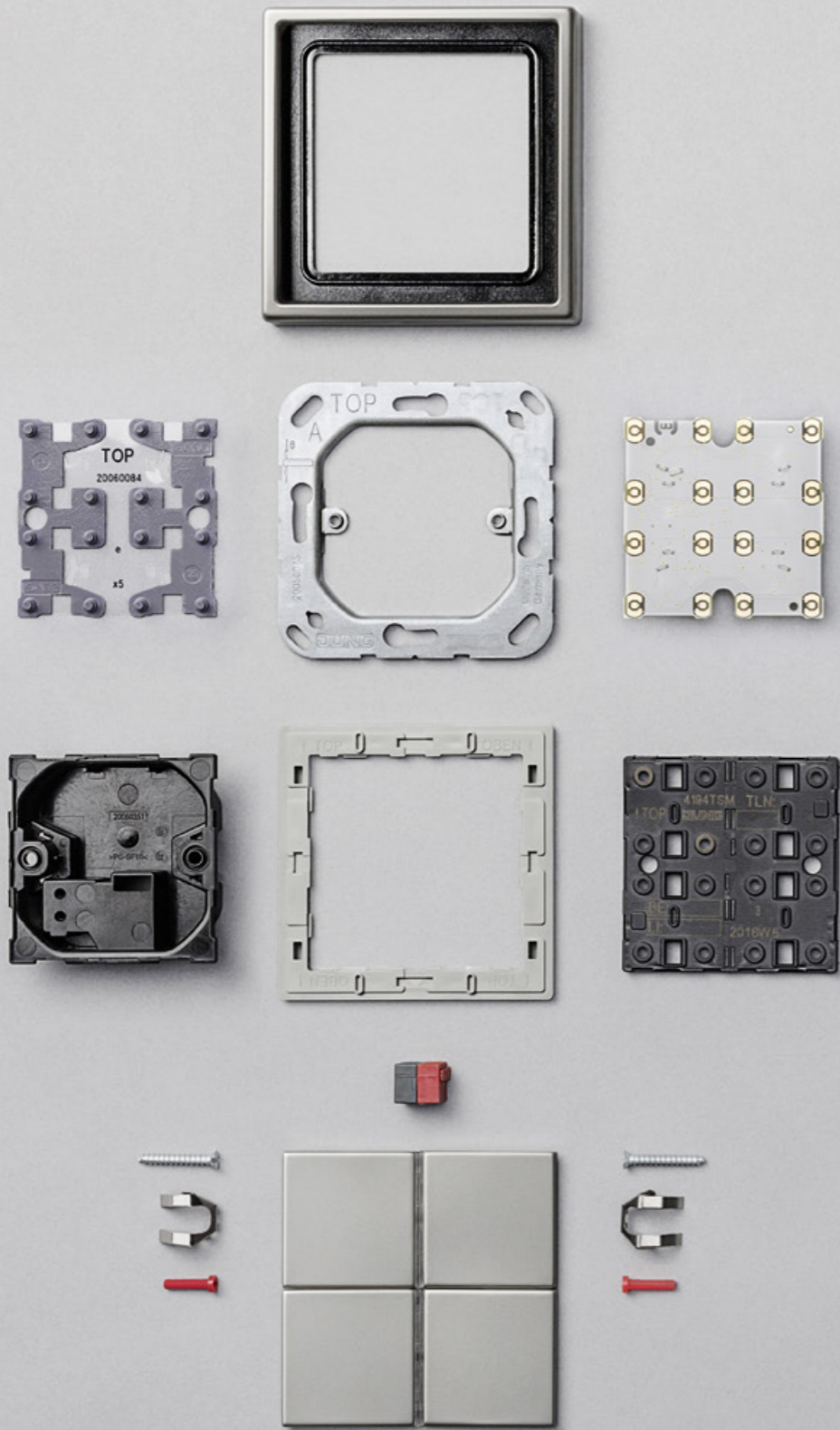

The F 40 push-button sensor serves control functions in KNX systems. It boasts a spacious flat surface, and with the compact form of its electronics enables up to eight functions to be operated with a single push-button. As such, the regulation of temperature, light, and shutters can be integrated in the electrical installation without trace. Here too, JUNG succeeded in realizing the metal versions with genuine materials. In line with works guidelines, the 40,000 successful changes of setting during testing required by standard EN60669-1 are exceeded by at least 25%.

A classic
is advanced



LS 990 in white



LS 990 in brown, grained leather



LS 990 in marble-white



LS 990 in black



LS 990 in stainless steel



LS 990 in light grey



LS 990 in aluminium



LS 990 in anthracite

1968

LS 990 is launched as a flat switch. The Duroplast version in white underscores its outstandingly clear form.



1979

In line with contemporary tastes, the switch has been available in various brown tones, including a grained leather version, for several years now.



1984

Likewise in keeping with the decade, the version with a marble look.



1998

The switch in black was launched for the Cubus Hotel in Düsseldorf, and is still popular with architects today.

Architects:
schneider+schumacher Architekten,
Frankfurt/Main



1999

The stainless steel version was the first JUNG switch in the LS range in genuine metal. Another design for a specific construction project, the Office of the Federal President in Berlin.

Architects:
Gruber + Kleine-Kraneburg, Frankfurt/Main

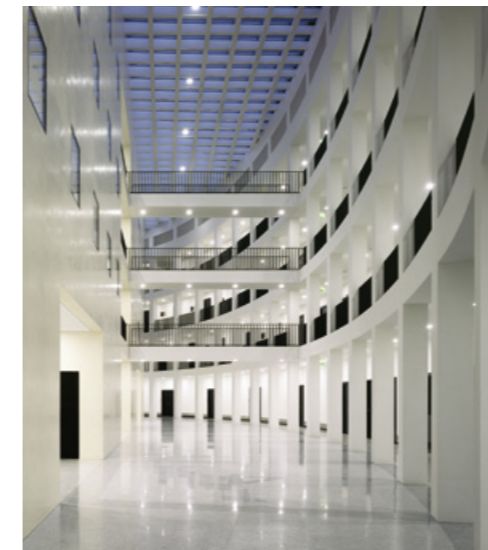

The light grey version followed the same year, for the new Reichstag building in Berlin.

Architects:
Foster + Partners, London



2002

In 2002 JUNG surprised the market with the sector's very first set of switches in aluminium, for the Federal Ministry of Labour and Social Affairs.

Architects:
Prof. Paul Kleihues, Berlin



2006

As a result, the anthracite version complements the portfolio, here in the Tribunal d'Instance et CPH in Montmorcency.

Architects:
Dominique Coulon et associés, Strassbourg





LS 990 in chrome



LS 990 in gold

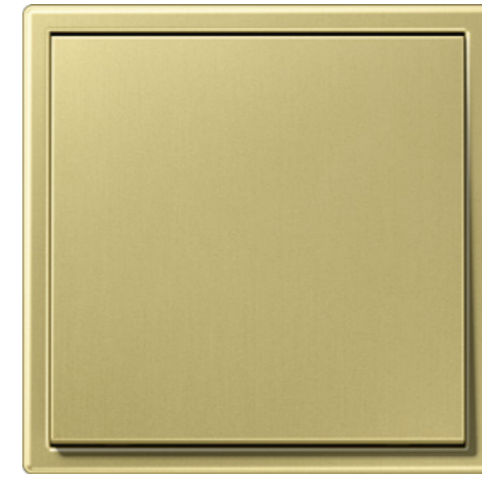

LS 990 in brass



LS 990 in Les Couleurs® Le Corbusier



LS 990 in dark



LS ZERO

2006

In 2006 the chrome version added a touch of elegance. In the Breidenbacher Hof hotel in Düsseldorf they stylishly emphasize the ambiance.

Interior design:
Peter Silling & Associates,
Hotel Interior Design Silling, Cologne

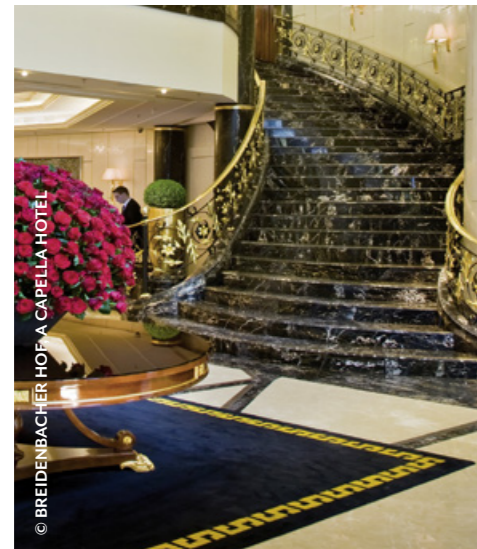

2008

In 2008 the LS 990 in genuine gold was launched. Ever since, the 24-carat gold-plated version has embellished the Ritz Carlton in Moscow.

Interior design:
Peter Silling & Associates,
Hotel Interior Design Silling, Cologne



2012

In 2012 it was a case of a shift from traditional material to elegant switch design. Genuine brass, finished by hand for Lehnbachhaus in Munich.

Architects:
Foster + Partners, London



2014

As a worldwide exclusive, JUNG launched the LS 990 in the 63 Les Couleurs® Le Corbusier colours. In order to achieve the impressive depth of colour, the switches are hand-painted.

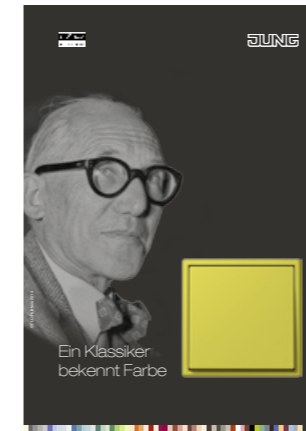

A classic shows its colours: Another Venice in Venice. In a 19th-century residential building, the LS 990 in various Les Couleurs® Le Corbusier colours is an ideal addition to the design concept and underscores the individual mix of historical, traditional, and reduced state-of-the-art components.

Architects:
Marcante-Testa, UdA Architetti



2016

Timeless, reduced, consistent: LS ZERO. The multi-award-winning flush-mounted version, here in Palais Fidelio in Bonn.

Architects:
Oezen-Reimer & Partner, Bonn



Dark matt aluminium gives the straight lines of the classic switch an intensive aura, like here in Hotel Liberty in Offenburg.

Interior design:
Konrad Knoblauch GmbH, Markdorf



A classic demonstrates
diversity

Diversity in a square

From the outset, the LS 990 was designed to evolve. Given its construction principle featuring a large switch, it is geared to exploiting space to the full – meaning innumerable functions can be accommodated. From classic switch and light and temperature regulation to facility management applications. In technical terms, the system has been cutting-edge for 50 years.



Non-stop metal

A focus on metal was particularly close to founder Albrecht Jung's heart. As such, as early as the 1920s the company started concentrating on metal processing. Plastic parts are manufactured by nearby suppliers using tools made by JUNG.

For us, metal is metal

The slender LS 990 frame and the small radii require the greatest of precision in terms of construction and tool making. JUNG has also always manufactured the inserts for the frames using the same material. This requires a separate tool for over 200 various products. The manufacturing procedures are geared exactly to the characteristics of the various metals. In the case of aluminium, the switches are folded; in the case of stainless steel they are deep-drawn and shot-blasted.

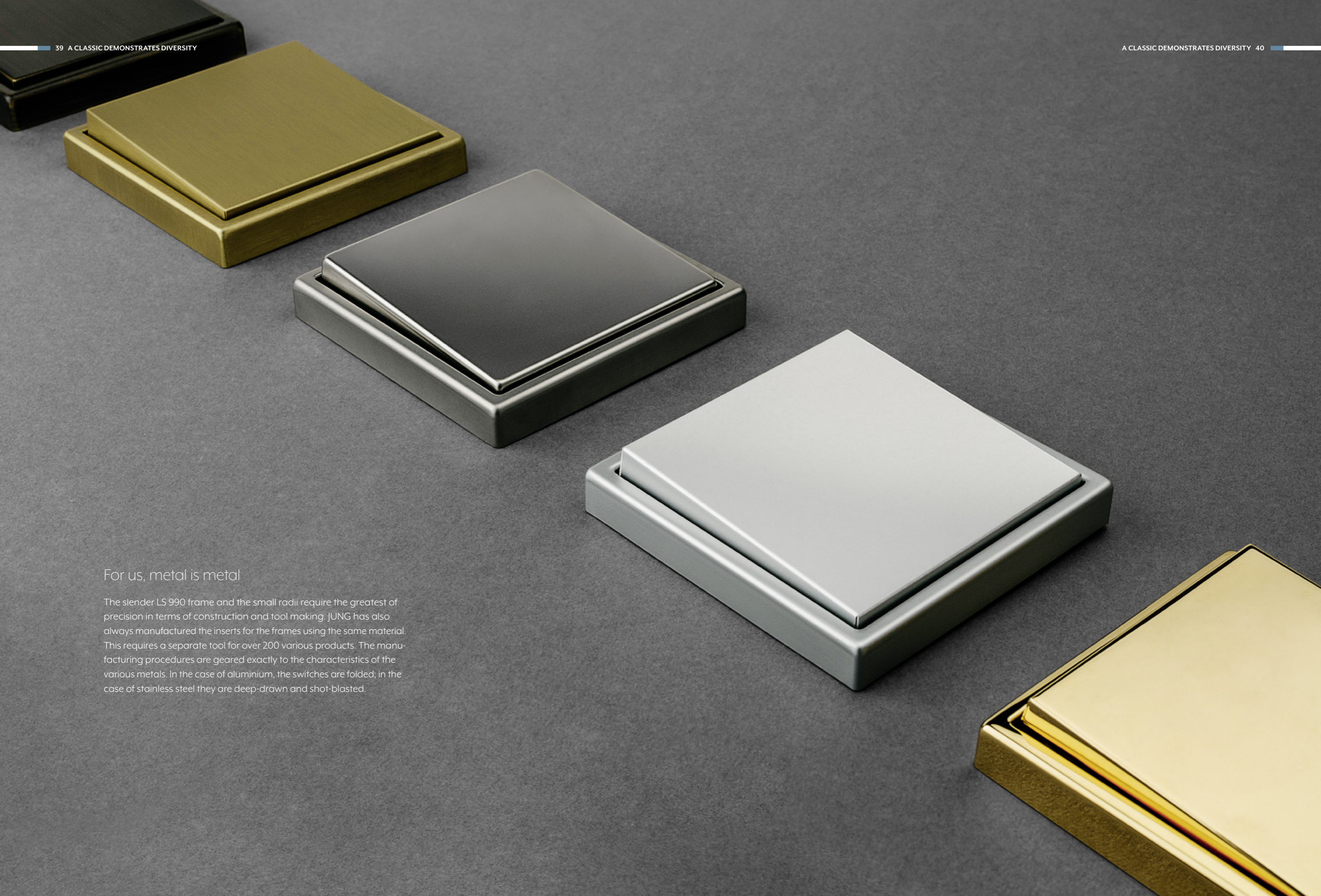

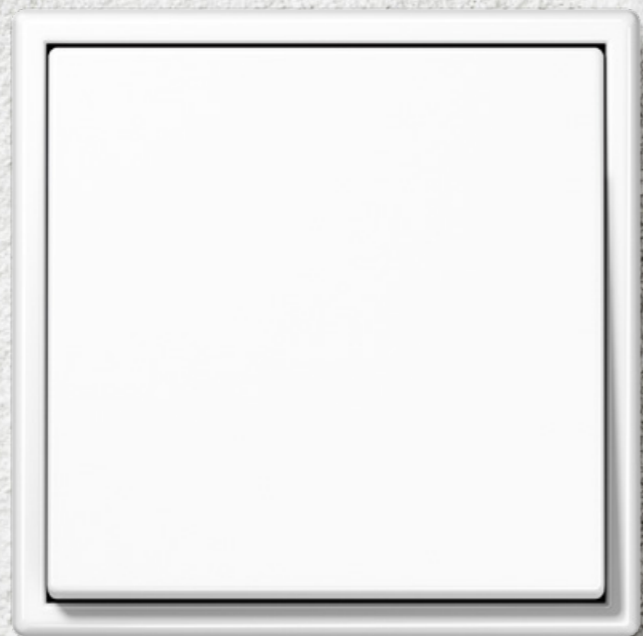

Duroplast: A classic among plastics

Duroplast stands out its high durability, surface hardness, and temperature resistance. It is scratch-resistant, halogen-free and as such particularly suitable for challenging products.

White stays white

The version in high-quality Duroplast in white marked the start of the LS ranges, and even today is the most popular. Later on, colours such as black and light grey were added. Thanks to Duroplast's properties, even regular disinfection has no impact on the material's light resistance; the colours stay the same its entire life.





Joints are a major issue
in architecture.

Through integrated planning with various trades, the design of the flush-mounted version LS ZERO has solved the interface problem. The installation method is coordinated with the work method of those performing the work. The result: flowing, level transitions between the surface and the control element. Regardless of whether the socket is in a plastered wall, a dry wall, or in furniture. JUNG has received several awards for this patented advance.

LS ZERO

In conversation with:
Till Schneider

Cubus Hotel, Düsseldorf

Architect: schneider+schumacher, Frankfurt/Main
Fitted with JUNG LS 990 in black.

IDE

© JÖRG HEMPEL PHOTO DESIGN

EMILY
COFF





In your company schneider+schumacher you repeatedly use the LS 990 switch range by JUNG for all kinds of construction projects – why?

Till Schneider: I myself came across JUNG switches in the architecture studios I worked in when I was a student in the 1980s. At Oswald Matthias Ungers the LS 990 was the only switch they used – then still in white. It was a similar story later on when I was at eisele + fritz. Although the architecture there was entirely different, they used the same light switches and sockets. And I also heard from fellow architects at other studios at the time that the range was pretty popular there too. So it was an obvious choice for me to use the LS 990 in the first projects of my own too.

As of when did you want to have the switches in black?

Till Schneider: In the late 1980s I converted the attic in my father's house in Darmstadt and clad one of the walls in black panels. I wanted switches and sockets in the same colour, but couldn't get them from JUNG. So I went to an auto body paint shop and had the LS 990 components sprayed black. These switches still work today and haven't lost any of their colour. When our studio grew later on, we had a hotel project in Düsseldorf in 1996 and wanted black walls there too. We contacted JUNG again and because this project was a lot bigger than the last, this time they agreed to produce a dark version for us. It was already on the drawing board back then anyway.

“I also heard from fellow architects at other studios at the time that the range was pretty popular there too ...”

And now JUNG even offers painted switches ...

Till Schneider: ... yes, the version in the Le Corbusier colours is a real boon. If you don't want to celebrate the installation, but rather integrate it, it is an obvious choice to use coloured switches. On coloured walls a white switch sometimes just doesn't look right.

Do you have any other wishes as regards the range?

Till Schneider: I hope above all that the process of switching itself doesn't get too complicated, for instance with the use of touchscreens. It is already the case today that you sometimes don't know how to switch the lights off in a hotel room. Despite having a great affinity with technology, there have been times when I too have had to unscrew

the bulb or pull out the plug in such a situation. Before I have to read detailed instructions for use, I would prefer simply being able to flick a regular switch.

So the classic switch will be around for some time to come?

Till Schneider: Yes, in many cases it will remain the best solution in the future too.

The interview was conducted by Christian Schittich, architect and specialist author.



With its reduced and timeless form,
the LS 990 blends playfully into any
architectural concept.

Städel Museum, Frankfurt/Main

Architect: schneider+schumacher, Frankfurt/Main
Fitted with JUNG LS 990 in white.

A classic shows its colours

Weissenhofsiedlung, Stuttgart
Architect: Le Corbusier

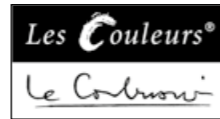
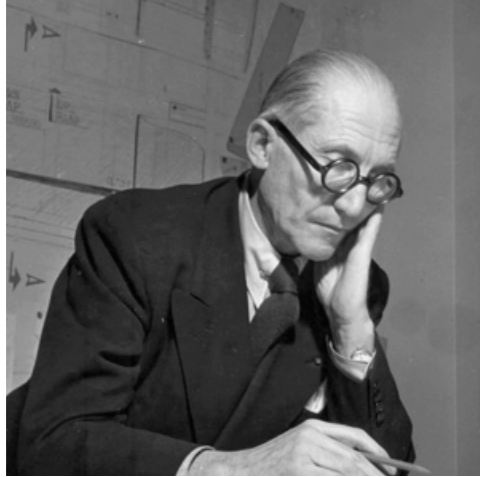

Colour is just as important for architecture as space or form. At least Swiss-French architect Le Corbusier (1887-1965), one of the most significant representatives of his craft in the 20th century, was convinced of that. With his visions and ideas and not least with his sculptural work he shaped the architecture of the Modern Age like hardly any other – and consequently also our ideas about construction to the present day. In addition to architecture,

Le Corbusier focused intensively on painting. He experimented with colour early on in his abstract paintings, above all with their effect on human perception. Thus over the decades he developed his own colour system: polychromie architecturale. It is a colour system geared specifically to architecture, and correspondingly only uses tones compatible with it. Moreover, Le Corbusier based his concept on the colours of nature and in such

“Colour in architecture – a means as powerful as the ground plan and section. Or better: polychromy, a component of the ground plan and the section itself.”

a way that each colour could be combined as desired with one of the others. This sets it apart from other colour systems. In his own projects too, the architect repeatedly made use of his colour theory. One key building in this regard is Maison La Roche in Paris, a residential building with integrated gallery, which Le Corbusier designed for an art collector between 1923 and 1925 and which was designated a UNESCO World Cultural

Heritage site in 2016. He masterfully implemented his own colour strategy here and impressively shows how, with the aid of colour, individual spaces can be optically expanded, interconnected or dialectically related. Colour should underscore, but never mask, a form's characteristics – Le Corbusier was convinced of that.



“Colour has strong effects.
Colour is a factor of our
existence.”

For some time now the products of various manufacturers in a whole range of sectors have been available with his fascinating colours as Les Couleurs® Le Corbusier. As an official partner of Les Couleurs Suisse, the global license holder, JUNG has, since 2014, been the world's exclusive provider of the LS 990 in the 63 unique colours: an innovation that was honoured that very same year by the German Design Council as “Best of Best” in the “Product” category with the iconic award's highest distinction. As such, together with the products of the other Les Couleurs network partners, the colours in an entire space can be harmoniously combined – from the flooring to the wall surfaces to the switches and sockets. Naturally a coloured switch, which features an elegant matte finish, can also simply be used as a special accent on a white wall. To achieve the depth of colour and matte finish, JUNG has the switches hand-painted using a special method. The resulting slightly rough surface also makes operating the switch itself a tactile experience. Alongside classic switches, sockets and dimmers, the company also offers operating elements for the regulation of room functions in the unique colour system. Meaning smart homes are now also possible in Les Couleurs® Le Corbusier. A classic is now showing its colours.

Another Venice, Venice

Architect: Marcante – Testa | UdA Architetti, Italy
Fitted with JUNG LS 990 in Les Couleurs® Le Corbusier

A switch conquers architecture



Giant's Causeway, Antrim

Architect: Heneghan Peng Architects, Ireland
Fitted with JUNG LS 990 in aluminium.



© NIK SCHÖLZEL

Christian Schittich, architect and specialist author

“There are things that fit in so naturally you hardly notice them. But once you do concern yourself with them they immediately catch your attention everywhere.”

This at least was the impression of the above author when, in the early 1990s, he was first conscious of discovering the LS 990 switch range by JUNG. This happened while he was involved in modernizing his own, recently purchased apartment in an old building in Munich's Olympic Village. “To save money we did almost everything ourselves: laid parquet flooring, tiled the bathroom, tore out walls, and altered windows. At some point we needed to tackle the wiring and looked for a suitable switch and socket system. Despite having several years' experience of planning and having dealt with all kinds of materials and construction products, we had next to no experience with light switches. So we didn't have a favourite product we had always wanted, as might be the case with other items such as a washstand or a dining room luminaire. Then one evening a neighbour, who was modernizing at the same time as us and a man with whom we regularly swapped tools or our experiences of doing alteration work, brought us a catalogue from an electrical supplies wholesale market and suggested we order items together. Even though the catalogue offered a vast number of options, we quickly found a suitable range. Without knowing that our choice was already a true classic, the LS 990 won us over immediately on account of its clear shape.” Once all the components had been ordered and installed the JUNG switches immediately stood out. At least they seemed to in almost every instance where the architecture was something really special. This was also true in the buildings by some of the most renowned members of the

profession, such as Richard Meier. The LS switches featured prominently in his much-acclaimed house in Ulm, as well as in various buildings by Norman Foster – at the time considered the undisputed king of architecture. A few years later Foster, who owed his fame to a number of iconic high-tech projects like the Hong Kong and Shanghai Bank headquarters or the new airport in Stansted, UK, ended the series with one of his most sensational projects: the conversion of Berlin's Reichstag to the new Bundestag with its walk-through glass dome, which today remains one of the capital's most popular tourist attractions. For this special building Foster wanted the switches and outlets in a sophisticated light grey, and got them from JUNG, who launched a new line with them. At almost the same time and at the request of another architect at Gruber + Kleine-Kraneburg a stainless steel version was produced for the Office of the Federal President. It would also become an established part of the range.

However, the Bundestag and Office of the Federal President are not the only buildings in Berlin's government district to use the LS 990. Indeed, the architects behind the Paul-Löbe-Haus (Stephan Braunfels), not to mention the Federal Foreign Office (Müller Reimann Architekten) also opted for it, as did HPP for the Federal Ministry of Finance. And shortly afterwards Kleihues + Kleihues would select it for the Federal Ministry of Labour and Social Affairs, for which a version in aluminium was introduced. Even the Federal Chancellor switches on the light in her official residence using the LS 990.

Town house, Ulm

Architect: Richard Meier, New York
Fitted with JUNG LS 990 in white.

A good 20 years have passed since the government district was built in Berlin. And architecture has seen many changes not only in a technical respect, but also as regards design.

Driven by rapid development, which produces ever new materials and construction methods, by digitization, globalization and the resulting global exchange of ideas and concepts, technologies and products, the architecture of the last two decades has demonstrated a previously unknown diversity. Advances in parametrics, for example, allow spectacular free forms, which would have been inconceivable not that long ago. And in their wish to realize "signature architecture" numerous designers and clients are only too happy to resort to them. Some architects orchestrate natural and artificial materials, others still tend to rely on minimalism and reduction. Everything seems possible today as long as quality is delivered. In this pluralist and fast-paced era it seems all the more surprising that one repeatedly comes across construction products that are ageless and that remain so popular despite all these changes. Indeed, you could argue that they even benefit from them. Such true classics include the LS 990 switch range by JUNG. Today, leading international architects continue to rely on it for a wide variety of projects, whether it is the new Pudong Shangri-La Hotel in Shanghai, the Allianz Arena in Munich or an extraordinary single-family house in Portugal. And it is still increasing in popularity.

"We selected the LS 990 system for the Fonte Boa House for its minimalist and unpretentious appearance and its high-quality materials," explains the architect João Mendes Ribeiro. "With its elementary form and extremely thin trim, it simply fits into every ambience."

Casa Fonte Boa, Portugal

Architect: João Mendes Ribeiro Arquitecto Lda, Portugal
Fitted with JUNG LS 990 in white.

David Chipperfield Architects also repeatedly favor switches by JUNG. Not only in their own office in Berlin, but also in David Chipperfield's Berlin apartment and in numerous other projects. One of them is the Ciutat de la Justícia in Barcelona, a seemingly casually composed complex of several exceedingly elegantly styled cube-shaped law court buildings, which differ in the various pastel shades used for their façades. "There are things which have found their shape and perhaps it is no longer worth giving them any further thought: the tail coat, top hat, the concert piano. And for me the LS 990 light switch by JUNG is one such item," says Alexander Schwarz, partner and Design Director at David Chipperfield

Architects Berlin. "All these things look best in black." In black, not for nothing occasionally described as the favourite colour of architects, the range has been around since the Cubus Hotel and office building in Düsseldorf (1998) by schneider+schumacher. Similarly, the Frankfurt duo has relied on the range on repeated occasions since first setting up their joint office in the late 1980s. One example is the extension of the Städel Museum in Frankfurt, which with its futuristic-looking circular skylights and green roof that children can play on when the weather is good is surely one of the most fascinating museums realized in Germany more recently.



“After all, with its pared-back form and ageless quality, the LS 990 simply suits any architecture.”

Designing a dentist's practice could not be much more different than planning a museum, and KU 64 in Berlin is the former. Moreover, the architectural language of its designers, the Berlin company Graft, is completely different from that of schneider+schumacher. But the two projects do have one thing in common: the switch system used. The planners at Graft also selected the LS 990 for their organic-looking interior landscape. Its unobtrusive design means it can be simply integrated into any setting, so it is hardly surprising this simplicity is also appreciated by those architects whose buildings stand out for their spectacular shapes. It stands to reason, as they of all people need switches and sockets that do not overly distract from their own sumptuous designs. As such, you also find the LS 990 in Frank Gehry's DZ Bank at the Brandenburg Gate in Berlin and in the BMW Welt in Munich by COOP HIMMELB(L)AU from Vienna. The interior of this showcase sculpture of steel and glass in particular really reveals all its splendor. It is an orchestrated world of

experience beneath a gigantic undulating roof, whose dynamic form represents the automobile corporation's top brands but in addition becomes a vibrant urban space for encounters at any time of night or day. And wherever various architects design parts of an ensemble, JUNG switches are popular. On the well-known Vitra Campus in Weil am Rhein, for example. Over the course of several years a wide range of big design names have left their mark in the form of individual structures: Zaha Hadid and Frank Gehry with their Deconstructivist architecture, Tadao Ando with his sensual Minimalism, Nicholas Grimshaw with his high-tech hall, and the partners at SANAA with their very white and filigree formal idiom. Alongside their location, what these structures have in common is the switch range. And that is nothing if not logical. “Because,” as Wolfram Putz, one of the three founder partners of Graft, says, “with its pared-back form and ageless quality, the LS 990 simply suits any architecture.”

DZ Bank, Berlin

Architect: Frank O. Gehry, Los Angeles
Fitted with JUNG LS 990 in stainless steel.



“When I was planning my first residential home in 1991 I thoroughly investigated ranges of switches and decided in favour of the LS 990. I was certain that a simple, elegant, and reduced form would survive over the years and blend in best with our contemporary, as well as timeless architecture. We have an important guideline in our studio: Something better is the enemy of something good! If though, as in the case of the LS, nothing better subsequently comes along, what is good remains the best. And so for the last 25 years we have been using the same switch range for all our projects.”

Alexander Brenner

Bathed in light and spread across three spacious levels, Haus Rottmann by Brenner Architekten stands for the very highest housing standards. Simplicity and high-end materials define its timeless design.

The entire interior, an integral part of the overall architecture, is the work of the same designers and was produced especially for this edifice. The LS 990 by JUNG blends in as a matter of course.



Haus Rottmann, Wiesbaden

Architect: Alexander Brenner Architekten, Stuttgart
Fitted with JUNG LS 990 in Les Couleurs® Le Corbusier.

In conversation with:
Wolfram Putz



Your company, Graft, has made a name for itself not just with its architecture but with several spectacular interior designs. What importance do light switches have for you?

Wolfram Putz: One shouldn't underestimate the significance of a light switch, as it offers a sensory or rather holistic experience thanks to its visual and haptic qualities. Alongside door handles and washstand mixers, it is one of the few products which forge a direct link between user and building.

What standards do you set for a good switch?

Wolfram Putz: For us, in addition to the aesthetic properties, it is key that the switch be timeless, simply be a classic. For the light switch and power sockets are among those things in a building that only very rarely get

replaced. Even door handles get changed more often. This may have to do with the higher investment costs, but also with the fact that you cannot install them yourself. Even if you do the complete outfit of your home yourself, the electricians always get installed by an electrician.

Let's move on to the LS 990 – why do you find it so impressive?

Wolfram Putz: To my mind, the JUNG switch is a successful example of an object for everyday use that, in line with the Bauhaus philosophy, has been pared down to its true essence, to the absolute essentials, and can thus be used in the most diverse architectural settings. We can deploy the system in an extremely organic interior design just as we can rely on it in relatively sober, precise and minimalist surrounds.

“One shouldn't underestimate the significance of a light switch, as it offers a sensory or rather holistic experience thanks to its visual and haptic qualities.”

We ourselves as architects cover a broad array of typologies and designs and we can use the switches everywhere. What we find so convincing is the product design itself: its angular shape, its visual precision and its details.

A true classic by Graft, an interior with a truly organic feeling, where you use the LS 990, is the KU 64 dental practice in Berlin, commissioned in 2005. What was the underlying design concept for it?

Wolfram Putz: The practice plays with the expectations of people who go to the dentist. To allay their fears of what lies ahead, it not only looks completely unlike conventional practices, but also provides an utterly different atmosphere. As soon as patients step through the door they enter an artificial world in which curved shapes and vibrant yellow-orange colours bring dunes and thus beaches to

mind. This kindles curiosity and a sense of playfulness and thus serves to distract. At the same time, it's all very open and spacious, quite unlike the usual constricting confines. Today, patients can still see from one end of the loft to the other. The individual cubicles where treatment is provided are more relaxed thanks to glass slits, and yet intimacy is preserved. The patient lying on the dentist's chair cannot be seen from outside but as soon as he or she stands up, there's an impression of transparency. All in all, it is an interior architecture that everyone can grasp – specialists and laypersons alike.

What were your criteria when choosing the range of switches for the practice?

Wolfram Putz: ZFirst of all, we needed very high-grade switches that fulfilled a kind of promise of precision. After all, a dentist works with high-quality materials and precise instruments. And alongside the very expensive dentist's chairs we wanted to place switches that were their equals.

Moreover, we wanted something timeless. Our design at the time was completely new and some considered it simply a fashionable gesture. Whereas we were from the outset convinced we had created something that would endure.

Looking back, the success proves us right. The practice has since spread through the building, and we've just finished commissioning the third expansion phase.

The interview was conducted by Christian Schittich, architect and specialist author.



KU64, Berlin

Architects: GRAFT Berlin

Fitted with JUNG LS 990 in white.

The company





The room is filled with the sounds of punching metal. In a consistent rhythm, the machine produces cover plates from stainless steel. A few meters further on, the accompanying socket inserts are assembled on one of the three fully automated production lines. At one station, in a typically jerky movement a robot grabs the tiny adjusting screws for the fastening claws and screws them tight. Right next to it though, manual work is still required. With a combination of machine and human, in a flexible assembly line more rarely requested

parts are assembled for each specific customer. "The island solutions enable us to produce even the smallest quantities immediately after the order comes in, and thus to provide a very broad range," explains plant manager Frank Ehrenthal. This whole spectacle is found at the power socket production facilities of the company Albrecht Jung in Schalksmühle. Every year, more than 14 million power socket inserts take shape along the fully automated production lines in the company's three plants.

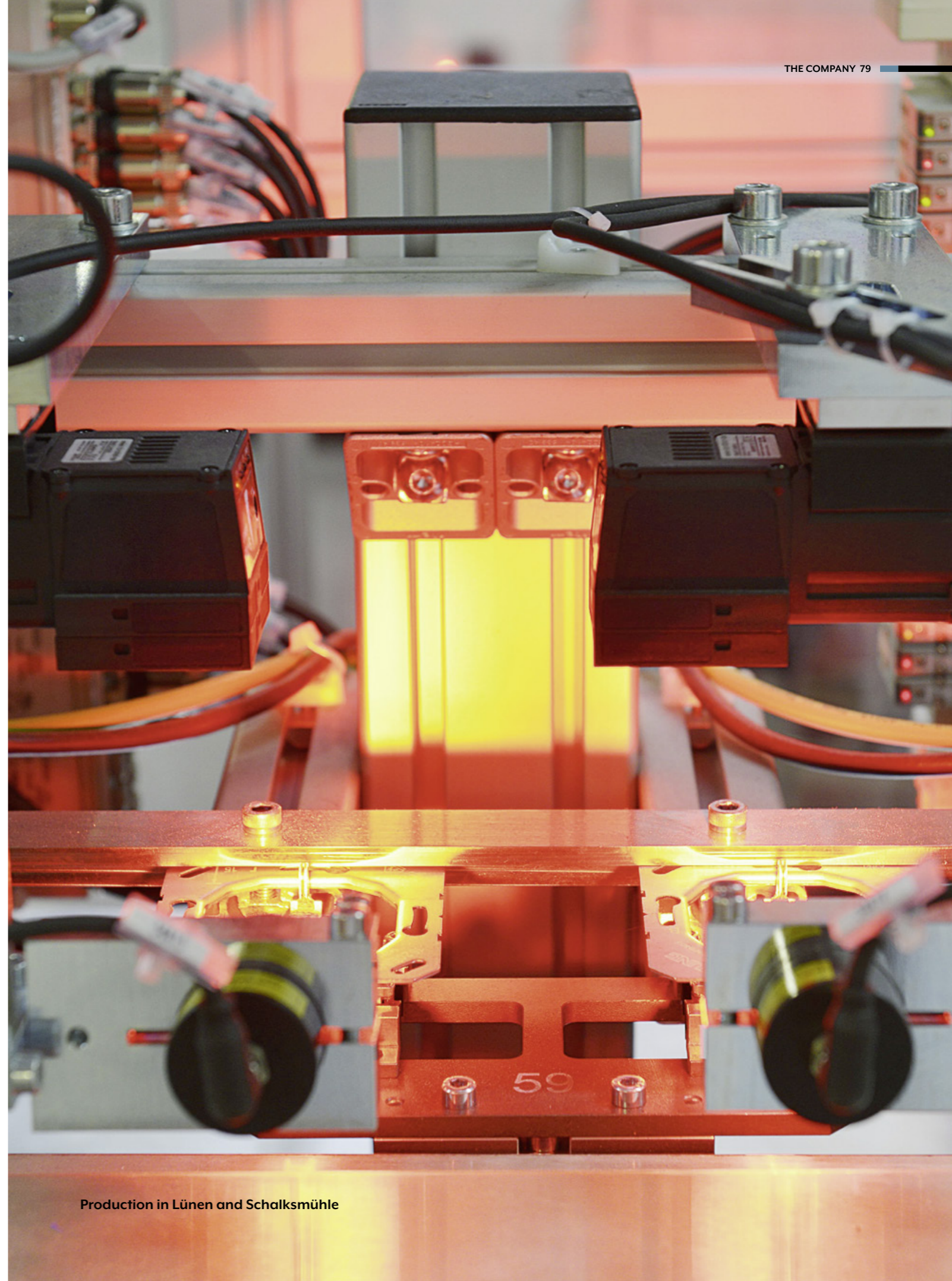

Production in Lünen and Schalksmühle

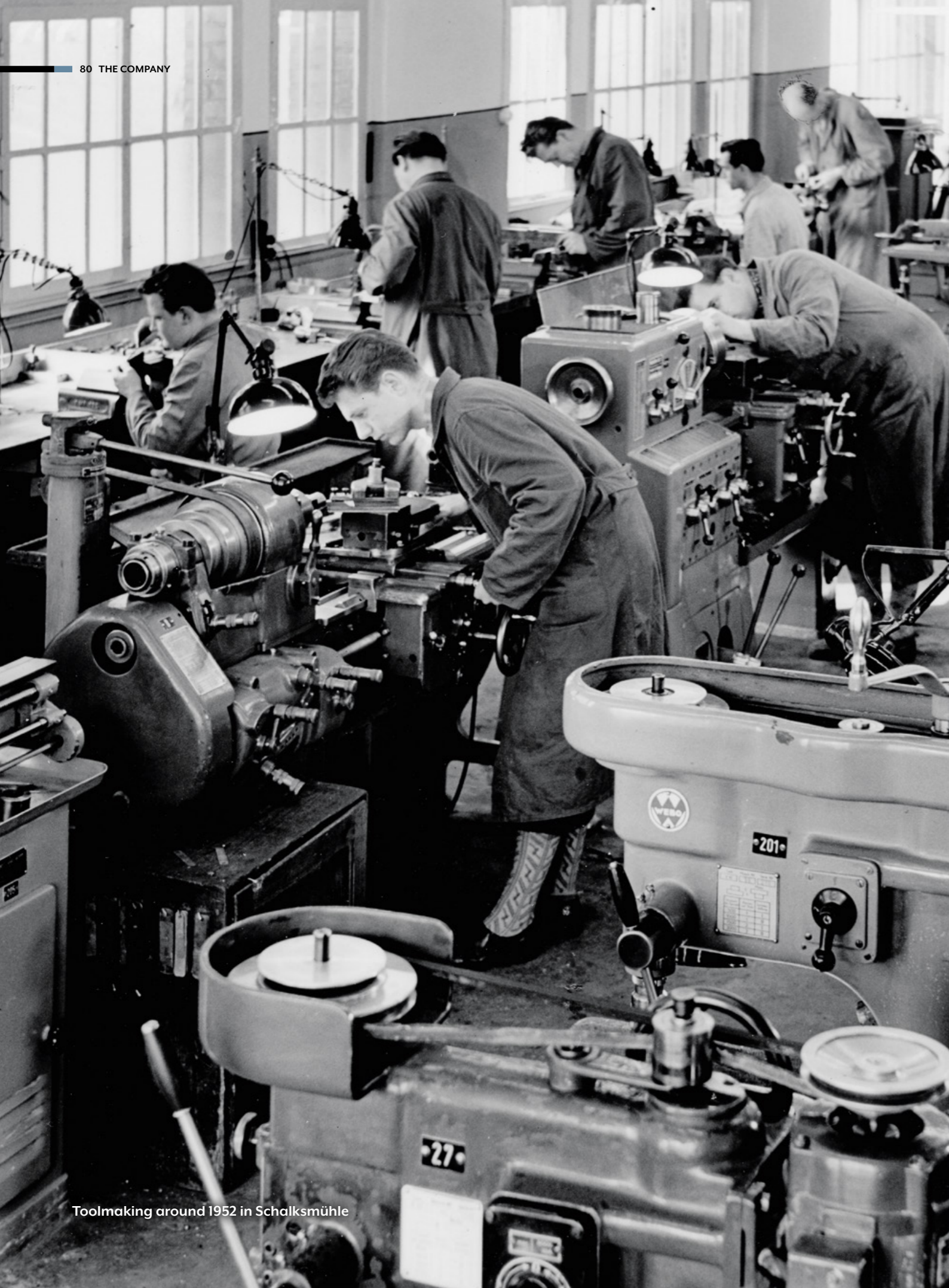

Toolmaking around 1952 in Schalksmühle

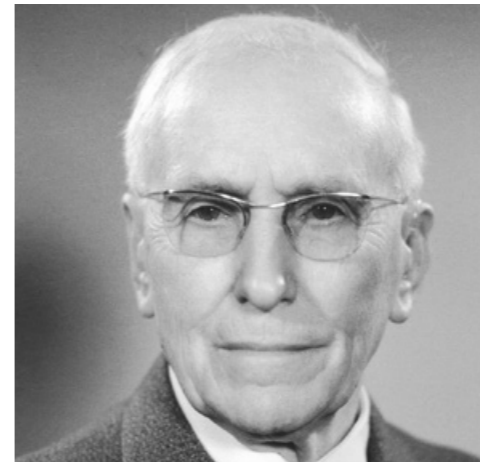

In 1912 Albrecht Jung, the company's founder and the character behind its name, set up his business in this quiet town in the Sauerland. Not far from the current location, in fact. During Jung's time, the main focus of the young company was his cutting-edge, patent-registered invention: the pull switch with 1/8 rotation. The innovative element of this was its particularly short switching distance – a principle that still forms the basis of all switch constructions by the company today. "My grandfather," explains Harald Jung, now director of the company and the third generation of the family to run it, "had previously been employed at Busch und Jäger in Schalksmühle as a foreman. He had lots of good ideas for innovations, which fell on deaf ears there, so he rented a greenhouse next door to his home and set about realizing his ideas for himself." It was a risk that would

pay off: Together with his subsequent partner Ernst Paris, Albrecht Jung quickly took his company to commercial success and ensured its survival even through tough times – two world wars and the later barren post-war years. In the 1960s the mantle was passed to the next generation in Siegfried Jung, who built up the lasting market success of the family-run company, which quickly began to specialize in the manufacture of switches and power sockets.

Notable product developments over the years played a crucial role here. Alongside a high standard of quality, the design factor has also become increasingly significant, and the LS 990, launched on the market in 1968, has been representative of the company like no other product.



Products “Made in Germany” – manufactured with precision



JUNG products are manufactured at the two company sites in Schalksmühle and Lünen. JUNG received the certificate “Made in Germany” from TÜV Nord in 2011 for this. With deep roots in the region and a constant employer for many decades, today customers throughout the world rely on the continuing high quality. At the same time, JUNG is aware of its high responsibility for sustainable and energy-efficient production.

JUNG has proven its specialist know-how in metalworking for decades. The company provides its switch designs in genuine metal. Matt finished or lacquered aluminium, stainless steel blasted with glass beads, brushed brass, chrome-plated metal or with almost 24 carat gold plating – JUNG produces precision switches down to the last detail every day.





“People come before switches.”

The company management remains convinced that the quality of the product goes hand in hand with the quality of the employees, and that a good working environment forms the basis for innovations at JUNG. The fact that JUNG is a family-run company creates the necessary scope here. After all, what counts in this company is not achieving maximum profits or working towards the next quarterly report, but rather long-term thinking, some-

times even over generations. The company's management is also very proud that over 90 percent of production takes place in Germany. After all, this is an important prerequisite for ensuring high quality standards and tremendous flexibility. And – not least – the “Made in Germany” seal of quality, so highly regarded abroad, does the export business no harm either.



JUNG worldwide

- | | |
|--------------|-----------|
| Bangkok | Moscow |
| Barcelona | New York |
| Colmar | Porto |
| Dubai | Seoul |
| Hong Kong | Shanghai |
| Istanbul | Singapore |
| Jakarta | Vienna |
| Kiev | Vilnius |
| Kuala Lumpur | |

JUNG's "Made in Germany" quality is highly regarded the world over. In order to do justice to the needs of customers internationally too, the family-run company has built up a global network: JUNG has subsidiaries in 17 countries and boasts a total of more than 70 representative agents on five continents. This way,

the company ensures its expertise is tailored to the various different requirements and standards, as well as country-specific particularities. For the users locally, this means a high level of certainty when dealing with JUNG's top-grade electrical products.

Sustainable operations

Protection of the climate and resources has long been a crucial topic, and sustainable operation is one of the greatest challenges of our time. At JUNG, it has always been a major focus – in fact, the approach of thinking in generations rather than short-term successes actually demands it. With its commitment to production exclusively in Germany, JUNG champions short channels as well as environmentally compatible production.

Moreover, the devices JUNG produces also contribute to climate protection. Indeed, intelligent controls for smart home application and KNX technology help to effectively reduce the amount of power required and thus CO2 emissions. The LS 990 is particularly suitable as a switch element for this.



In January 2009 JUNG was the first switch manufacturer to be made a member of the DGNB (German Sustainable Building Council). This way too, JUNG fosters long-term thinking and building.



Federal Environment Agency, Dessau
Architect: Sauerbruch Hutton, Berlin
Fitted with JUNG LS 990 in white.

Yesterday. Today. Tomorrow.

The LS 990 has remained up to date yet unchanged for 50 years in terms of both its design and its construction. Every technical innovation has been and continues to be integrated problem-free into the system, from simple surface switches for intelligent control panels for the different requirements through to a smart home with KNX. In design terms too, the LS 990 remains convincing today. With its timeless form, it fits into any room and thus claims its place as part of the architecture: yesterday, today and tomorrow.

ALBRECHT JUNG GMBH & CO. KG

P.O. Box 1320

58569 Schalksmühle

Germany

Phone +49 2355 806-553

Fax +49 2355 806-254

international@jung.de

For sales contacts in your country see:

jung-group.com/contact

JUNG-GROUP.COM