

# Produktu cenrādis

Cenas spēkā no 19.03.2024.

# Izmēru tabula

Visi norādītie izmēri attiecas uz ārējo rāmi, nevis uz stikla paketi (platums x augstums mm).

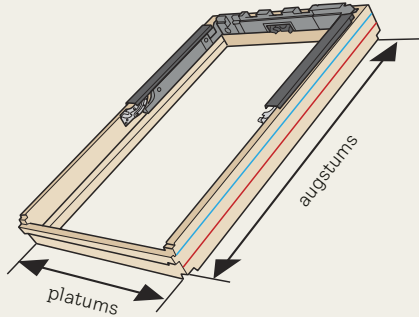

VELUX jumta loga modelis

GGL	GGU
GGL21	GGU21
GGL30	GGU30
GGL40D	GGU40D
GPL	GPU
GZL	GPU21
GLL	GLU

stiklojuma laukums, m<sup>2</sup>

(1,16)

SK08

VELUX jumta loga izmēra kods

## Jumta logi

550					GGL GGL21 GGL30 (0,27) <b>PK25</b>			
624				GGL (0,26) <b>MK27</b>				
698	GGL GGL21 (0,19) <b>CK01</b>					GGL GGL21 GGL30 (0,48) <b>SK01</b>		
778				GGL21 GGL GGL30 GZL GGL21 GLL GGL30 GGU GGU21 GLU GGL30 GLU21 (0,22) GLU30 <b>CK02</b>				
978	GGL GGL21 GGL30 (0,23) <b>BK04</b>	GGL GZL GGL21 GGU GGL30 GPL GGU21 GPU GGU30 GXU GLU/-B (0,29) <b>CK04</b>	GGL GGU GGL21 GGU21 GGL30 GGU30 GZL (0,38) <b>FK04</b>	GGL GGU GGL40D GPU GPL GPU21 GZL/-B GGL21 GGU21 GGL30 GGU30 GLU21 GLU30 (0,47) <b>MK04</b>	GGL GGL21 GGL30 (0,60) <b>PK04</b>		GGL GGL21 GGL30 GGL40D GPL (0,91) <b>UK04</b>	GGL GGL21 GGL30 GGL40D GPL (0,91) <b>UK04</b>
1178	GGL GPL GGL21 GGU GGL30 GPU GGU21 GXU GGU30 (0,37) <b>CK06</b>	GGL GPL GGL21 GGU GGL30 GPU GGU21 GXU GGU30 (0,47) <b>FK06</b>	GGL GGU GGL40D GGU40D GPL GPU21 GZL/-B GGL21 GGU21 GGL30 GGU30 GLU21 GLU30 (0,59) <b>MK06</b>	GGL GGL21 GGL30 GGL40D GPL (0,75) <b>PK06</b>	GGL GGL21 GGL30 GGL40D GPL (0,95) <b>SK06</b>	GGL GGL21 GGL30 GGL40D GPL (0,95) <b>SK06</b>	GGL GGL21 GGL30 GGL40D GPL (1,15) <b>UK06</b>	GGL GGL21 GGL30 GGL40D GPL (1,15) <b>UK06</b>
1398		GGL GGU GGL21 GGU21 GGL30 GGU30 GPL GPU GZL GPU21 GGL21 GGU21 GGL30 GGU30 GLU21 GLU30 (0,58) <b>FK08</b>	GGL GGU GGL40D GGU40D GPL GPU21 GZL/-B GGL21 GGU21 GGL30 GGU30 GLU21 GLU30 (0,72) <b>MK08</b>	GGL GGL21 GGL30 GGL40D GPL (0,92) <b>PK08</b>	GGL GGL21 GGL30 GGL40D GPL (1,16) <b>SK08</b>	GGL GGL21 GGL30 GGL40D GPL (1,16) <b>SK08</b>	GGL GGL21 GGL30 GGL40D GPL (1,40) <b>UK08</b>	GGL GGL21 GGL30 GGL40D GPL (1,40) <b>UK08</b>
1600			GGL GGU GGL21 GGU21 GGL30 GGU30 GPL GPU GZL GPU21 GGL21 GGU21 GGL30 GGU30 GLU21 GLU30 (0,85) <b>MK10</b>	GGL GGL21 GGL30 GGL40D GPL (1,07) <b>PK10</b>	GGL GGL21 GGL30 GGL40D GPL (1,35) <b>SK10</b>	GGL GGL21 GGL30 GGL40D GPL (1,35) <b>SK10</b>	GGL GGL21 GGL30 GGL40D GPL (1,63) <b>UK10</b>	GGL GGL21 GGL30 GGL40D GPL (1,63) <b>UK10</b>
1800			GGL GGL21 (0,97) <b>MK12</b>					
920			GIL GIU (0,34) <b>MK34</b>	GIL GIU (0,44) <b>PK34</b>	GIL GIU (0,70) <b>SK34</b>	GIL GIU (0,85) <b>UK34</b>		
601			VFE VIU (0,22) <b>MK31</b>	VFE VIU (0,28) <b>PK31</b>	VFE VIU (0,36) <b>SK31</b>	VFE VIU (0,43) <b>UK31</b>		
955			VFE VIU VFA VFB (0,44) <b>MK35</b>	VFE VIU VFA VFB (0,56) <b>PK35</b>	VFE VIU VFA VFB (0,70) <b>SK35</b>	VFE VIU VFA VFB (0,85) <b>UK35</b>		
1155			VFE VIU VFA VFB (0,56) <b>MK36</b>	VFE VIU VFA VFB (0,71) <b>PK36</b>	VFE VIU VFA VFB (0,89) <b>SK36</b>	VFE VIU VFA VFB (1,08) <b>UK36</b>		
1375			VFE VIU VFA VFB (0,69) <b>MK38</b>	VFE VIU VFA VFB (0,87) <b>PK38</b>	VFE VIU VFA VFB (1,10) <b>SK38</b>	VFE VIU VFA VFB (1,33) <b>UK38</b>		
	472	550	660	780	942	1140	1340	

Vērtība iekavās norāda logu stiklojuma laukumu m<sup>2</sup>

## Jumta balkons GDL

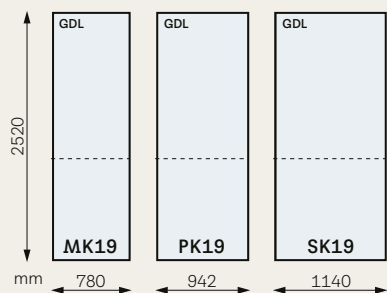

## Jumta terase GEL

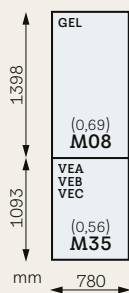

## VELUX GGLS trīs vienā

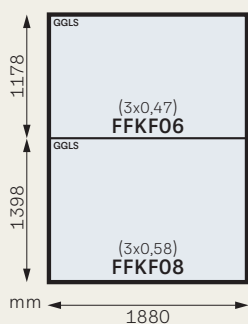

## Jumta lūkas

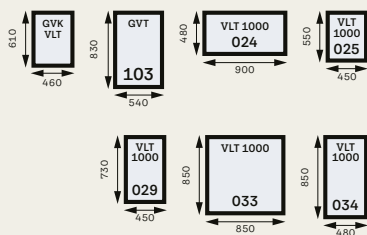

## Virsgaismas logi

600	CFP CVJ CVP CFU CFJ CVU 060060	CFJ CFU CVJ CVU 090060			CFU CVU 200060
800	CFP CFU CVP CVU CFJ CVJ 080080			CFU CVU 150080	
900	CFP CVP 060090	CFP CFU CVP CVU CFJ CVJ 090090		CFJ CVJ CFU CVU 120090	
1000		CFP CFJ CVP CVJ CXP CFU CSP CVU 100100		CFJ CVJ CFU CVU 150100	CFJ CVJ CFU CVU 200100
1200		CFP CVP CXP 090120	CFP CFJ CVP CVJ CXP CFU CSP CVU 120120	CFU CVU 150120	
1500		CFP CVP 100150		CFP CFU CVP CVU CFJ CVJ 150150	

- Jaunās paaudzes virsgaismas logs
- Virsgaismas logs ar kupolu
- Kupols

## Gaismas tuneļi

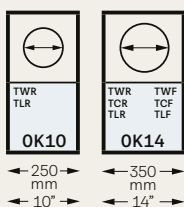

# Saturs

Stikla pakešu pārskats	4
Kombinētie pieslēgumi	6
Jumta logi	8
Jumta lūkas	18
Pieslēgumi iebūvēšanai slīpos jumtos	20
Produktu komplekti	44
Iebūvēšanas piederumi	48
Žalūzijas un slēgi	52
Elektriskie produkti	63
Produkti Velux jumta logu uzturēšanai un uzlabošanai	64
Gaismas tuneļi	66
Aksesuāri	67
Virsgaismas logi	68

Visas VELUX jumta logu uzlikas ir standarta pelēkā krāsā. Dažiem produktiem ir iespējams izvēlēties vara vai titāncinka uzlikas. Produktu veidi un cenu indeksi ir redzami tabulā. Lai iegūtu vairāk informācijas, lūdzu sazināties ar VELUX klientu servisu.

Standarta



Varš















Titāncinks



Ārējās uzlikas	Veids	Cenas indekss
<b>Premium jumta logi</b>		
Varš	GGL, GGU, GPL, GPU, GDL, GEL, VEA, VEB, VEC	170
Titāncinks	GGL, GGU, GPL, GPU, GDL, GEL, VEA, VEB, VEC	170
<b>Pieslēgumi</b>		
Varš	Paredzēts viena vai vairāku logu kombinētai iebūvēšanai	200
Titāncinks	Paredzēts viena vai vairāku logu kombinētai iebūvēšanai	160

# Stikla pakešu pārskats

		Standard	Standard Plus
<b>Stiklojums</b>	<b>51</b> 	<b>61</b> 	<b>64</b> 
	<b>VIENKAMERAS STIKLA PAKETE</b>	<b>ENERGOEFEKTIVITĀTE</b>	<b>ENERGO-EFEKTIVITĀTE UN KOMFORTS</b>
 Divkameru stikla pakete		✓	✓
 Aizsardzība pret aukstumu		✓	✓
 Skaņas izolācija		✓	✓
 Lietus trokšņa samazināšana			✓
 Laminēts stikls drošībai			
 Rūdīts stikls	✓	✓	✓
 UV filtrs			
 Pārklājums vieglākai tīrīšanai			✓
 Pretnorošanas pārklājums			
<b>U<sub>w</sub></b> Siltumizolācija (viss logs) (W/m <sup>2</sup> K)	<b>1,3</b>	<b>1,1</b>	<b>1,0</b>
<b>U<sub>g</sub></b> Siltumizolācija stiklam (W/m <sup>2</sup> K)	<b>1,0</b>	<b>0,6</b>	<b>0,6</b>
<b>g</b> Kopējā saules enerģijas caurlaidība (%)	<b>0,46</b>	<b>0,50</b>	<b>0,46</b>
<b>R<sub>w</sub></b> Skaņas izolācija (dB)	<b>31</b>	<b>32</b>	<b>35</b>
Gaisa caurlaidības klase	<b>3</b>	<b>4</b>	<b>4</b>
Gāze stikla paketes kamerā	<b>Argons</b>	<b>Argons</b>	<b>Argons</b>
<b>T<sub>v</sub></b> Gaismas caurlaidība	<b>0,69</b>	<b>0,68</b>	<b>0,62</b>
<b>T<sub>uv</sub></b> UV caurlaidība	<b>0,22</b>	<b>0,22</b>	<b>0,16</b>
Aizsardzība pret ielaušanos	-	-	-
Drošības klase	-	-	-
Stikla paketes uzbūve	4 mm stikls 16 mm Argons 4 mm rūdīts stikls	4 mm stikls 15 mm Argons 3 mm augstā temp. apstrādāts stikls 15 mm Argons 3 mm rūdīts stikls	6 mm stikls 13 mm Argons 3 mm augstā temp. apstrādāts stikls 13 mm Argons 4 mm rūdīts stikls

\* VELUX GGLS trīs vienā, GDL, GEL/VEA/VEB/VEC: lai saņemtu vairāk informācijas par tehniskajiem parametriem, lūdz sazināties ar klientu servisu.

\*\* GGL/GGU: U<sub>w</sub> = 0,92, GGL/GGU ar tāl vadību/GPU: U<sub>w</sub> = 0,96, GIL/GIU/VFE/VIU: U<sub>w</sub> = 1,0 (W/m<sup>2</sup>K)

## Priekšrocības



### Aizsardzība pret aukstumu

Patīkama iekštelpu temperatūra jebkādos laikapstākļos. Jo mazāka ir U vērtība, jo labāk.



### Skaņas izolācija

Jo mazāk trokšņa no ārpuses, jo vairāk miera un komforta mājās. Jo augstāka ir R<sub>w</sub> vērtība, jo labāk.



### Lietus trokšņa samazināšana

Netraucēts miegs bez lietus trokšņa aiz loga.



### Laminēts stikls drošībai

Novērš saplīsuša stikla iekrišanu telpā.

70	68	66	62	82
DROŠĪBA UN LIETUS TROKŠŅA SAMAZINĀŠANA	ENERGO-EFEKTIVITĀTE UN DROŠĪBA	ENERGO-EFEKTIVITĀTE UN SKAIDRS SKATS	ENERGO-EFEKTIVITĀTE UN SKAŅAS IZOLĀCIJA	PASĪVĀ MĀJA
	✓	✓	✓	✓
✓	✓	✓	✓	✓
✓	✓	✓	✓	✓
✓	✓	✓	✓	✓
✓	✓	✓	✓	✓
✓	✓	✓	✓	✓
✓	✓	✓	✓	✓
		✓		✓
		✓	✓	✓
1,3	1,1	1,0	0,92**	0,51
1,0	0,7	0,6	0,5	0,3
0,46	0,49	0,44	0,47	0,34
35	35	37	42	37
4	4	4	4	tbc
Argons	Argons	Argons	Kriptons	Kriptons
0,68	0,68	0,62	0,68	0,48
0,05	0,05	0,05	0,05	0,05
P2A	P2A	P2A	P2A	P2A
1B1	1B1	1B1	1B1	1B1

6.8 mm laminēts stikls  
16 mm Argons  
4 mm rūdīts stikls

6.8 mm laminēts stikls  
13 mm Argons  
3 mm augstā temp. apstrādāts stikls  
13 mm Argons  
4 mm rūdīts stikls

6.8 mm laminēts stikls  
13 mm Argons  
3 mm augstā temp. apstrādāts stikls  
13 mm Argons  
4 mm rūdīts stikls

6.8 mm laminēts stikls  
11 mm Kriptons  
3 mm augstā temp. apstrādāts stikls  
11 mm Kriptons  
8 mm rūdīts stikls

Iekšējā stikla pakete:  
6.8 mm laminēts stikls  
12 mm Kriptons  
3 mm augstā temp. apstrādāts stikls  
77,6 mm gaisa

Ārējā stikla pakete:  
3 mm augstā temp. apstrādāts stikls  
14 mm Kriptons  
3 mm augstā temp. apstrādāts stikls  
14 mm Kriptons  
4 mm rūdīts stikls



#### Rūdīts stikls

Piešķir stiprību ārējai rūtij, lai pasargātu no ekstremāliem laikapstākļiem, piemēram, spēcīgas vētras vai krusas.



#### UV filtrs

Aizsargā interjera mēbeles no izbalēšanas saules ietekmē un kaitīgajiem UV stariem.



#### Pašattīrošais pārklājums

Netīrumus atgrūdošs pārklājums ļauj veikt mazāk laika tīrīšanai un vairāk laika atpūtai.



#### Pretnorošanas pārklājums

Hidrofobs pārklājums samazina rasas daudzumu, kas var veidoties loga ārpusē, lai iegūtu skaidrāku skatu.

# Kombinētie pieslēgumi

Pieslēgumi paredzēti jumta logu iebūvēšanai blokos dažādās kombinācijās.

**Jumta logus GZL, GZL B, GLL, GLL B, GLU, GPL, GPU, GGL, GGU, GTL, GXL var iebūvēt jumtā neierobežotā skaitā.**

- VELUX uzņemas atbildību par iebūvēšanas piederumu kvalitāti un nosaka jaunu produkta standartu jumta logu kombinācijām.
- Jaunā platumā pielāgojamā savienojošā detaļa vienkāršo iebūvēšanu, izslēdzot nepareiza izmēra detaļas pasūtīšanas risku un samazinot vajadzību pēc laiktelpīgiem mērījumiem.
- VELUX platumā pielāgojamā savienojošā detaļa iekļauta

standarta iebūvēšanas līmeņa komplektos EKW, EKS, EKL, EKE. Standarta rāmja attālums „a” starp elementiem var būt 10–16 cm.

- Fiksēto savienojošo detaļu veidi iekļauti EKT un EKB komplektos. Standarta rāmja attālums „a” starp elementiem var būt E=10cm, F=12cm, G=14cm, H=16cm  
Viens blakus otram un viens virs otra risinājumiem pēdējais cipars kodā nozīmē elementa atrašanās vietu jumtā.

## Jumta logi viens blakus otram

### Divi logi viens blakus otram

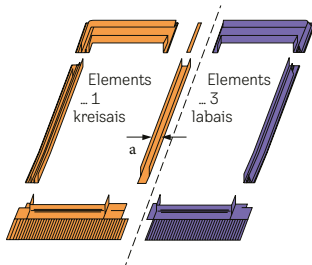

### Trīs logi viens blakus otram

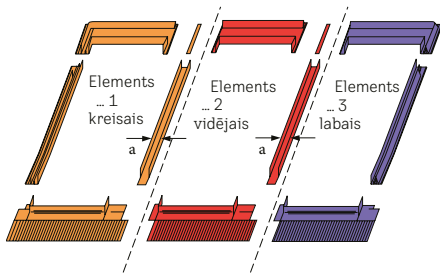

### Četri logi viens blakus otram

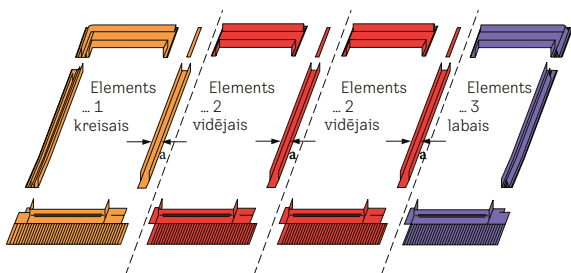

## Jumta logi viens virs otra

### Divi logi viens virs otra

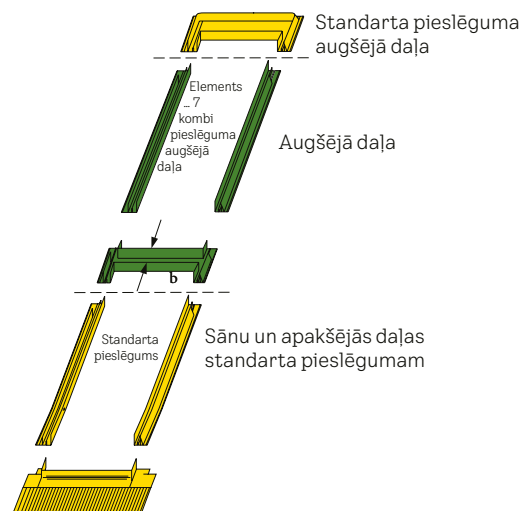

### Trīs logi viens virs otra

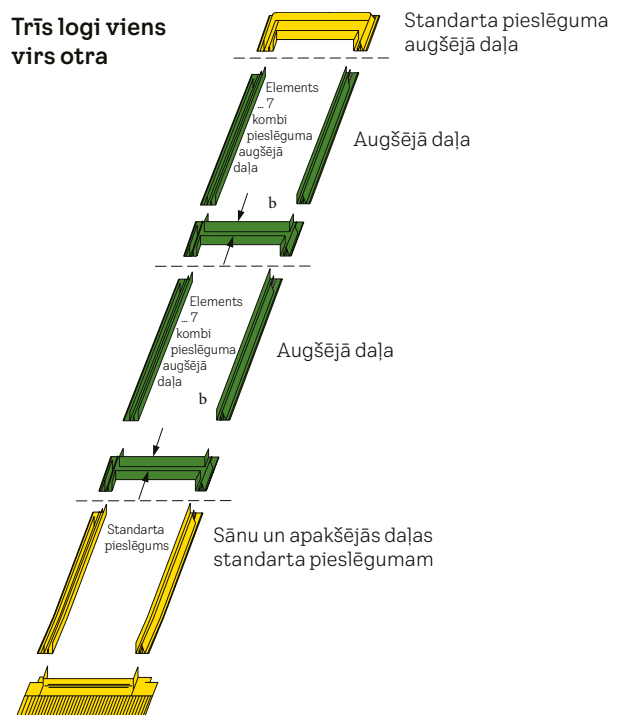

## Logi blakus un viens virs otra

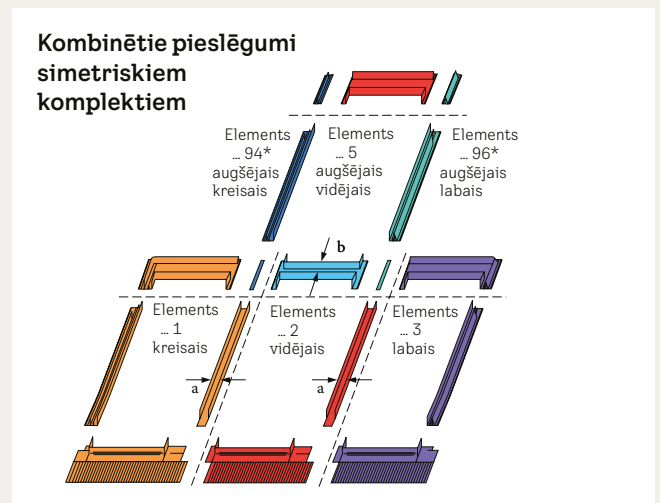
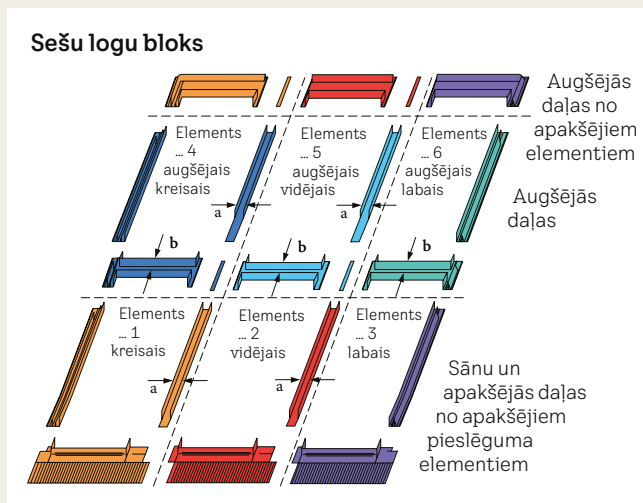
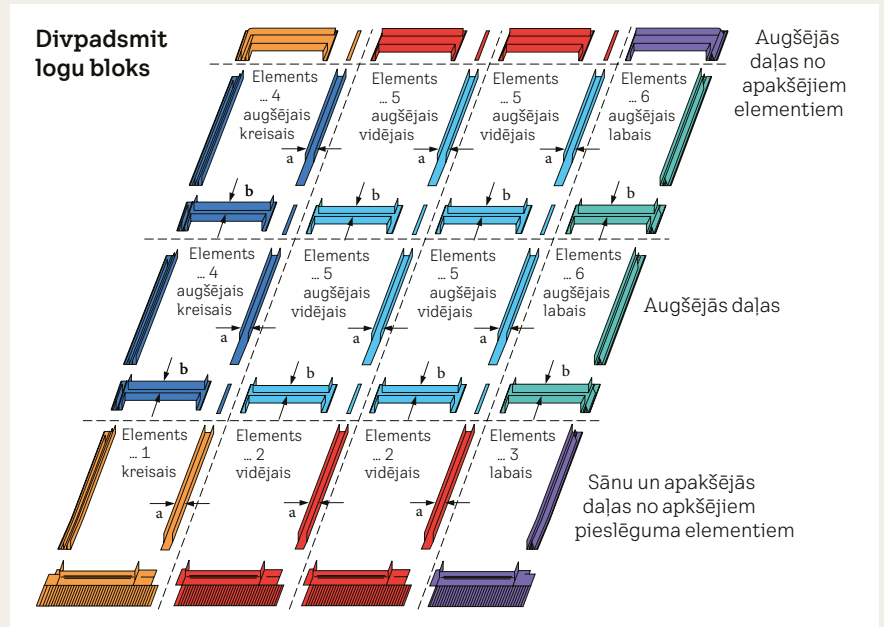
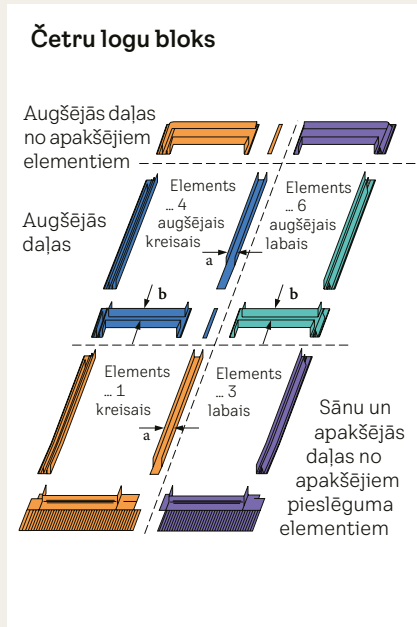

\*94. un 96. elements ir pieejami pasūtīšanai tikai kā speciālie materiāli.

## Padomi

- Elementu novietojums vienmēr tiek noteikts no ārpuses.
- Visiem logiem, kas atrodas blakus, ir jābūt vienādā garumā.
- Visiem logiem, kas atrodas viens virs otra, jābūt vienādā platumā.
- Jaunā platumā pielāgojamā savienojošā detaļa piemērota logu attālumam no 10 līdz 16 cm.

Loga platums cm (izmērs)	55 (C--)	66 (F--)	78 (M--)	94 (P--)	114 (S--)	134 (U--)
Ieteicamais attālums starp spārēm (cm) logam ar BDX komplektu	59-61	70-72	82-84	98-100	118-120	138-140

# Cenas

## JUMTA LOGI SLĪPAJIEM JUMTIEM



Cenas bez PVN, Eiro  
Cenas ar PVN, Eiro



CK02  
55x78



CK04  
55x98



FK04  
66x98



FK06  
66x118



FK08  
66x140



MK04  
78x98



MK06  
78x118



MK08  
78x140

### STANDARD, ROKTURIS VĒRTNES AUGŠĀ VAI APAKŠĀ

		W/(m <sup>2</sup> K) Iebūvēšanas slīpums										
<b>GZL 1051</b>	Verams ar roku, rokturis augšā, priedes koks, apstrādāts ar dubultu pārklājumu, caurspīdīgs lakojušs, vienkameras stikla pakete	1.3	15-90	228,93 <b>277,00</b>	243,80 <b>295,00</b>	271,07 <b>328,00</b>	282,64 <b>342,00</b>	309,92 <b>375,00</b>	276,86 <b>335,00</b>	300,83 <b>364,00</b>	321,49 <b>389,00</b>	
<b>GZL 1051B</b>	Verams ar roku, rokturis apakšā, priedes koks, apstrādāts ar dubultu pārklājumu, caurspīdīgs lakojušs, vienkameras stikla pakete	1.3	15-90	-	-	-	282,64 <b>342,00</b>	-	276,86 <b>335,00</b>	300,83 <b>364,00</b>	321,49 <b>389,00</b>	
<b>GLU 0051</b>	Verams ar roku, rokturis augšā, balts poliuretāns ap koka kodolu ar papildu izturīgu pārklājumu, vienkameras stikla pakete	1.3	15-90	285,95 <b>346,00</b>	-	-	353,72 <b>428,00</b>	387,60 <b>469,00</b>	346,28 <b>419,00</b>	376,03 <b>455,00</b>	402,48 <b>487,00</b>	
<b>GLU 0051B</b>	Verams ar roku, rokturis apakšā, balts poliuretāns ap koka kodolu ar papildu izturīgu pārklājumu, vienkameras stikla pakete	1.3	15-90	-	-	-	353,72 <b>428,00</b>	-	346,28 <b>419,00</b>	376,03 <b>455,00</b>	402,48 <b>487,00</b>	



Cenas bez PVN, Eiro  
Cenas ar PVN, Eiro



CK02  
55x78



CK04  
55x98



FK04  
66x98



FK06  
66x118



FK08  
66x140



MK04  
78x98



MK06  
78x118



MK08  
78x140

### STANDARD, ROKTURIS VĒRTNES AUGŠĀ VAI APAKŠĀ

		W/(m <sup>2</sup> K) Iebūvēšanas slīpums										
<b>GLL 1061</b>	Verams ar roku, rokturis augšā, priedes koks, apstrādāts ar dubultu pārklājumu, caurspīdīgs lakojušs, divkameru stikla pakete	1.1	15-90	285,95 <b>346,00</b>	304,96 <b>369,00</b>	338,84 <b>410,00</b>	353,72 <b>428,00</b>	387,60 <b>469,00</b>	346,28 <b>419,00</b>	376,03 <b>455,00</b>	402,48 <b>487,00</b>	
<b>GLL 1061B</b>	Verams ar roku, rokturis apakšā, priedes koks, apstrādāts ar dubultu pārklājumu, caurspīdīgs lakojušs, divkameru stikla pakete	1.1	15-90	-	304,96 <b>369,00</b>	-	353,72 <b>428,00</b>	387,60 <b>469,00</b>	346,28 <b>419,00</b>	376,03 <b>455,00</b>	402,48 <b>487,00</b>	
<b>GLU 0061</b>	Verams ar roku, rokturis augšā, balts poliuretāns ap koka kodolu ar papildu izturīgu pārklājumu, divkameru stikla pakete	1.1	15-90	357,02 <b>432,00</b>	380,99 <b>461,00</b>	-	442,15 <b>535,00</b>	484,30 <b>586,00</b>	432,23 <b>523,00</b>	470,25 <b>569,00</b>	503,31 <b>609,00</b>	
<b>GLU 0061B</b>	Verams ar roku, rokturis apakšā, balts poliuretāns ap koka kodolu ar papildu izturīgu pārklājumu, divkameru stikla pakete	1.1	15-90	-	380,99 <b>461,00</b>	-	442,15 <b>535,00</b>	484,30 <b>586,00</b>	432,23 <b>523,00</b>	470,25 <b>569,00</b>	503,31 <b>609,00</b>	



	MK10 78x160	PK06 94x118	PK08 94x140	SK06 114x118	SK08 114x140
	372,73 <b>451,00</b>	352,07 <b>426,00</b>	376,03 <b>455,00</b>	370,25 <b>448,00</b>	412,40 <b>499,00</b>
	372,73 <b>451,00</b>	352,07 <b>426,00</b>	376,03 <b>455,00</b>	-	-
	466,12 <b>564,00</b>	-	-	-	514,88 <b>623,00</b>
	-	-	470,25 <b>569,00</b>	-	-

	MK10 78x160	PK06 94x118	PK08 94x140	SK06 114x118	SK08 114x140
	466,12 <b>564,00</b>	439,67 <b>532,00</b>	470,25 <b>569,00</b>	462,81 <b>560,00</b>	514,88 <b>623,00</b>
	466,12 <b>564,00</b>	-	470,25 <b>569,00</b>	-	-
	582,64 <b>705,00</b>	-	587,60 <b>711,00</b>	-	643,80 <b>779,00</b>
	582,64 <b>705,00</b>	-	587,60 <b>711,00</b>	-	-

Jumta loga rāmja izmērs, cm	Senāka loga kods			Jaunākās paaudzes loga kods
	Ražots līdz 1992. gadam	Ražots līdz 2003. gadam	Ražots līdz 2014. gadam	Pieejams šobrīd
55 × 78	-	102	C02	<b>CK02</b>
55 × 98	6	104	C04	<b>CK04</b>
66 × 98	-	204	F04	<b>FK04</b>
66 × 118	-	206	F06	<b>FK06</b>
66 × 140	-	-	F08	<b>FK08</b>
70 × 118	5	-	-	<b>FK06*</b>
78 × 98	1	304	M04	<b>MK04</b>
78 × 118	14	306	M06	<b>MK06</b>
78 × 140	12	308	M08	<b>MK08</b>
78 × 160	13	310	M10	<b>MK10</b>
94 × 98	-	404	P04	<b>PK04</b>
94 × 118	-	406	P06	<b>PK06</b>
94 × 140	-	408	P08	<b>PK08</b>
94 × 160	13	410	P10	<b>PK10</b>
114 × 118	14	606	S06	<b>SK06</b>
114 × 140	10	608	S08	<b>SK08</b>
114 × 160	-	610	S10	<b>SK10</b>
134 × 98	-	804	U04	<b>UK04</b>
134 × 140	8	808	U08	<b>UK08</b>
134 × 160	-	810	U10	<b>UK10</b>

\* FK06 izmēra jumta logi ir 4 cm šaurāki nekā senākie jumta logi, kas ražoti līdz 1992. gadam.



Cenas bez PVN, Euro  
Cenas ar PVN, Euro



CK02 55x78	FK06 66x118	MK04 78x98	MK06 78x118	MK08 78x140	MK10 78x160	PK08 94x140	

### STANDARD ELEKTRISKIE/SOLĀRIE JUMTA LOGI AR TĀLVADĪBU

		W/(m <sup>2</sup> K) Iebūvēšanas slīpums									
<b>GLL 106121</b>	Elektrisks, priedes koks, apstrādāts ar dubultu pārklājumu, caurspīdīgs lakojušs, divkameru stikla pakete	1.1	15-90	657,85 <b>796,00</b>	725,62 <b>878,00</b>	718,18 <b>869,00</b>	747,93 <b>905,00</b>	774,38 <b>937,00</b>	838,02 <b>1 014,00</b>	842,15 <b>1 019,00</b>	
<b>GLL 106130</b>	Solārs, priedes koks, apstrādāts ar dubultu pārklājumu, caurspīdīgs lakojušs, divkameru stikla pakete	1.1	15-90	657,85 <b>796,00</b>	725,62 <b>878,00</b>	718,18 <b>869,00</b>	747,93 <b>905,00</b>	774,38 <b>937,00</b>	838,02 <b>1 014,00</b>	842,15 <b>1 019,00</b>	
<b>GLU 006121</b>	Elektrisks, balts poliuretāns ap koka kodolu ar papildu izturīgu pārklājumu, divkameru stikla pakete	1.1	15-90	728,93 <b>882,00</b>	814,05 <b>985,00</b>	804,13 <b>973,00</b>	842,15 <b>1 019,00</b>	875,21 <b>1 059,00</b>	954,55 <b>1 155,00</b>	959,50 <b>1 161,00</b>	
<b>GLU 006130</b>	Solārs, balts poliuretāns ap koka kodolu ar papildu izturīgu pārklājumu, divkameru stikla pakete	1.1	15-90	728,93 <b>882,00</b>	814,05 <b>985,00</b>	804,13 <b>973,00</b>	842,15 <b>1 019,00</b>	875,21 <b>1 059,00</b>	954,55 <b>1 155,00</b>	959,50 <b>1 161,00</b>	



Cenas bez PVN, Euro  
Cenas ar PVN, Euro

CK02 55x78	CK04 55x98	FK04 66x98	FK06 66x118	FK08 66x140	MK04 78x98	MK06 78x118	MK08 78x140	

### STANDARD PLUS, ROKTURIS VĒRTNES AUGŠĀ VAI APAKŠĀ

		W/(m <sup>2</sup> K) Iebūvēšanas slīpums										
<b>GLL 1064</b>	Verams ar roku, rokturis augšā, priedes koks, apstrādāts ar dubultu pārklājumu, caurspīdīgs lakojušs, divkameru stikla pakete	1.0	15-90	357,02 <b>432,00</b>	380,99 <b>461,00</b>	423,14 <b>512,00</b>	442,15 <b>535,00</b>	484,30 <b>586,00</b>	432,23 <b>523,00</b>	470,25 <b>569,00</b>	503,31 <b>609,00</b>	
<b>GLL 1064B</b>	Verams ar roku, rokturis apakšā, priedes koks, apstrādāts ar dubultu pārklājumu, caurspīdīgs lakojušs, divkameru stikla pakete	1.0	15-90	-	380,99 <b>461,00</b>	-	442,15 <b>535,00</b>	484,30 <b>586,00</b>	432,23 <b>523,00</b>	470,25 <b>569,00</b>	503,31 <b>609,00</b>	
<b>GLU 0064</b>	Verams ar roku, rokturis augšā, balts poliuretāns ap koka kodolu ar papildu izturīgu pārklājumu, divkameru stikla pakete	1.0	15-90	445,45 <b>539,00</b>	475,21 <b>575,00</b>	-	551,24 <b>667,00</b>	604,13 <b>731,00</b>	539,67 <b>653,00</b>	586,78 <b>710,00</b>	627,27 <b>759,00</b>	
<b>GLU 0064B</b>	Verams ar roku, rokturis apakšā, balts poliuretāns ap koka kodolu ar papildu izturīgu pārklājumu, divkameru stikla pakete	1.0	15-90	-	475,21 <b>575,00</b>	-	551,24 <b>667,00</b>	604,13 <b>731,00</b>	539,67 <b>653,00</b>	586,78 <b>710,00</b>	627,27 <b>759,00</b>	

	 MK10 78x160	 PK06 94x118	 PK08 94x140	 SK06 114x118	 SK08 114x140
	582,64 <b>705,00</b>	549,59 <b>665,00</b>	587,60 <b>711,00</b>	578,51 <b>700,00</b>	643,80 <b>779,00</b>
	582,64 <b>705,00</b>	-	587,60 <b>711,00</b>	-	-
	727,27 <b>880,00</b>	-	733,06 <b>887,00</b>	-	803,31 <b>972,00</b>
	727,27 <b>880,00</b>	-	733,06 <b>887,00</b>	-	-



Cenas bez PVN, Euro  
Cenas ar PVN, Euro



CK02  
55x78



CK04  
55x98



CK06  
55x118



FK04  
66x98



FK06  
66x118



FK08  
66x140



MK04  
78x98















MK06  
78x118

## PREMIUM, ROKTURIS VĒRTNES AUGŠĀ

W/(m<sup>2</sup> K) Iebūvēšanas  
slīpums

<b>GGL 3070</b>	Verams ar roku, rokturis augšā, priedes koks, apstrādāts ar trīskāršu pārklājumu, caurspīdīgs lakojums, vienkameras stikla pakete	1.3	15-90	309,92 <b>375,00</b>	330,58 <b>400,00</b>	367,77 <b>445,00</b>	367,77 <b>445,00</b>	383,47 <b>464,00</b>	420,66 <b>509,00</b>	375,21 <b>454,00</b>	408,26 <b>494,00</b>
<b>GGL 3070Q</b>	Verams ar roku, rokturis augšā, priedes koks, apstrādāts ar trīskāršu pārklājumu, caurspīdīgs lakojums, vienkameras stikla pakete	1.3	15-90	403,31 <b>488,00</b>	429,75 <b>520,00</b>	-	-	499,17 <b>604,00</b>	-	488,43 <b>591,00</b>	530,58 <b>642,00</b>
<b>GGL 3068</b>	Verams ar roku, rokturis augšā, priedes koks, apstrādāts ar trīskāršu pārklājumu, caurspīdīgs lakojums, divkameru stikla pakete	1.1	15-90	387,60 <b>469,00</b>	413,22 <b>500,00</b>	459,50 <b>556,00</b>	459,50 <b>556,00</b>	479,34 <b>580,00</b>	525,62 <b>636,00</b>	469,42 <b>568,00</b>	510,74 <b>618,00</b>
<b>GGL 3066</b>	Verams ar roku, rokturis augšā, priedes koks, apstrādāts ar trīskāršu pārklājumu, caurspīdīgs lakojums, divkameru stikla pakete	1.0	15-90	434,71 <b>526,00</b>	462,81 <b>560,00</b>	514,05 <b>622,00</b>	514,05 <b>622,00</b>	537,19 <b>650,00</b>	588,43 <b>712,00</b>	525,62 <b>636,00</b>	571,90 <b>692,00</b>
<b>GGL 3062</b>	Verams ar roku, rokturis augšā, priedes koks, apstrādāts ar trīskāršu pārklājumu, caurspīdīgs lakojums, divkameru stikla pakete	0.92	15-90	539,67 <b>653,00</b>	575,21 <b>696,00</b>	639,67 <b>774,00</b>	639,67 <b>774,00</b>	667,77 <b>808,00</b>	731,40 <b>885,00</b>	653,72 <b>791,00</b>	710,74 <b>860,00</b>
<b>GGU 0070</b>	Verams ar roku, rokturis augšā, balts poliuretāns ap koka kodolu ar papildu izturīgu pārklājumu, vienkameras stikla pakete	1.3	15-90	387,60 <b>469,00</b>	413,22 <b>500,00</b>	459,50 <b>556,00</b>	459,50 <b>556,00</b>	479,34 <b>580,00</b>	525,62 <b>636,00</b>	469,42 <b>568,00</b>	510,74 <b>618,00</b>
<b>GGU 0068</b>	Verams ar roku, rokturis augšā, balts poliuretāns ap koka kodolu ar papildu izturīgu pārklājumu, divkameru stikla pakete	1.1	15-90	485,12 <b>587,00</b>	516,53 <b>625,00</b>	574,38 <b>695,00</b>	574,38 <b>695,00</b>	600,00 <b>726,00</b>	657,02 <b>795,00</b>	586,78 <b>710,00</b>	638,02 <b>772,00</b>
<b>GGU 0066</b>	Verams ar roku, rokturis augšā, balts poliuretāns ap koka kodolu ar papildu izturīgu pārklājumu, divkameru stikla pakete	1.0	15-90	542,98 <b>657,00</b>	578,51 <b>700,00</b>	642,98 <b>778,00</b>	642,98 <b>778,00</b>	671,90 <b>813,00</b>	735,54 <b>890,00</b>	657,02 <b>795,00</b>	714,88 <b>865,00</b>
<b>GGU 0062</b>	Verams ar roku, rokturis augšā, balts poliuretāns ap koka kodolu ar papildu izturīgu pārklājumu, divkameru stikla pakete	0.92	15-90	675,21 <b>817,00</b>	719,01 <b>870,00</b>	799,17 <b>967,00</b>	799,17 <b>967,00</b>	834,71 <b>1 010,00</b>	914,88 <b>1 107,00</b>	816,53 <b>988,00</b>	887,60 <b>1 074,00</b>
<b>GGU 0070Q</b>	Verams ar roku, rokturis augšā, balts poliuretāns ap koka kodolu ar papildu izturīgu pārklājumu, vienkameras stikla pakete	1.3	15-90	504,13 <b>610,00</b>	537,19 <b>650,00</b>	-	596,69 <b>722,00</b>	623,97 <b>755,00</b>	-	610,74 <b>739,00</b>	663,64 <b>803,00</b>
<b>GGL 2070</b>	Verams ar roku, rokturis augšā, priedes koks, apstrādāts ar trīskāršu pārklājumu, balti krāsots, vienkameras stikla pakete	1.3	15-90	309,92 <b>375,00</b>	330,58 <b>400,00</b>	367,77 <b>445,00</b>	367,77 <b>445,00</b>	383,47 <b>464,00</b>	420,66 <b>509,00</b>	375,21 <b>454,00</b>	408,26 <b>494,00</b>
<b>GGL 2070Q</b>	Verams ar roku, rokturis augšā, priedes koks, apstrādāts ar trīskāršu pārklājumu, balti krāsots, vienkameras stikla pakete	1.3	15-90	403,31 <b>488,00</b>	429,75 <b>520,00</b>	-	477,69 <b>578,00</b>	499,17 <b>604,00</b>	-	488,43 <b>591,00</b>	530,58 <b>642,00</b>
<b>GGL 2068</b>	Verams ar roku, rokturis augšā, priedes koks, apstrādāts ar trīskāršu pārklājumu, balti krāsots, divkameru stikla pakete	1.1	15-90	387,60 <b>469,00</b>	413,22 <b>500,00</b>	459,50 <b>556,00</b>	459,50 <b>556,00</b>	479,34 <b>580,00</b>	525,62 <b>636,00</b>	469,42 <b>568,00</b>	510,74 <b>618,00</b>
<b>GGL 2066</b>	Verams ar roku, rokturis augšā, priedes koks, apstrādāts ar trīskāršu pārklājumu, balti krāsots, divkameru stikla pakete	1.0	15-90	434,71 <b>526,00</b>	462,81 <b>560,00</b>	514,05 <b>622,00</b>	514,05 <b>622,00</b>	537,19 <b>650,00</b>	588,43 <b>712,00</b>	525,62 <b>636,00</b>	571,90 <b>692,00</b>
<b>GGL 2062</b>	Verams ar roku, rokturis augšā, priedes koks, apstrādāts ar trīskāršu pārklājumu, balti krāsots, divkameru stikla pakete	0.92	15-90	539,67 <b>653,00</b>	575,21 <b>696,00</b>	639,67 <b>774,00</b>	639,67 <b>774,00</b>	667,77 <b>808,00</b>	731,40 <b>885,00</b>	653,72 <b>791,00</b>	710,74 <b>860,00</b>

 MK08 78x140	 MK10 78x160	 MK12 78x180	 PK06 94x118	 PK08 94x140	 PK10 94x160	 SK06 114x118	 SK08 114x140	 SK10 114x160	 UK04 134x98	 UK08 134x140	 UK10 134x160
437,19 <b>529,00</b>	506,61 <b>613,00</b>	576,03 <b>697,00</b>	477,69 <b>578,00</b>	510,74 <b>618,00</b>	551,24 <b>667,00</b>	502,48 <b>608,00</b>	559,50 <b>677,00</b>	620,66 <b>751,00</b>	514,05 <b>622,00</b>	624,79 <b>756,00</b>	702,48 <b>850,00</b>
567,77 <b>687,00</b>	657,85 <b>796,00</b>	-	620,66 <b>751,00</b>	663,64 <b>803,00</b>	716,53 <b>867,00</b>	652,89 <b>790,00</b>	727,27 <b>880,00</b>	806,61 <b>976,00</b>	668,60 <b>809,00</b>	812,40 <b>983,00</b>	913,22 <b>1 105,00</b>
546,28 <b>661,00</b>	633,06 <b>766,00</b>	719,83 <b>871,00</b>	596,69 <b>722,00</b>	638,02 <b>772,00</b>	689,26 <b>834,00</b>	628,10 <b>760,00</b>	699,17 <b>846,00</b>	776,03 <b>939,00</b>	642,98 <b>778,00</b>	780,99 <b>945,00</b>	877,69 <b>1 062,00</b>
611,57 <b>740,00</b>	709,09 <b>858,00</b>	805,79 <b>975,00</b>	668,60 <b>809,00</b>	714,88 <b>865,00</b>	771,90 <b>934,00</b>	703,31 <b>851,00</b>	782,64 <b>947,00</b>	868,60 <b>1 051,00</b>	719,83 <b>871,00</b>	874,38 <b>1 058,00</b>	983,47 <b>1 190,00</b>
760,33 <b>920,00</b>	880,99 <b>1 066,00</b>	-	831,40 <b>1 006,00</b>	887,60 <b>1 074,00</b>	958,68 <b>1 160,00</b>	873,55 <b>1 057,00</b>	973,55 <b>1 178,00</b>	-	-	-	-
546,28 <b>661,00</b>	633,06 <b>766,00</b>	-	596,69 <b>722,00</b>	638,02 <b>772,00</b>	689,26 <b>834,00</b>	628,10 <b>760,00</b>	699,17 <b>846,00</b>	776,03 <b>939,00</b>	642,98 <b>778,00</b>	780,99 <b>945,00</b>	877,69 <b>1 062,00</b>
682,64 <b>826,00</b>	790,91 <b>957,00</b>	-	746,28 <b>903,00</b>	797,52 <b>965,00</b>	861,16 <b>1 042,00</b>	784,30 <b>949,00</b>	873,55 <b>1 057,00</b>	969,42 <b>1 173,00</b>	804,13 <b>973,00</b>	976,03 <b>1 181,00</b>	1 097,52 <b>1 328,00</b>
764,46 <b>925,00</b>	885,95 <b>1 072,00</b>	-	835,54 <b>1 011,00</b>	893,39 <b>1 081,00</b>	964,46 <b>1 167,00</b>	878,51 <b>1 063,00</b>	978,51 <b>1 184,00</b>	1 085,95 <b>1 314,00</b>	900,00 <b>1 089,00</b>	1 093,39 <b>1 323,00</b>	1 228,93 <b>1 487,00</b>
950,41 <b>1 150,00</b>	1 100,83 <b>1 332,00</b>	-	1 038,84 <b>1 257,00</b>	1 109,92 <b>1 343,00</b>	1 199,17 <b>1 451,00</b>	1 092,56 <b>1 322,00</b>	1 216,53 <b>1 472,00</b>	-	-	-	-
709,92 <b>859,00</b>	822,31 <b>995,00</b>	-	776,03 <b>939,00</b>	828,93 <b>1 003,00</b>	895,87 <b>1 084,00</b>	815,70 <b>987,00</b>	909,09 <b>1 100,00</b>	-	835,54 <b>1 011,00</b>	1 014,88 <b>1 228,00</b>	-
437,19 <b>529,00</b>	506,61 <b>613,00</b>	576,03 <b>697,00</b>	477,69 <b>578,00</b>	510,74 <b>618,00</b>	551,24 <b>667,00</b>	502,48 <b>608,00</b>	559,50 <b>677,00</b>	620,66 <b>751,00</b>	514,05 <b>622,00</b>	624,79 <b>756,00</b>	702,48 <b>850,00</b>
567,77 <b>687,00</b>	657,85 <b>796,00</b>	-	620,66 <b>751,00</b>	663,64 <b>803,00</b>	716,53 <b>867,00</b>	652,89 <b>790,00</b>	727,27 <b>880,00</b>	806,61 <b>976,00</b>	668,60 <b>809,00</b>	812,40 <b>983,00</b>	913,22 <b>1 105,00</b>
546,28 <b>661,00</b>	633,06 <b>766,00</b>	719,83 <b>871,00</b>	596,69 <b>722,00</b>	638,02 <b>772,00</b>	689,26 <b>834,00</b>	628,10 <b>760,00</b>	699,17 <b>846,00</b>	776,03 <b>939,00</b>	642,98 <b>778,00</b>	780,99 <b>945,00</b>	877,69 <b>1 062,00</b>
611,57 <b>740,00</b>	709,09 <b>858,00</b>	805,79 <b>975,00</b>	668,60 <b>809,00</b>	714,88 <b>865,00</b>	771,90 <b>934,00</b>	703,31 <b>851,00</b>	782,64 <b>947,00</b>	868,60 <b>1 051,00</b>	719,83 <b>871,00</b>	874,38 <b>1 058,00</b>	983,47 <b>1 190,00</b>
760,33 <b>920,00</b>	880,99 <b>1 066,00</b>	-	831,40 <b>1 006,00</b>	887,60 <b>1 074,00</b>	958,68 <b>1 160,00</b>	873,55 <b>1 057,00</b>	973,55 <b>1 178,00</b>	-	-	-	-



Cenas bez PVN, Eiro  
Cenas ar PVN, Eiro

CK04  
55x98

CK06  
55x118

FK06  
66x118

FK08  
66x140

MK04  
78x98

MK06  
78x118







MK08  
78x140

MK10  
78x160

## PREMIUM, ROKTURIS VĒRTNES AUGŠĀ UN APAKŠĀ

		W/(m² K) Iebūvēšanas slīpums											
<b>GPL 3070</b>	Verams ar roku, rokturis apakšā, pa augšējo asi verams, priedes koks, apstrādāts ar trīskāršu pārklājumu, caurspīdīgs lakojušs, vienkameras stikla pakete	1.3	15-55	530,58 <b>642,00</b>	567,77 <b>687,00</b>	583,47 <b>706,00</b>	620,66 <b>751,00</b>	575,21 <b>696,00</b>	608,26 <b>736,00</b>	637,19 <b>771,00</b>	706,61 <b>855,00</b>		
<b>GPL 3068</b>	Verams ar roku, rokturis apakšā, pa augšējo asi verams, priedes koks, apstrādāts ar trīskāršu pārklājumu, caurspīdīgs lakojušs, divkameru stikla pakete	1.1	15-55	613,22 <b>742,00</b>	659,50 <b>798,00</b>	679,34 <b>822,00</b>	725,62 <b>878,00</b>	669,42 <b>810,00</b>	710,74 <b>860,00</b>	746,28 <b>903,00</b>	833,06 <b>1 008,00</b>		
<b>GPL 3066</b>	Verams ar roku, rokturis apakšā, pa augšējo asi verams, priedes koks, apstrādāts ar trīskāršu pārklājumu, caurspīdīgs lakojušs, divkameru stikla pakete	1.0	15-55	662,81 <b>802,00</b>	714,05 <b>864,00</b>	737,19 <b>892,00</b>	788,43 <b>954,00</b>	725,62 <b>878,00</b>	771,90 <b>934,00</b>	811,57 <b>982,00</b>	909,09 <b>1 100,00</b>		
<b>GPU 0070</b>	Verams ar roku, rokturis apakšā, pa augšējo asi verams, balts poliuretāns ap koka kodolu ar papildu izturīgu pārklājumu, vienkameras stikla pakete	1.3	15-55	613,22 <b>742,00</b>	659,50 <b>798,00</b>	679,34 <b>822,00</b>	725,62 <b>878,00</b>	669,42 <b>810,00</b>	710,74 <b>860,00</b>	746,28 <b>903,00</b>	833,06 <b>1 008,00</b>		
<b>GPU 0068</b>	Verams ar roku, rokturis apakšā, pa augšējo asi verams, balts poliuretāns ap koka kodolu ar papildu izturīgu pārklājumu, divkameru stikla pakete	1.1	15-55	716,53 <b>867,00</b>	774,38 <b>937,00</b>	800,00 <b>968,00</b>	857,02 <b>1 037,00</b>	786,78 <b>952,00</b>	838,02 <b>1 014,00</b>	882,64 <b>1 068,00</b>	990,91 <b>1 199,00</b>		
<b>GPU 0066</b>	Verams ar roku, rokturis apakšā, pa augšējo asi verams, balts poliuretāns ap koka kodolu ar papildu izturīgu pārklājumu, divkameru stikla pakete	1.0	15-55	778,51 <b>942,00</b>	842,98 <b>1 020,00</b>	871,90 <b>1 055,00</b>	935,54 <b>1 132,00</b>	857,02 <b>1 037,00</b>	914,88 <b>1 107,00</b>	964,46 <b>1 167,00</b>	1 085,95 <b>1 314,00</b>		
<b>GPU 0062</b>	Verams ar roku, rokturis apakšā, pa augšējo asi verams, balts poliuretāns ap koka kodolu ar papildu izturīgu pārklājumu, divkameru stikla pakete	0.96	15-55	919,01 <b>1 112,00</b>	999,17 <b>1 209,00</b>	1 034,71 <b>1 252,00</b>	1 114,88 <b>1 349,00</b>	1 016,53 <b>1 230,00</b>	1 087,60 <b>1 316,00</b>	1 150,41 <b>1 392,00</b>	1 300,83 <b>1 574,00</b>		
<b>GPL 2070</b>	Verams ar roku, rokturis apakšā, pa augšējo asi verams, priedes koks, apstrādāts ar trīskāršu pārklājumu, balti krāsots, vienkameras stikla pakete	1.3	15-55	530,58 <b>642,00</b>	567,77 <b>687,00</b>	583,47 <b>706,00</b>	620,66 <b>751,00</b>	575,21 <b>696,00</b>	608,26 <b>736,00</b>	637,19 <b>771,00</b>	706,61 <b>855,00</b>		
<b>GPL 2068</b>	Verams ar roku, rokturis apakšā, pa augšējo asi verams, priedes koks, apstrādāts ar trīskāršu pārklājumu, balti krāsots, divkameru stikla pakete	1.1	15-55	613,22 <b>742,00</b>	659,50 <b>798,00</b>	679,34 <b>822,00</b>	725,62 <b>878,00</b>	669,42 <b>810,00</b>	710,74 <b>860,00</b>	746,28 <b>903,00</b>	833,06 <b>1 008,00</b>		
<b>GPL 2066</b>	Verams ar roku, rokturis apakšā, pa augšējo asi verams, priedes koks, apstrādāts ar trīskāršu pārklājumu, balti krāsots, divkameru stikla pakete	1.0	15-55	662,81 <b>802,00</b>	714,05 <b>864,00</b>	737,19 <b>892,00</b>	788,43 <b>954,00</b>	725,62 <b>878,00</b>	771,90 <b>934,00</b>	811,57 <b>982,00</b>	909,09 <b>1 100,00</b>		

Pa augšējo asi veramie jumta logi ir aprīkoti arī ar eņģi pa vidu, kas atvieglo loga vērtnes pagriešanu tīrīšanai.

	 PK06 94x118	 PK08 94x140	 PK10 94x160	 SK06 114x118	 SK08 114x140	 SK10 114x160	 UK04 134x98	 UK08 134x140
	677,69 <b>820,00</b>	710,74 <b>860,00</b>	751,24 <b>909,00</b>	702,48 <b>850,00</b>	759,50 <b>919,00</b>	820,66 <b>993,00</b>	714,05 <b>864,00</b>	824,79 <b>998,00</b>
	796,69 <b>964,00</b>	838,02 <b>1 014,00</b>	889,26 <b>1 076,00</b>	828,10 <b>1 002,00</b>	899,17 <b>1 088,00</b>	976,03 <b>1 181,00</b>	842,98 <b>1 020,00</b>	980,99 <b>1 187,00</b>
	868,60 <b>1 051,00</b>	914,88 <b>1 107,00</b>	971,90 <b>1 176,00</b>	903,31 <b>1 093,00</b>	982,64 <b>1 189,00</b>	1 068,60 <b>1 293,00</b>	919,83 <b>1 113,00</b>	1 074,38 <b>1 300,00</b>
	796,69 <b>964,00</b>	838,02 <b>1 014,00</b>	889,26 <b>1 076,00</b>	828,10 <b>1 002,00</b>	899,17 <b>1 088,00</b>	976,03 <b>1 181,00</b>	-	980,99 <b>1 187,00</b>
	946,28 <b>1 145,00</b>	997,52 <b>1 207,00</b>	1 061,16 <b>1 284,00</b>	984,30 <b>1 191,00</b>	1 073,55 <b>1 299,00</b>	1 169,42 <b>1 415,00</b>	-	1 176,03 <b>1 423,00</b>
	1 035,54 <b>1 253,00</b>	1 093,39 <b>1 323,00</b>	1 164,46 <b>1 409,00</b>	1 078,51 <b>1 305,00</b>	1 178,51 <b>1 426,00</b>	1 285,95 <b>1 556,00</b>	-	1 293,39 <b>1 565,00</b>
	1 238,84 <b>1 499,00</b>	1 309,92 <b>1 585,00</b>	1 399,17 <b>1 693,00</b>	1 292,56 <b>1 564,00</b>	1 416,53 <b>1 714,00</b>	-	-	-
	677,69 <b>820,00</b>	710,74 <b>860,00</b>	751,24 <b>909,00</b>	702,48 <b>850,00</b>	759,50 <b>919,00</b>	820,66 <b>993,00</b>	714,05 <b>864,00</b>	824,79 <b>998,00</b>
	796,69 <b>964,00</b>	838,02 <b>1 014,00</b>	889,26 <b>1 076,00</b>	828,10 <b>1 002,00</b>	899,17 <b>1 088,00</b>	976,03 <b>1 181,00</b>	842,98 <b>1 020,00</b>	980,99 <b>1 187,00</b>
	868,60 <b>1 051,00</b>	914,88 <b>1 107,00</b>	971,90 <b>1 176,00</b>	903,31 <b>1 093,00</b>	982,64 <b>1 189,00</b>	1 068,60 <b>1 293,00</b>	919,83 <b>1 113,00</b>	1 074,38 <b>1 300,00</b>



Cenas bez PVN, Eiro  
Cenas ar PVN, Eiro



CK02  
55x78



CK04  
55x98



CK06  
55x118



FK04  
66x98



FK06  
66x118



FK08  
66x140



MK04  
78x98













MK06  
78x118

## JUMTA LOGI AR TĀLVADĪBU

W/(m<sup>2</sup> K) Iebūvēšanas  
slīpums

<b>GGL 307021</b>	Elektrisks, priedes koks, apstrādāts ar trīskāršu pārklājumu, caurspīdīgs lakoājums, vienkameru stikla pakete	1.3	15-90	-	-	-	-	-	-	-	-	-
<b>GGL 306821</b>	Elektrisks, priedes koks, apstrādāts ar trīskāršu pārklājumu, caurspīdīgs lakoājums, divkameru stikla pakete	1.1	15-90	763,64 <b>924,00</b>	789,26 <b>955,00</b>	835,54 <b>1 011,00</b>	835,54 <b>1 011,00</b>	855,37 <b>1 035,00</b>	901,65 <b>1 091,00</b>	845,45 <b>1 023,00</b>	886,78 <b>1 073,00</b>	
<b>GGL 306621</b>	Elektrisks, priedes koks, apstrādāts ar trīskāršu pārklājumu, caurspīdīgs lakoājums, divkameru stikla pakete	1.0	15-90	810,74 <b>981,00</b>	838,84 <b>1 015,00</b>	890,08 <b>1 077,00</b>	890,08 <b>1 077,00</b>	913,22 <b>1 105,00</b>	964,46 <b>1 167,00</b>	901,65 <b>1 091,00</b>	947,93 <b>1 147,00</b>	
<b>GGL 306221</b>	Elektrisks, priedes koks, apstrādāts ar trīskāršu pārklājumu, caurspīdīgs lakoājums, divkameru stikla pakete	0.96	15-90	915,70 <b>1 108,00</b>	951,24 <b>1 151,00</b>	1 015,70 <b>1 229,00</b>	1 015,70 <b>1 229,00</b>	1 043,80 <b>1 263,00</b>	1 107,44 <b>1 340,00</b>	1 029,75 <b>1 246,00</b>	1 086,78 <b>1 315,00</b>	
<b>GGL 306830</b>	Solārs, priedes koks, apstrādāts ar trīskāršu pārklājumu, caurspīdīgs lakoājums, divkameru stikla pakete	1.1	15-90	763,64 <b>924,00</b>	789,26 <b>955,00</b>	835,54 <b>1 011,00</b>	-	855,37 <b>1 035,00</b>	901,65 <b>1 091,00</b>	845,45 <b>1 023,00</b>	886,78 <b>1 073,00</b>	
<b>GGL 306630</b>	Solārs, priedes koks, apstrādāts ar trīskāršu pārklājumu, caurspīdīgs lakoājums, divkameru stikla pakete	1.0	15-90	810,74 <b>981,00</b>	838,84 <b>1 015,00</b>	890,08 <b>1 077,00</b>	-	913,22 <b>1 105,00</b>	964,46 <b>1 167,00</b>	901,65 <b>1 091,00</b>	947,93 <b>1 147,00</b>	
<b>GGU 006821</b>	Elektrisks, balts poliuretāns ap koka kodolu ar papildu izturīgu pārklājumu, divkameru stikla pakete	1.1	15-90	861,16 <b>1 042,00</b>	892,56 <b>1 080,00</b>	950,41 <b>1 150,00</b>	950,41 <b>1 150,00</b>	976,03 <b>1 181,00</b>	1 033,06 <b>1 250,00</b>	962,81 <b>1 165,00</b>	1 014,05 <b>1 227,00</b>	
<b>GGU 006621</b>	Elektrisks, balts poliuretāns ap koka kodolu ar papildu izturīgu pārklājumu, divkameru stikla pakete	1.0	15-90	919,01 <b>1 112,00</b>	954,55 <b>1 155,00</b>	1 019,01 <b>1 233,00</b>	1 019,01 <b>1 233,00</b>	1 047,93 <b>1 268,00</b>	1 111,57 <b>1 345,00</b>	1 033,06 <b>1 250,00</b>	1 090,91 <b>1 320,00</b>	
<b>GGU 006221</b>	Elektrisks, balts poliuretāns ap koka kodolu ar papildu izturīgu pārklājumu, divkameru stikla pakete	0.96	15-90	1 051,24 <b>1 272,00</b>	1 095,04 <b>1 325,00</b>	1 175,21 <b>1 422,00</b>	1 175,21 <b>1 422,00</b>	1 210,74 <b>1 465,00</b>	1 290,91 <b>1 562,00</b>	1 192,56 <b>1 443,00</b>	1 263,64 <b>1 529,00</b>	
<b>GGU 006830</b>	Solārs, balts poliuretāns ap koka kodolu ar papildu izturīgu pārklājumu, divkameru stikla pakete	1.1	15-90	861,16 <b>1 042,00</b>	892,56 <b>1 080,00</b>	950,41 <b>1 150,00</b>	-	976,03 <b>1 181,00</b>	1 033,06 <b>1 250,00</b>	962,81 <b>1 165,00</b>	1 014,05 <b>1 227,00</b>	
<b>GGU 006630</b>	Solārs, balts poliuretāns ap koka kodolu ar papildu izturīgu pārklājumu, divkameru stikla pakete	1.0	15-90	919,01 <b>1 112,00</b>	954,55 <b>1 155,00</b>	1 019,01 <b>1 233,00</b>	-	1 047,93 <b>1 268,00</b>	1 111,57 <b>1 345,00</b>	1 033,06 <b>1 250,00</b>	1 090,91 <b>1 320,00</b>	
<b>GPU 006621</b>	Elektrisks, balts poliuretāns ap koka kodolu ar papildu izturīgu pārklājumu, divkameru stikla pakete	1.0	15-65	-	-	-	-	1 362,81 <b>1 649,00</b>	1 426,45 <b>1 726,00</b>	-	1 405,79 <b>1 701,00</b>	



	 MK08 78x140	 MK10 78x160	 PK06 94x118	 PK08 94x140	 PK10 94x160	 SK06 114x118	 SK08 114x140	 SK10 114x160	 UK04 134x98	 UK08 134x140	 UK10 134x160
	-	-	-	-	-	-	-	-	-	-	-
	922,31 <b>1 116,00</b>	1 009,09 <b>1 221,00</b>	972,73 <b>1 177,00</b>	1 014,05 <b>1 227,00</b>	1 065,29 <b>1 289,00</b>	1 004,13 <b>1 215,00</b>	1 075,21 <b>1 301,00</b>	1 152,07 <b>1 394,00</b>	1 019,01 <b>1 233,00</b>	1 157,02 <b>1 400,00</b>	1 253,72 <b>1 517,00</b>
	987,60 <b>1 195,00</b>	1 085,12 <b>1 313,00</b>	1 044,63 <b>1 264,00</b>	1 090,91 <b>1 320,00</b>	1 147,93 <b>1 389,00</b>	1 079,34 <b>1 306,00</b>	1 158,68 <b>1 402,00</b>	1 244,63 <b>1 506,00</b>	1 095,87 <b>1 326,00</b>	1 250,41 <b>1 513,00</b>	1 359,50 <b>1 645,00</b>
	1 136,36 <b>1 375,00</b>	1 257,02 <b>1 521,00</b>	1 207,44 <b>1 461,00</b>	1 263,64 <b>1 529,00</b>	1 334,71 <b>1 615,00</b>	1 249,59 <b>1 512,00</b>	1 349,59 <b>1 633,00</b>	-	-	-	-
	922,31 <b>1 116,00</b>	-	972,73 <b>1 177,00</b>	-	1 065,29 <b>1 289,00</b>	1 004,13 <b>1 215,00</b>	1 075,21 <b>1 301,00</b>	-	1 019,01 <b>1 233,00</b>	1 157,02 <b>1 400,00</b>	-
	987,60 <b>1 195,00</b>	1 085,12 <b>1 313,00</b>	-	1 090,91 <b>1 320,00</b>	1 147,93 <b>1 389,00</b>	1 079,34 <b>1 306,00</b>	-	-	1 095,87 <b>1 326,00</b>	1 250,41 <b>1 513,00</b>	-
	1 058,68 <b>1 281,00</b>	1 166,94 <b>1 412,00</b>	1 122,31 <b>1 358,00</b>	1 173,55 <b>1 420,00</b>	1 237,19 <b>1 497,00</b>	1 160,33 <b>1 404,00</b>	1 249,59 <b>1 512,00</b>	1 345,45 <b>1 628,00</b>	1 180,17 <b>1 428,00</b>	1 352,07 <b>1 636,00</b>	1 473,55 <b>1 783,00</b>
	1 140,50 <b>1 380,00</b>	1 261,98 <b>1 527,00</b>	1 211,57 <b>1 466,00</b>	1 269,42 <b>1 536,00</b>	1 340,50 <b>1 622,00</b>	1 254,55 <b>1 518,00</b>	1 354,55 <b>1 639,00</b>	1 461,98 <b>1 769,00</b>	-	1 469,42 <b>1 778,00</b>	1 604,96 <b>1 942,00</b>
	1 326,45 <b>1 605,00</b>	1 476,86 <b>1 787,00</b>	1 414,88 <b>1 712,00</b>	1 485,95 <b>1 798,00</b>	1 575,21 <b>1 906,00</b>	1 468,60 <b>1 777,00</b>	1 592,56 <b>1 927,00</b>	-	-	-	-
	1 058,68 <b>1 281,00</b>	-	1 122,31 <b>1 358,00</b>	-	1 237,19 <b>1 497,00</b>	1 160,33 <b>1 404,00</b>	1 249,59 <b>1 512,00</b>	1 345,45 <b>1 628,00</b>	1 180,17 <b>1 428,00</b>	1 352,07 <b>1 636,00</b>	1 473,55 <b>1 783,00</b>
	1 140,50 <b>1 380,00</b>	1 261,98 <b>1 527,00</b>	1 211,57 <b>1 466,00</b>	1 269,42 <b>1 536,00</b>	1 340,50 <b>1 622,00</b>	1 254,55 <b>1 518,00</b>	-	1 461,98 <b>1 769,00</b>	1 276,03 <b>1 544,00</b>	1 469,42 <b>1 778,00</b>	1 604,96 <b>1 942,00</b>
	1 455,37 <b>1 761,00</b>	-	1 526,45 <b>1 847,00</b>	1 584,30 <b>1 917,00</b>	-	1 569,42 <b>1 899,00</b>	1 669,42 <b>2 020,00</b>	-	-	-	-

# JUMTA LŪKAS



Cenas bez PVN, Eiro  
Cenas ar PVN, Eiro

CK06  
55x118

FK06  
66x118

MK04  
78x98

## JUMTA LŪKAS

		W/(m <sup>2</sup> K)		Iebūvēšanas slīpums			
<b>GXL 3070</b>	Manuāla, priedes koks, apstrādāts ar trīskāršu pārklājumu, caurspīdīgs lakojums, vienkameras stikla pakete	1.3	15-85	-	499,17 <b>604,00</b>	488,43 <b>591,00</b>	
<b>GXL 3068</b>	Manuāla, priedes koks, apstrādāts ar trīskāršu pārklājumu, caurspīdīgs lakojums, divkameru stikla pakete	1.1	15-85	-	623,97 <b>755,00</b>	-	
<b>GXL 3066</b>	Manuāla, priedes koks, apstrādāts ar trīskāršu pārklājumu, caurspīdīgs lakojums, divkameru stikla pakete	1.0	15-85	-	698,35 <b>845,00</b>	-	
<b>GXU 0070</b>	Manuāla, balts poliuretāns ap koka kodolu ar papildu izturīgu pārklājumu, vienkameras stikla pakete	1.3	15-85	543,80 <b>658,00</b>	567,77 <b>687,00</b>	-	
<b>GXU 0066</b>	Manuāla, balts poliuretāns ap koka kodolu ar papildu izturīgu pārklājumu, divkameru stikla pakete	1.0	15-85	761,16 <b>921,00</b>	795,04 <b>962,00</b>	-	
<b>GXL 2070</b>	Manuāla, priedes koks, apstrādāts ar trīskāršu pārklājumu, balti krāsots, vienkameras stikla pakete	1.3	15-85	-	499,17 <b>604,00</b>	-	
<b>GXL 2066</b>	Manuāla, priedes koks, apstrādāts ar trīskāršu pārklājumu, balti krāsots, divkameru stikla pakete	1.0	15-85	-	698,35 <b>845,00</b>	-	

Pieslēgums jāiegādājas atsevišķi.

GXL/GXU jumta lūku var atvērt ar rokturi vērtnes vidū, vērtnes eņģu novietošanas puses var mainīt. GXL/GXU lūka atveras uz āru. Tā nav saderīga ar ārējiem aksesuāriem. Lai iegūtu papildinformāciju par GXL un GXU vara vai titāncinka uzlikām, lūdzu, sazinieties ar VELUX klientu servisu.



Cenas bez PVN, Eiro  
Cenas ar PVN, Eiro

MK08  
78x140

SK08  
114x140

## AVĀRIJAS IZEJA

		W/(m <sup>2</sup> K)		Iebūvēšanas slīpums			
<b>GTL 3070</b>	Verama ar roku pa augšējo asi, rokturis apakšā, priedes koks, apstrādāts ar trīskāršu pārklājumu, caurspīdīgs lakojums, vienkameras stikla pakete	1.3	15-55	703,31 <b>851,00</b>	900,83 <b>1 090,00</b>		
<b>GTL 3066</b>	Verama ar roku pa augšējo asi, rokturis apakšā, priedes koks, apstrādāts ar trīskāršu pārklājumu, caurspīdīgs lakojums, divkameru stikla pakete	1.0	15-55	984,30 <b>1 191,00</b>	1 260,33 <b>1 525,00</b>		
<b>GTU 0070</b>	Verama ar roku pa augšējo asi, rokturis apakšā, balts poliuretāns ap koka kodolu ar papildu izturīgu pārklājumu, vienkameras stikla pakete	1.3	15-55	799,17 <b>967,00</b>	1 023,97 <b>1 239,00</b>		
<b>GTU 0070</b>	Verama ar roku pa augšējo asi, rokturis apakšā, balts poliuretāns ap koka kodolu ar papildu izturīgu pārklājumu, vienkameras stikla pakete	1.3	15-40	-	-		
<b>GTU 0066</b>	Verama ar roku pa augšējo asi, rokturis apakšā, balts poliuretāns ap koka kodolu ar papildu izturīgu pārklājumu, divkameru stikla pakete	1.0	15-55	1 119,01 <b>1 354,00</b>	1 433,06 <b>1 734,00</b>		
<b>GTL 2070</b>	Verama ar roku pa augšējo asi, rokturis apakšā, priedes koks, apstrādāts ar trīskāršu pārklājumu, balti krāsots, vienkameras stikla pakete	1.3	15-55	703,31 <b>851,00</b>	900,83 <b>1 090,00</b>		
<b>GTL 2066</b>	Verama ar roku pa augšējo asi, rokturis apakšā, priedes koks, apstrādāts ar trīskāršu pārklājumu, balti krāsots, divkameru stikla pakete	1.0	15-55	984,30 <b>1 191,00</b>	1 260,33 <b>1 525,00</b>		

Pieslēgums jāiegādājas atsevišķi.

Cenas bez PVN, Euro  
Cenas ar PVN, Euro

Izmērs (cm)

+++  
46x61

024  
90x48

025  
45x55

029  
45x73

033  
85x85

034  
48x90

103  
54x83

## JUMTA LŪKAS NEAPKURINĀMIEM BĒNIŅIEM

Iebūvēšanas  
slīpums

<b>GVK 0000Z</b>	Verama no sāna, vienkameras stikla pakete. Iekšējā virsma: poliuretāns, melna laka. Ārējais materiāls: alumīnijs, tumši pelēks.	20-65	166,12 <b>201,00</b>	-	-	-	-	-	-
<b>VLT 1000</b>	Verama no sāna, vienkameras stikla pakete. Iekšējā virsma: priedes koks, apstrādāts ar dubultu pārklājumu, caurspīdīgs lakojums. Ārējais materiāls: alumīnijs, tumši pelēks	20-45	-	140,50 <b>170,00</b>	-	-	-	-	-
<b>VLT 1000</b>	Uz kreiso vai labo pusi verama vērtne, vienkameras stikla pakete. Iekšējā virsma: priedes koks, apstrādāts ar dubultu pārklājumu, caurspīdīgs lakojums. Ārējais materiāls: alumīnijs, tumši pelēks.	20-60	-	-	108,26 <b>131,00</b>	119,01 <b>144,00</b>	238,02 <b>288,00</b>	-	-
<b>VLT 1000</b>	Verama no sāna vai no Augšas, vienkameras stikla pakete. Iekšējā virsma: priedes koks, apstrādāts ar dubultu pārklājumu, caurspīdīgs lakojums. Ārējais materiāls: alumīnijs, tumši pelēks.	20-60	-	-	-	-	-	146,28 <b>177,00</b>	-
<b>GVT 0059Z</b>	Verama no sāna, vienkameras stikla Pakete. Iekšējā virsma: poliuretāns, melna laka. Ārējais materiāls: alumīnijs, tumši pelēks.	20-65	-	-	-	-	-	-	228,93 <b>277,00</b>
<b>GVT 7759Z</b>	Verama no sāna, vienkameras stikla Pakete. Iekšējā virsma: poliuretāns, sarkana laka. Ārējais materiāls: PUR, ķieģeļu sarkans.	20-65	-	-	-	-	-	-	247,11 <b>299,00</b>

# PIESLĒGUMI IEBŪVĒŠANAI SLĪPOS JUMTOS

Cenas bez PVN, Euro  
Cenas ar PVN, Euro

Izmērs (cm)

CK02  
55x78

CK04  
55x98

CK06  
55x118

FK04  
66x98

FK06  
66x118

FK08  
66x140

MK04  
78x98

MK06  
78x118

## VIENA LOGA IEBŪVĒŠANA

### Hidroizolācijas risinājums 1000 ietver difūzijas membrānu BFX un drenāžas noteku

Iebūvēšanas  
slīpums

#### Standarta iebūvēšanas līmenis (sarkanais līmenis)

Modelis	Apraksts	Izmērs (cm)	CK02	CK04	CK06	FK04	FK06	FK08	MK04	MK06
EDW 1000	Profilētiem jumta segumiem ar profila augstumu līdz 120 mm	15-90	104,13 <b>126,00</b>	106,61 <b>129,00</b>	110,74 <b>134,00</b>	110,74 <b>134,00</b>	119,83 <b>145,00</b>	125,62 <b>152,00</b>	119,83 <b>145,00</b>	125,62 <b>152,00</b>
EDT 1000	Plakaniem dakstiņiem 15-40 mm biezumā	20-90	104,13 <b>126,00</b>	106,61 <b>129,00</b>	110,74 <b>134,00</b>	110,74 <b>134,00</b>	119,83 <b>145,00</b>	125,62 <b>152,00</b>	119,83 <b>145,00</b>	125,62 <b>152,00</b>
EDS 1000	Plakaniem jumta segumiem ar augstumu līdz 16 mm (2 x 8 mm)	15-90	104,13 <b>126,00</b>	106,61 <b>129,00</b>	110,74 <b>134,00</b>	110,74 <b>134,00</b>	119,83 <b>145,00</b>	125,62 <b>152,00</b>	119,83 <b>145,00</b>	125,62 <b>152,00</b>
EDQ 1000L	Plakaniem metāla jumta segumiem ar click montāžas sistēmu un šuves augstumu no 25 līdz 35 mm	15-90	125,62 <b>152,00</b>	128,10 <b>155,00</b>	133,06 <b>161,00</b>	133,06 <b>161,00</b>	143,80 <b>174,00</b>	151,24 <b>183,00</b>	143,80 <b>174,00</b>	151,24 <b>183,00</b>
EDB 1000	Vienkāršu bebrastes dakstiņu jumtiem līdz 38 mm (2 x 19 mm)	25-90	104,13 <b>126,00</b>	106,61 <b>129,00</b>	110,74 <b>134,00</b>	110,74 <b>134,00</b>	119,83 <b>145,00</b>	125,62 <b>152,00</b>	119,83 <b>145,00</b>	125,62 <b>152,00</b>
EDL 1000	Jumta segumiem ar augstumu līdz 16 mm	15-90	104,13 <b>126,00</b>	106,61 <b>129,00</b>	110,74 <b>134,00</b>	110,74 <b>134,00</b>	119,83 <b>145,00</b>	125,62 <b>152,00</b>	119,83 <b>145,00</b>	125,62 <b>152,00</b>
EDP 1000	Vienkāršu dakstiņu jumtiem līdz 28 mm (2 x 14 mm)	25-90	104,13 <b>126,00</b>	106,61 <b>129,00</b>	110,74 <b>134,00</b>	110,74 <b>134,00</b>	119,83 <b>145,00</b>	125,62 <b>152,00</b>	119,83 <b>145,00</b>	125,62 <b>152,00</b>

#### Padziļināts iebūvēšanas līmenis 40 mm dziļāk jumta konstrukcijā (zilais līmenis)

EDJ 1000	Plakaniem vai profilētiem jumta segumiem ar augstumu līdz 90 mm	20-90	125,62 <b>152,00</b>	128,10 <b>155,00</b>	133,06 <b>161,00</b>	133,06 <b>161,00</b>	143,80 <b>174,00</b>	151,24 <b>183,00</b>	143,80 <b>174,00</b>	151,24 <b>183,00</b>
EDN 1000	Plakaniem jumta segumiem ar augstumu līdz 16 mm (2 x 8 mm)	20-90	125,62 <b>152,00</b>	128,10 <b>155,00</b>	133,06 <b>161,00</b>	133,06 <b>161,00</b>	143,80 <b>174,00</b>	151,24 <b>183,00</b>	143,80 <b>174,00</b>	151,24 <b>183,00</b>

Cenas bez PVN, Euro  
Cenas ar PVN, Euro

Izmērs (cm)

CK02  
55x78

CK04  
55x98

CK06  
55x118

FK04  
66x98

FK06  
66x118

FK08  
66x140

MK04  
78x98

MK06  
78x118

## HIDRO UN SILTUMIZOLĀCIJAS RISINĀJUMS 2000 IETVER DIFŪZIJAS MEMBRĀNU BFX, DRENĀŽAS NOTEKU UN SILTUMIZOLĀCIJAS RĀMI BDX













Iebūvēšanas  
slīpums













#### Standarta iebūvēšanas līmenis (sarkanais līmenis)

Modelis	Apraksts	Izmērs (cm)	CK02	CK04	CK06	FK04	FK06	FK08	MK04	MK06
EDW 2000	Profilētiem jumta segumiem ar profila augstumu līdz 120 mm	15-90	121,49 <b>147,00</b>	123,97 <b>150,00</b>	128,93 <b>156,00</b>	128,93 <b>156,00</b>	138,84 <b>168,00</b>	146,28 <b>177,00</b>	138,84 <b>168,00</b>	146,28 <b>177,00</b>
EDT 2000	Plakaniem dakstiņiem 15-40 mm biezumā	20-90	121,49 <b>147,00</b>	123,97 <b>150,00</b>	128,93 <b>156,00</b>	128,93 <b>156,00</b>	138,84 <b>168,00</b>	146,28 <b>177,00</b>	138,84 <b>168,00</b>	146,28 <b>177,00</b>
EDS 2000	Plakaniem jumta segumiem ar augstumu līdz 16 mm (2 x 8 mm)	15-90	121,49 <b>147,00</b>	123,97 <b>150,00</b>	128,93 <b>156,00</b>	128,93 <b>156,00</b>	138,84 <b>168,00</b>	146,28 <b>177,00</b>	138,84 <b>168,00</b>	146,28 <b>177,00</b>
EDQ 2000L	Plakaniem metāla jumta segumiem ar click montāžas sistēmu un šuves augstumu no 25 līdz 35 mm	15-90	145,45 <b>176,00</b>	149,59 <b>181,00</b>	154,55 <b>187,00</b>	154,55 <b>187,00</b>	166,94 <b>202,00</b>	175,21 <b>212,00</b>	166,94 <b>202,00</b>	175,21 <b>212,00</b>
EDB 2000	Vienkāršu bebrastes dakstiņu jumtiem līdz 38 mm (2 x 19 mm)	25-90	121,49 <b>147,00</b>	123,97 <b>150,00</b>	128,93 <b>156,00</b>	128,93 <b>156,00</b>	138,84 <b>168,00</b>	146,28 <b>177,00</b>	138,84 <b>168,00</b>	146,28 <b>177,00</b>
EDL 2000	Jumta segumiem ar augstumu līdz 16 mm	15-90	121,49 <b>147,00</b>	123,97 <b>150,00</b>	128,93 <b>156,00</b>	128,93 <b>156,00</b>	138,84 <b>168,00</b>	146,28 <b>177,00</b>	138,84 <b>168,00</b>	146,28 <b>177,00</b>

#### Padziļināts iebūvēšanas līmenis 40 mm dziļāk jumta konstrukcijā (zilais līmenis)

EDJ 2000	Plakaniem vai profilētiem jumta segumiem ar augstumu līdz 90 mm	20-90	145,45 <b>176,00</b>	149,59 <b>181,00</b>	154,55 <b>187,00</b>	154,55 <b>187,00</b>	166,94 <b>202,00</b>	175,21 <b>212,00</b>	166,94 <b>202,00</b>	175,21 <b>212,00</b>
EDN 2000	Plakaniem jumta segumiem ar augstumu līdz 16 mm (2 x 8 mm)	20-90	145,45 <b>176,00</b>	149,59 <b>181,00</b>	154,55 <b>187,00</b>	154,55 <b>187,00</b>	166,94 <b>202,00</b>	175,21 <b>212,00</b>	166,94 <b>202,00</b>	175,21 <b>212,00</b>

												
	133,06 <b>161,00</b>	147,11 <b>178,00</b>	149,59 <b>181,00</b>	142,15 <b>172,00</b>	149,59 <b>181,00</b>	154,55 <b>187,00</b>	148,76 <b>180,00</b>	157,02 <b>190,00</b>	163,64 <b>198,00</b>	157,02 <b>190,00</b>	169,42 <b>205,00</b>	188,43 <b>228,00</b>
	133,06 <b>161,00</b>	147,11 <b>178,00</b>	149,59 <b>181,00</b>	142,15 <b>172,00</b>	149,59 <b>181,00</b>	154,55 <b>187,00</b>	148,76 <b>180,00</b>	157,02 <b>190,00</b>	163,64 <b>198,00</b>	157,02 <b>190,00</b>	169,42 <b>205,00</b>	188,43 <b>228,00</b>
	133,06 <b>161,00</b>	147,11 <b>178,00</b>	149,59 <b>181,00</b>	142,15 <b>172,00</b>	149,59 <b>181,00</b>	154,55 <b>187,00</b>	148,76 <b>180,00</b>	157,02 <b>190,00</b>	163,64 <b>198,00</b>	157,02 <b>190,00</b>	169,42 <b>205,00</b>	188,43 <b>228,00</b>
	160,33 <b>194,00</b>	176,86 <b>214,00</b>	179,34 <b>217,00</b>	170,25 <b>206,00</b>	179,34 <b>217,00</b>	185,95 <b>225,00</b>	178,51 <b>216,00</b>	188,43 <b>228,00</b>	195,87 <b>237,00</b>	188,43 <b>228,00</b>	204,13 <b>247,00</b>	226,45 <b>274,00</b>
	133,06 <b>161,00</b>	147,11 <b>178,00</b>	149,59 <b>181,00</b>	142,15 <b>172,00</b>	149,59 <b>181,00</b>	154,55 <b>187,00</b>	148,76 <b>180,00</b>	157,02 <b>190,00</b>	163,64 <b>198,00</b>	157,02 <b>190,00</b>	169,42 <b>205,00</b>	188,43 <b>228,00</b>
	133,06 <b>161,00</b>	147,11 <b>178,00</b>	149,59 <b>181,00</b>	142,15 <b>172,00</b>	149,59 <b>181,00</b>	154,55 <b>187,00</b>	148,76 <b>180,00</b>	157,02 <b>190,00</b>	163,64 <b>198,00</b>	157,02 <b>190,00</b>	169,42 <b>205,00</b>	188,43 <b>228,00</b>
	133,06 <b>161,00</b>	147,11 <b>178,00</b>	-	142,15 <b>172,00</b>	149,59 <b>181,00</b>	154,55 <b>187,00</b>	148,76 <b>180,00</b>	157,02 <b>190,00</b>	163,64 <b>198,00</b>	157,02 <b>190,00</b>	169,42 <b>205,00</b>	188,43 <b>228,00</b>
	160,33 <b>194,00</b>	176,86 <b>214,00</b>	179,34 <b>217,00</b>	170,25 <b>206,00</b>	179,34 <b>217,00</b>	185,95 <b>225,00</b>	178,51 <b>216,00</b>	188,43 <b>228,00</b>	195,87 <b>237,00</b>	188,43 <b>228,00</b>	204,13 <b>247,00</b>	226,45 <b>274,00</b>
	160,33 <b>194,00</b>	176,86 <b>214,00</b>	179,34 <b>217,00</b>	170,25 <b>206,00</b>	179,34 <b>217,00</b>	185,95 <b>225,00</b>	178,51 <b>216,00</b>	188,43 <b>228,00</b>	195,87 <b>237,00</b>	188,43 <b>228,00</b>	204,13 <b>247,00</b>	226,45 <b>274,00</b>

												
	155,37 <b>188,00</b>	171,07 <b>207,00</b>	174,38 <b>211,00</b>	165,29 <b>200,00</b>	174,38 <b>211,00</b>	180,17 <b>218,00</b>	172,73 <b>209,00</b>	182,64 <b>221,00</b>	190,08 <b>230,00</b>	182,64 <b>221,00</b>	197,52 <b>239,00</b>	219,83 <b>266,00</b>
	155,37 <b>188,00</b>	171,07 <b>207,00</b>	174,38 <b>211,00</b>	165,29 <b>200,00</b>	174,38 <b>211,00</b>	180,17 <b>218,00</b>	172,73 <b>209,00</b>	182,64 <b>221,00</b>	190,08 <b>230,00</b>	182,64 <b>221,00</b>	197,52 <b>239,00</b>	219,83 <b>266,00</b>
	155,37 <b>188,00</b>	171,07 <b>207,00</b>	174,38 <b>211,00</b>	165,29 <b>200,00</b>	174,38 <b>211,00</b>	180,17 <b>218,00</b>	172,73 <b>209,00</b>	182,64 <b>221,00</b>	190,08 <b>230,00</b>	182,64 <b>221,00</b>	197,52 <b>239,00</b>	219,83 <b>266,00</b>
	185,95 <b>225,00</b>	205,79 <b>249,00</b>	209,09 <b>253,00</b>	198,35 <b>240,00</b>	209,09 <b>253,00</b>	215,70 <b>261,00</b>	207,44 <b>251,00</b>	219,83 <b>266,00</b>	228,10 <b>276,00</b>	219,83 <b>266,00</b>	237,19 <b>287,00</b>	263,64 <b>319,00</b>
	155,37 <b>188,00</b>	171,07 <b>207,00</b>	174,38 <b>211,00</b>	165,29 <b>200,00</b>	174,38 <b>211,00</b>	180,17 <b>218,00</b>	172,73 <b>209,00</b>	182,64 <b>221,00</b>	190,08 <b>230,00</b>	182,64 <b>221,00</b>	197,52 <b>239,00</b>	219,83 <b>266,00</b>
	155,37 <b>188,00</b>	171,07 <b>207,00</b>	174,38 <b>211,00</b>	165,29 <b>200,00</b>	174,38 <b>211,00</b>	180,17 <b>218,00</b>	172,73 <b>209,00</b>	182,64 <b>221,00</b>	190,08 <b>230,00</b>	182,64 <b>221,00</b>	197,52 <b>239,00</b>	219,83 <b>266,00</b>
	185,95 <b>225,00</b>	205,79 <b>249,00</b>	209,09 <b>253,00</b>	198,35 <b>240,00</b>	209,09 <b>253,00</b>	215,70 <b>261,00</b>	207,44 <b>251,00</b>	219,83 <b>266,00</b>	228,10 <b>276,00</b>	219,83 <b>266,00</b>	237,19 <b>287,00</b>	263,64 <b>319,00</b>
	185,95 <b>225,00</b>	205,79 <b>249,00</b>	209,09 <b>253,00</b>	198,35 <b>240,00</b>	209,09 <b>253,00</b>	215,70 <b>261,00</b>	207,44 <b>251,00</b>	219,83 <b>266,00</b>	228,10 <b>276,00</b>	219,83 <b>266,00</b>	237,19 <b>287,00</b>	263,64 <b>319,00</b>

Cenas bez PVN, Euro  
Cenas ar PVN, Euro

Izmērs (cm)

CK02  
55x78

CK04  
55x98

FK04  
66x98

FK06  
66x118

MK04  
78x98

MK06  
78x118

MK08  
78x140

MK10  
78x160

## LOGA NOMAIŅAS PIESLĒGUMS

### Pieslēgums bez BFX

Iebūvēšanas  
slīpums

			CK02	CK04	FK04	FK06	MK04	MK06	MK08	MK10
<b>EW 0000</b>	Profilētiem jumta segumiem ar profila augstumu līdz 120 mm	15-90	67,77 <b>82,00</b>	69,42 <b>84,00</b>	71,90 <b>87,00</b>	77,69 <b>94,00</b>	77,69 <b>94,00</b>	81,82 <b>99,00</b>	86,78 <b>105,00</b>	95,87 <b>116,00</b>
<b>EL 0000</b>	Jumta segumiem ar augstumu līdz 16 mm	15-90	67,77 <b>82,00</b>	69,42 <b>84,00</b>	71,90 <b>87,00</b>	77,69 <b>94,00</b>	77,69 <b>94,00</b>	81,82 <b>99,00</b>	86,78 <b>105,00</b>	95,87 <b>116,00</b>
<b>ELX 0000</b>	Visiem jumta segumiem	15-80	67,77 <b>82,00</b>	69,42 <b>84,00</b>	71,90 <b>87,00</b>	77,69 <b>94,00</b>	77,69 <b>94,00</b>	81,82 <b>99,00</b>	86,78 <b>105,00</b>	95,87 <b>116,00</b>

Šie nomainās pieslēgumi piemēroti vecākas paaudzes jumta logiem, kas ražoti līdz 2002. gadam.

Cenas bez PVN, Euro  
Cenas ar PVN, Euro

Izmērs (cm)

CK02  
55x78

CK04  
55x98

CK06  
55x118

FK04  
66x98

FK06  
66x118

MK04  
78x98

MK06  
78x118









MK08  
78x140











## LOGA NOMAIŅAS PIESLĒGUMI AR SILTUMIZOLĀCIJU UN BFX

Iebūvēšanas  
slīpums

			CK02	CK04	CK06	FK04	FK06	MK04	MK06	MK08
<b>EW 6000</b>	Profilētiem jumta segumiem ar profila augstumu līdz 120 mm	15-90	133,06 <b>161,00</b>	136,36 <b>165,00</b>	141,32 <b>171,00</b>	141,32 <b>171,00</b>	152,07 <b>184,00</b>	152,07 <b>184,00</b>	160,33 <b>194,00</b>	170,25 <b>206,00</b>
<b>EL 6000</b>	Jumta segumiem ar augstumu līdz 16 mm	15-90	133,06 <b>161,00</b>	136,36 <b>165,00</b>	141,32 <b>171,00</b>	141,32 <b>171,00</b>	152,07 <b>184,00</b>	152,07 <b>184,00</b>	160,33 <b>194,00</b>	170,25 <b>206,00</b>

Šie nomainās pieslēgumi piemēroti vecākas paaudzes jumta logiem, kas ražoti līdz 2002. gadam.

 PK06 94x118	 PK08 94x140	 PK10 94x160	 SK06 114x118	 SK08 114x140	 SK10 114x160	 UK04 134x98	 UK08 134x140	 UK10 134x160
92,56 <b>112,00</b>	97,52 <b>118,00</b>	100,83 <b>122,00</b>	96,69 <b>117,00</b>	102,48 <b>124,00</b>	106,61 <b>129,00</b>	102,48 <b>124,00</b>	110,74 <b>134,00</b>	123,14 <b>149,00</b>
92,56 <b>112,00</b>	97,52 <b>118,00</b>	100,83 <b>122,00</b>	96,69 <b>117,00</b>	102,48 <b>124,00</b>	106,61 <b>129,00</b>	102,48 <b>124,00</b>	110,74 <b>134,00</b>	123,14 <b>149,00</b>
92,56 <b>112,00</b>	97,52 <b>118,00</b>	100,83 <b>122,00</b>	96,69 <b>117,00</b>	102,48 <b>124,00</b>	106,61 <b>129,00</b>	102,48 <b>124,00</b>	110,74 <b>134,00</b>	123,14 <b>149,00</b>

 MK10 78x160	 PK06 94x118	 PK08 94x140	 PK10 94x160	 SK06 114x118	 SK08 114x140	 SK10 114x160	 UK04 134x98	 UK08 134x140	 UK10 134x160
187,60 <b>227,00</b>	180,99 <b>219,00</b>	190,91 <b>231,00</b>	197,52 <b>239,00</b>	189,26 <b>229,00</b>	200,00 <b>242,00</b>	208,26 <b>252,00</b>	200,00 <b>242,00</b>	216,53 <b>262,00</b>	240,50 <b>291,00</b>
187,60 <b>227,00</b>	180,99 <b>219,00</b>	190,91 <b>231,00</b>	197,52 <b>239,00</b>	189,26 <b>229,00</b>	200,00 <b>242,00</b>	208,26 <b>252,00</b>	200,00 <b>242,00</b>	216,53 <b>262,00</b>	240,50 <b>291,00</b>

Jaunums  
2024

Cenas bez PVN, Euro  
Cenas ar PVN, Euro

Izmērs (cm)

CK02  
55x78

CK04  
55x98

CK06  
55x118

FK04  
66x98

FK06  
66x118

FK08  
66x140

MK04  
78x98

MK06  
78x118

## KOMBINĒTO LOGU IEBŪVĒŠANA, PIELĀGOJAMA SAVIENOJOŠĀ DETALĀ

Iebūvēšanas  
slīpums

### Standarta iebūvēšanas līmenis (sarkanais līmenis)

<b>EKW 2001M</b>	Profilētiem jumta segumiem ar profila augstumu līdz 120 mm	15-90	121,49 <b>147,00</b>	123,97 <b>150,00</b>	128,93 <b>156,00</b>	128,93 <b>156,00</b>	138,84 <b>168,00</b>	146,28 <b>177,00</b>	138,84 <b>168,00</b>	146,28 <b>177,00</b>
<b>EKW 2002M</b>	Profilētiem jumta segumiem ar profila augstumu līdz 120 mm	15-90	121,49 <b>147,00</b>	123,97 <b>150,00</b>	128,93 <b>156,00</b>	128,93 <b>156,00</b>	138,84 <b>168,00</b>	146,28 <b>177,00</b>	138,84 <b>168,00</b>	146,28 <b>177,00</b>
<b>EKW 2003M</b>	Profilētiem jumta segumiem ar profila augstumu līdz 120 mm	15-90	121,49 <b>147,00</b>	123,97 <b>150,00</b>	128,93 <b>156,00</b>	128,93 <b>156,00</b>	138,84 <b>168,00</b>	146,28 <b>177,00</b>	138,84 <b>168,00</b>	146,28 <b>177,00</b>
<b>EKW 2004ME</b>	Profilētiem jumta segumiem ar profila augstumu līdz 120 mm	15-90	121,49 <b>147,00</b>	123,97 <b>150,00</b>	128,93 <b>156,00</b>	128,93 <b>156,00</b>	138,84 <b>168,00</b>	146,28 <b>177,00</b>	138,84 <b>168,00</b>	146,28 <b>177,00</b>
<b>EKW 2004MJ</b>	Profilētiem jumta segumiem ar profila augstumu līdz 120 mm	15-90	121,49 <b>147,00</b>	123,97 <b>150,00</b>	128,93 <b>156,00</b>	128,93 <b>156,00</b>	138,84 <b>168,00</b>	146,28 <b>177,00</b>	138,84 <b>168,00</b>	146,28 <b>177,00</b>
<b>EKW 2006ME</b>	Profilētiem jumta segumiem ar profila augstumu līdz 120 mm	15-90	121,49 <b>147,00</b>	123,97 <b>150,00</b>	128,93 <b>156,00</b>	128,93 <b>156,00</b>	138,84 <b>168,00</b>	146,28 <b>177,00</b>	138,84 <b>168,00</b>	146,28 <b>177,00</b>
<b>EKW 2006MJ</b>	Profilētiem jumta segumiem ar profila augstumu līdz 120 mm	15-90	121,49 <b>147,00</b>	123,97 <b>150,00</b>	128,93 <b>156,00</b>	128,93 <b>156,00</b>	138,84 <b>168,00</b>	146,28 <b>177,00</b>	138,84 <b>168,00</b>	146,28 <b>177,00</b>
<b>EKW 2007ME</b>	Profilētiem jumta segumiem ar profila augstumu līdz 120 mm	15-90	121,49 <b>147,00</b>	123,97 <b>150,00</b>	128,93 <b>156,00</b>	128,93 <b>156,00</b>	138,84 <b>168,00</b>	146,28 <b>177,00</b>	138,84 <b>168,00</b>	146,28 <b>177,00</b>
<b>EKW 2007MJ</b>	Profilētiem jumta segumiem ar profila augstumu līdz 120 mm	15-90	121,49 <b>147,00</b>	123,97 <b>150,00</b>	128,93 <b>156,00</b>	128,93 <b>156,00</b>	138,84 <b>168,00</b>	146,28 <b>177,00</b>	138,84 <b>168,00</b>	146,28 <b>177,00</b>
<b>EKW 2021M</b>	Profilētiem jumta segumiem ar profila augstumu līdz 120 mm	15-90	242,98 <b>294,00</b>	247,93 <b>300,00</b>	257,85 <b>312,00</b>	257,85 <b>312,00</b>	277,69 <b>336,00</b>	292,56 <b>354,00</b>	277,69 <b>336,00</b>	292,56 <b>354,00</b>
<b>EKS 2001M</b>	Plakaniem jumta segumiem ar augstumu līdz 16 mm (2 x 8 mm)	15-90	121,49 <b>147,00</b>	123,97 <b>150,00</b>	128,93 <b>156,00</b>	128,93 <b>156,00</b>	138,84 <b>168,00</b>	146,28 <b>177,00</b>	138,84 <b>168,00</b>	146,28 <b>177,00</b>
<b>EKS 2002M</b>	Plakaniem jumta segumiem ar augstumu līdz 16 mm (2 x 8 mm)	15-90	121,49 <b>147,00</b>	123,97 <b>150,00</b>	128,93 <b>156,00</b>	128,93 <b>156,00</b>	138,84 <b>168,00</b>	146,28 <b>177,00</b>	138,84 <b>168,00</b>	146,28 <b>177,00</b>
<b>EKS 2003M</b>	Plakaniem jumta segumiem ar augstumu līdz 16 mm (2 x 8 mm)	15-90	121,49 <b>147,00</b>	123,97 <b>150,00</b>	128,93 <b>156,00</b>	128,93 <b>156,00</b>	138,84 <b>168,00</b>	146,28 <b>177,00</b>	138,84 <b>168,00</b>	146,28 <b>177,00</b>
<b>EKS 2004ME</b>	Plakaniem jumta segumiem ar augstumu līdz 16 mm (2 x 8 mm)	15-90	121,49 <b>147,00</b>	123,97 <b>150,00</b>	128,93 <b>156,00</b>	128,93 <b>156,00</b>	138,84 <b>168,00</b>	146,28 <b>177,00</b>	138,84 <b>168,00</b>	146,28 <b>177,00</b>
<b>EKS 2004MJ</b>	Plakaniem jumta segumiem ar augstumu līdz 16 mm (2 x 8 mm)	15-90	121,49 <b>147,00</b>	123,97 <b>150,00</b>	128,93 <b>156,00</b>	128,93 <b>156,00</b>	138,84 <b>168,00</b>	146,28 <b>177,00</b>	138,84 <b>168,00</b>	146,28 <b>177,00</b>
<b>EKS 2006ME</b>	Plakaniem jumta segumiem ar augstumu līdz 16 mm (2 x 8 mm)	15-90	121,49 <b>147,00</b>	123,97 <b>150,00</b>	128,93 <b>156,00</b>	128,93 <b>156,00</b>	138,84 <b>168,00</b>	146,28 <b>177,00</b>	138,84 <b>168,00</b>	146,28 <b>177,00</b>
<b>EKS 2006MJ</b>	Plakaniem jumta segumiem ar augstumu līdz 16 mm (2 x 8 mm)	15-90	121,49 <b>147,00</b>	123,97 <b>150,00</b>	128,93 <b>156,00</b>	128,93 <b>156,00</b>	138,84 <b>168,00</b>	146,28 <b>177,00</b>	138,84 <b>168,00</b>	146,28 <b>177,00</b>
<b>EKS 2007ME</b>	Plakaniem jumta segumiem ar augstumu līdz 16 mm (2 x 8 mm)	15-90	121,49 <b>147,00</b>	123,97 <b>150,00</b>	128,93 <b>156,00</b>	128,93 <b>156,00</b>	138,84 <b>168,00</b>	146,28 <b>177,00</b>	138,84 <b>168,00</b>	146,28 <b>177,00</b>
<b>EKS 2007MJ</b>	Plakaniem jumta segumiem ar augstumu līdz 16 mm (2 x 8 mm)	15-90	121,49 <b>147,00</b>	123,97 <b>150,00</b>	128,93 <b>156,00</b>	128,93 <b>156,00</b>	138,84 <b>168,00</b>	146,28 <b>177,00</b>	138,84 <b>168,00</b>	146,28 <b>177,00</b>
<b>EKS 2021M</b>	Plakaniem jumta segumiem ar augstumu līdz 16 mm (2 x 8 mm)	15-90	242,98 <b>294,00</b>	247,93 <b>300,00</b>	257,85 <b>312,00</b>	257,85 <b>312,00</b>	277,69 <b>336,00</b>	292,56 <b>354,00</b>	277,69 <b>336,00</b>	292,56 <b>354,00</b>
<b>EKQ 2001M</b>	Plakaniem metāla jumta segumiem ar click montāžas sistēmu un šuves augstumu no 25 līdz 35 mm	15-90	121,49 <b>147,00</b>	123,97 <b>150,00</b>	128,93 <b>156,00</b>	128,93 <b>156,00</b>	138,84 <b>168,00</b>	146,28 <b>177,00</b>	138,84 <b>168,00</b>	146,28 <b>177,00</b>
<b>EKQ 2002M</b>	Plakaniem metāla jumta segumiem ar click montāžas sistēmu un šuves augstumu no 25 līdz 35 mm	15-90	121,49 <b>147,00</b>	123,97 <b>150,00</b>	128,93 <b>156,00</b>	128,93 <b>156,00</b>	138,84 <b>168,00</b>	146,28 <b>177,00</b>	138,84 <b>168,00</b>	146,28 <b>177,00</b>
<b>EKQ 2003M</b>	Plakaniem metāla jumta segumiem ar click montāžas sistēmu un šuves augstumu no 25 līdz 35 mm	15-90	121,49 <b>147,00</b>	123,97 <b>150,00</b>	128,93 <b>156,00</b>	128,93 <b>156,00</b>	138,84 <b>168,00</b>	146,28 <b>177,00</b>	138,84 <b>168,00</b>	146,28 <b>177,00</b>
<b>EKQ 2004ME</b>	Plakaniem metāla jumta segumiem ar click montāžas sistēmu un šuves augstumu no 25 līdz 35 mm	15-90	121,49 <b>147,00</b>	123,97 <b>150,00</b>	128,93 <b>156,00</b>	128,93 <b>156,00</b>	138,84 <b>168,00</b>	146,28 <b>177,00</b>	138,84 <b>168,00</b>	146,28 <b>177,00</b>
<b>EKQ 2004MJ</b>	Plakaniem metāla jumta segumiem ar click montāžas sistēmu un šuves augstumu no 25 līdz 35 mm	15-90	121,49 <b>147,00</b>	123,97 <b>150,00</b>	128,93 <b>156,00</b>	128,93 <b>156,00</b>	138,84 <b>168,00</b>	146,28 <b>177,00</b>	138,84 <b>168,00</b>	146,28 <b>177,00</b>
<b>EKQ 2006ME</b>	Plakaniem metāla jumta segumiem ar click montāžas sistēmu un šuves augstumu no 25 līdz 35 mm	15-90	121,49 <b>147,00</b>	123,97 <b>150,00</b>	128,93 <b>156,00</b>	128,93 <b>156,00</b>	138,84 <b>168,00</b>	146,28 <b>177,00</b>	138,84 <b>168,00</b>	146,28 <b>177,00</b>
<b>EKQ 2006MJ</b>	Plakaniem metāla jumta segumiem ar click montāžas sistēmu un šuves augstumu no 25 līdz 35 mm	15-90	121,49 <b>147,00</b>	123,97 <b>150,00</b>	128,93 <b>156,00</b>	128,93 <b>156,00</b>	138,84 <b>168,00</b>	146,28 <b>177,00</b>	138,84 <b>168,00</b>	146,28 <b>177,00</b>





Cenas bez PVN, Euro  
Cenas ar PVN, Euro

Izmērs (cm)

CK02  
55x78

CK04  
55x98

CK06  
55x118

FK04  
66x98

FK06  
66x118

FK08  
66x140

MK04  
78x98













MK06  
78x118

## KOMBINĒTO LOGU IEBŪVĒŠANA, PIELĀGOJAMA SAVIENOJOŠĀ DETALĀ

Iebūvēšanas  
slīpums

### Standarta iebūvēšanas līmenis (sarkanais līmenis)

			CK02 55x78	CK04 55x98	CK06 55x118	FK04 66x98	FK06 66x118	FK08 66x140	MK04 78x98	MK06 78x118	
<b>EKQ 2007ME</b>	Plakaniem metāla jumta segumiem ar click montāžas sistēmu un šuves augstumu no 25 līdz 35 mm	15-90	121,49 <b>147,00</b>	123,97 <b>150,00</b>	128,93 <b>156,00</b>	128,93 <b>156,00</b>	138,84 <b>168,00</b>	146,28 <b>177,00</b>	138,84 <b>168,00</b>	146,28 <b>177,00</b>	
<b>EKQ 2007MJ</b>	Plakaniem metāla jumta segumiem ar click montāžas sistēmu un šuves augstumu no 25 līdz 35 mm	15-90	121,49 <b>147,00</b>	123,97 <b>150,00</b>	128,93 <b>156,00</b>	128,93 <b>156,00</b>	138,84 <b>168,00</b>	146,28 <b>177,00</b>	138,84 <b>168,00</b>	146,28 <b>177,00</b>	
<b>EKL 2001M</b>	Jumta segumiem ar augstumu līdz 16 mm	15-90	121,49 <b>147,00</b>	123,97 <b>150,00</b>	128,93 <b>156,00</b>	128,93 <b>156,00</b>	138,84 <b>168,00</b>	146,28 <b>177,00</b>	138,84 <b>168,00</b>	146,28 <b>177,00</b>	
<b>EKL 2002M</b>	Jumta segumiem ar augstumu līdz 16 mm	15-90	121,49 <b>147,00</b>	123,97 <b>150,00</b>	128,93 <b>156,00</b>	128,93 <b>156,00</b>	138,84 <b>168,00</b>	146,28 <b>177,00</b>	138,84 <b>168,00</b>	146,28 <b>177,00</b>	
<b>EKL 2003M</b>	Jumta segumiem ar augstumu līdz 16 mm	15-90	121,49 <b>147,00</b>	123,97 <b>150,00</b>	128,93 <b>156,00</b>	128,93 <b>156,00</b>	138,84 <b>168,00</b>	146,28 <b>177,00</b>	138,84 <b>168,00</b>	146,28 <b>177,00</b>	
<b>EKL 2004ME</b>	Jumta segumiem ar augstumu līdz 16 mm	15-90	121,49 <b>147,00</b>	123,97 <b>150,00</b>	128,93 <b>156,00</b>	128,93 <b>156,00</b>	138,84 <b>168,00</b>	146,28 <b>177,00</b>	138,84 <b>168,00</b>	146,28 <b>177,00</b>	
<b>EKL 2004MJ</b>	Jumta segumiem ar augstumu līdz 16 mm	15-90	121,49 <b>147,00</b>	123,97 <b>150,00</b>	128,93 <b>156,00</b>	128,93 <b>156,00</b>	138,84 <b>168,00</b>	146,28 <b>177,00</b>	138,84 <b>168,00</b>	146,28 <b>177,00</b>	
<b>EKL 2006ME</b>	Jumta segumiem ar augstumu līdz 16 mm	15-90	121,49 <b>147,00</b>	123,97 <b>150,00</b>	128,93 <b>156,00</b>	128,93 <b>156,00</b>	138,84 <b>168,00</b>	146,28 <b>177,00</b>	138,84 <b>168,00</b>	146,28 <b>177,00</b>	
<b>EKL 2006MJ</b>	Jumta segumiem ar augstumu līdz 16 mm	15-90	121,49 <b>147,00</b>	123,97 <b>150,00</b>	128,93 <b>156,00</b>	128,93 <b>156,00</b>	138,84 <b>168,00</b>	146,28 <b>177,00</b>	138,84 <b>168,00</b>	146,28 <b>177,00</b>	
<b>EKL 2007ME</b>	Jumta segumiem ar augstumu līdz 16 mm	15-90	121,49 <b>147,00</b>	123,97 <b>150,00</b>	128,93 <b>156,00</b>	128,93 <b>156,00</b>	138,84 <b>168,00</b>	146,28 <b>177,00</b>	138,84 <b>168,00</b>	146,28 <b>177,00</b>	
<b>EKL 2007MJ</b>	Jumta segumiem ar augstumu līdz 16 mm	15-90	121,49 <b>147,00</b>	123,97 <b>150,00</b>	128,93 <b>156,00</b>	128,93 <b>156,00</b>	138,84 <b>168,00</b>	146,28 <b>177,00</b>	138,84 <b>168,00</b>	146,28 <b>177,00</b>	
<b>EKL 2021M</b>	Jumta segumiem ar augstumu līdz 16 mm	15-90	242,98 <b>294,00</b>	247,93 <b>300,00</b>	257,85 <b>312,00</b>	257,85 <b>312,00</b>	277,69 <b>336,00</b>	292,56 <b>354,00</b>	277,69 <b>336,00</b>	292,56 <b>354,00</b>	

	 MK08 78x140	 MK10 78x160	 MK12 78x180	 PK06 94x118	 PK08 94x140	 PK10 94x160	 SK06 114x118	 SK08 114x140	 SK10 114x160	 UK04 134x98	 UK08 134x140	 UK10 134x160
	155,37 <b>188,00</b>	171,07 <b>207,00</b>	174,38 <b>211,00</b>	165,29 <b>200,00</b>	174,38 <b>211,00</b>	180,17 <b>218,00</b>	172,73 <b>209,00</b>	182,64 <b>221,00</b>	190,08 <b>230,00</b>	182,64 <b>221,00</b>	197,52 <b>239,00</b>	219,83 <b>266,00</b>
	155,37 <b>188,00</b>	171,07 <b>207,00</b>	174,38 <b>211,00</b>	165,29 <b>200,00</b>	174,38 <b>211,00</b>	180,17 <b>218,00</b>	172,73 <b>209,00</b>	182,64 <b>221,00</b>	190,08 <b>230,00</b>	182,64 <b>221,00</b>	197,52 <b>239,00</b>	219,83 <b>266,00</b>
	155,37 <b>188,00</b>	171,07 <b>207,00</b>	174,38 <b>211,00</b>	165,29 <b>200,00</b>	174,38 <b>211,00</b>	180,17 <b>218,00</b>	172,73 <b>209,00</b>	182,64 <b>221,00</b>	190,08 <b>230,00</b>	182,64 <b>221,00</b>	197,52 <b>239,00</b>	219,83 <b>266,00</b>
	155,37 <b>188,00</b>	171,07 <b>207,00</b>	174,38 <b>211,00</b>	165,29 <b>200,00</b>	174,38 <b>211,00</b>	180,17 <b>218,00</b>	172,73 <b>209,00</b>	182,64 <b>221,00</b>	190,08 <b>230,00</b>	182,64 <b>221,00</b>	197,52 <b>239,00</b>	219,83 <b>266,00</b>
	155,37 <b>188,00</b>	171,07 <b>207,00</b>	174,38 <b>211,00</b>	165,29 <b>200,00</b>	174,38 <b>211,00</b>	180,17 <b>218,00</b>	172,73 <b>209,00</b>	182,64 <b>221,00</b>	190,08 <b>230,00</b>	182,64 <b>221,00</b>	197,52 <b>239,00</b>	219,83 <b>266,00</b>
	155,37 <b>188,00</b>	171,07 <b>207,00</b>	174,38 <b>211,00</b>	165,29 <b>200,00</b>	174,38 <b>211,00</b>	180,17 <b>218,00</b>	172,73 <b>209,00</b>	182,64 <b>221,00</b>	190,08 <b>230,00</b>	182,64 <b>221,00</b>	197,52 <b>239,00</b>	219,83 <b>266,00</b>
	155,37 <b>188,00</b>	171,07 <b>207,00</b>	-	165,29 <b>200,00</b>	174,38 <b>211,00</b>	180,17 <b>218,00</b>	172,73 <b>209,00</b>	182,64 <b>221,00</b>	190,08 <b>230,00</b>	182,64 <b>221,00</b>	197,52 <b>239,00</b>	219,83 <b>266,00</b>
	155,37 <b>188,00</b>	171,07 <b>207,00</b>	174,38 <b>211,00</b>	165,29 <b>200,00</b>	174,38 <b>211,00</b>	180,17 <b>218,00</b>	172,73 <b>209,00</b>	182,64 <b>221,00</b>	190,08 <b>230,00</b>	182,64 <b>221,00</b>	197,52 <b>239,00</b>	219,83 <b>266,00</b>
	155,37 <b>188,00</b>	171,07 <b>207,00</b>	-	165,29 <b>200,00</b>	174,38 <b>211,00</b>	180,17 <b>218,00</b>	172,73 <b>209,00</b>	182,64 <b>221,00</b>	190,08 <b>230,00</b>	182,64 <b>221,00</b>	197,52 <b>239,00</b>	219,83 <b>266,00</b>
	155,37 <b>188,00</b>	171,07 <b>207,00</b>	174,38 <b>211,00</b>	165,29 <b>200,00</b>	174,38 <b>211,00</b>	180,17 <b>218,00</b>	172,73 <b>209,00</b>	182,64 <b>221,00</b>	190,08 <b>230,00</b>	182,64 <b>221,00</b>	197,52 <b>239,00</b>	219,83 <b>266,00</b>
	155,37 <b>188,00</b>	171,07 <b>207,00</b>	-	165,29 <b>200,00</b>	174,38 <b>211,00</b>	180,17 <b>218,00</b>	172,73 <b>209,00</b>	182,64 <b>221,00</b>	190,08 <b>230,00</b>	182,64 <b>221,00</b>	197,52 <b>239,00</b>	219,83 <b>266,00</b>
	310,74 <b>376,00</b>	342,15 <b>414,00</b>	348,76 <b>422,00</b>	330,58 <b>400,00</b>	348,76 <b>422,00</b>	360,33 <b>436,00</b>	345,45 <b>418,00</b>	365,29 <b>442,00</b>	380,17 <b>460,00</b>	365,29 <b>442,00</b>	395,04 <b>478,00</b>	439,67 <b>532,00</b>

Cenas bez PVN, Euro  
Cenas ar PVN, Euro

Izmērs (cm)

CK02  
55x78

CK04  
55x98

CK06  
55x118

FK04  
66x98

FK06  
66x118

FK08  
66x140

MK04  
78x98

MK06  
78x118

## KOMBINĒTĀ IEBŪVĒŠANA

### Horizontālas un vertikālas kombinācijas

Iebūvēšanas  
slīpums

#### Standarta iebūvēšanas līmenis (sarkanais līmenis)













EKT 0001E (F, G, H)*	Plakaniem dakstiņiem 15–40 mm biezumā	20–90	85,12 <b>103,00</b>	86,78 <b>105,00</b>	90,08 <b>109,00</b>	90,08 <b>109,00</b>	97,52 <b>118,00</b>	102,48 <b>124,00</b>	97,52 <b>118,00</b>	102,48 <b>124,00</b>
EKT 0002E (F, G, H)*	Plakaniem dakstiņiem 15–40 mm biezumā	20–90	85,12 <b>103,00</b>	86,78 <b>105,00</b>	90,08 <b>109,00</b>	90,08 <b>109,00</b>	97,52 <b>118,00</b>	102,48 <b>124,00</b>	97,52 <b>118,00</b>	102,48 <b>124,00</b>
EKT 0003	Plakaniem dakstiņiem 15–40 mm biezumā	20–90	85,12 <b>103,00</b>	86,78 <b>105,00</b>	90,08 <b>109,00</b>	90,08 <b>109,00</b>	97,52 <b>118,00</b>	102,48 <b>124,00</b>	97,52 <b>118,00</b>	102,48 <b>124,00</b>
EKB 0003	Vienkāršu bebrastes dakstiņu jumtiem līdz 38 mm (2 x 19 mm)	25–90	85,12 <b>103,00</b>	86,78 <b>105,00</b>	90,08 <b>109,00</b>	90,08 <b>109,00</b>	97,52 <b>118,00</b>	102,48 <b>124,00</b>	97,52 <b>118,00</b>	102,48 <b>124,00</b>
EKB 0004EE (EJ, FE, FJ, GE, GJ, HE, HJ)**	Vienkāršu bebrastes dakstiņu jumtiem līdz 38 mm (2 x 19 mm)	25–90	85,12 <b>103,00</b>	86,78 <b>105,00</b>	90,08 <b>109,00</b>	90,08 <b>109,00</b>	97,52 <b>118,00</b>	102,48 <b>124,00</b>	97,52 <b>118,00</b>	102,48 <b>124,00</b>
EKB 0006E (J)	Vienkāršu bebrastes dakstiņu jumtiem līdz 38 mm (2 x 19 mm)	25–90	85,12 <b>103,00</b>	86,78 <b>105,00</b>	90,08 <b>109,00</b>	90,08 <b>109,00</b>	97,52 <b>118,00</b>	102,48 <b>124,00</b>	97,52 <b>118,00</b>	102,48 <b>124,00</b>
EKB 0007E (J)	Vienkāršu bebrastes dakstiņu jumtiem līdz 38 mm (2 x 19 mm)	25–90	85,12 <b>103,00</b>	86,78 <b>105,00</b>	90,08 <b>109,00</b>	90,08 <b>109,00</b>	97,52 <b>118,00</b>	102,48 <b>124,00</b>	97,52 <b>118,00</b>	102,48 <b>124,00</b>
EKP 0002E (F, G, H)*	Vienkāršu dakstiņu jumtiem līdz 28 mm (2 x 14 mm)	25–90	85,12 <b>103,00</b>	86,78 <b>105,00</b>	90,08 <b>109,00</b>	–	97,52 <b>118,00</b>	–	97,52 <b>118,00</b>	102,48 <b>124,00</b>
EKP 0021E (F, G, H)*	Vienkāršu dakstiņu jumtiem līdz 28 mm (2 x 14 mm)	25–90	170,25 <b>206,00</b>	173,55 <b>210,00</b>	180,17 <b>218,00</b>	–	195,04 <b>236,00</b>	–	195,04 <b>236,00</b>	204,96 <b>248,00</b>

#### Padziļināts iebūvēšanas līmenis 40 mm dziļāk jumta konstrukcijā (zilais līmenis)

EKJ 0001E (F, G, H)*	Plakaniem vai profilētiem jumta segumiem ar augstumu līdz 90 mm	20–90	101,65 <b>123,00</b>	104,13 <b>126,00</b>	108,26 <b>131,00</b>	108,26 <b>131,00</b>	116,53 <b>141,00</b>	123,14 <b>149,00</b>	116,53 <b>141,00</b>	123,14 <b>149,00</b>
EKJ 0002E (F, G, H)*	Plakaniem vai profilētiem jumta segumiem ar augstumu līdz 90 mm	20–90	101,65 <b>123,00</b>	104,13 <b>126,00</b>	108,26 <b>131,00</b>	108,26 <b>131,00</b>	116,53 <b>141,00</b>	123,14 <b>149,00</b>	116,53 <b>141,00</b>	123,14 <b>149,00</b>
EKJ 0003	Plakaniem vai profilētiem jumta segumiem ar augstumu līdz 90 mm	20–90	101,65 <b>123,00</b>	104,13 <b>126,00</b>	108,26 <b>131,00</b>	108,26 <b>131,00</b>	116,53 <b>141,00</b>	123,14 <b>149,00</b>	116,53 <b>141,00</b>	123,14 <b>149,00</b>
EKJ 0004EE (EJ, FE, FJ, GE, GJ, HE, HJ)**	Plakaniem vai profilētiem jumta segumiem ar augstumu līdz 90 mm	20–90	101,65 <b>123,00</b>	104,13 <b>126,00</b>	108,26 <b>131,00</b>	108,26 <b>131,00</b>	116,53 <b>141,00</b>	123,14 <b>149,00</b>	116,53 <b>141,00</b>	123,14 <b>149,00</b>
EKJ 0006E (J)	Plakaniem vai profilētiem jumta segumiem ar augstumu līdz 90 mm	20–90	101,65 <b>123,00</b>	104,13 <b>126,00</b>	108,26 <b>131,00</b>	108,26 <b>131,00</b>	116,53 <b>141,00</b>	123,14 <b>149,00</b>	116,53 <b>141,00</b>	123,14 <b>149,00</b>
EKJ 0007E (J)	Plakaniem vai profilētiem jumta segumiem ar augstumu līdz 90 mm	20–90	101,65 <b>123,00</b>	104,13 <b>126,00</b>	108,26 <b>131,00</b>	108,26 <b>131,00</b>	116,53 <b>141,00</b>	123,14 <b>149,00</b>	116,53 <b>141,00</b>	123,14 <b>149,00</b>
EKN 0001E (F, G, H)*	Plakaniem jumta segumiem ar augstumu līdz 16 mm (2 x 8 mm)	20–90	101,65 <b>123,00</b>	104,13 <b>126,00</b>	108,26 <b>131,00</b>	108,26 <b>131,00</b>	116,53 <b>141,00</b>	123,14 <b>149,00</b>	116,53 <b>141,00</b>	123,14 <b>149,00</b>
EKN 0002E (F, G, H)*	Plakaniem jumta segumiem ar augstumu līdz 16 mm (2 x 8 mm)	20–90	101,65 <b>123,00</b>	104,13 <b>126,00</b>	108,26 <b>131,00</b>	108,26 <b>131,00</b>	116,53 <b>141,00</b>	123,14 <b>149,00</b>	116,53 <b>141,00</b>	123,14 <b>149,00</b>
EKN 0003	Plakaniem jumta segumiem ar augstumu līdz 16 mm (2 x 8 mm)	20–90	101,65 <b>123,00</b>	104,13 <b>126,00</b>	108,26 <b>131,00</b>	108,26 <b>131,00</b>	116,53 <b>141,00</b>	123,14 <b>149,00</b>	116,53 <b>141,00</b>	123,14 <b>149,00</b>
EKN 0004EE (EJ, FE, FJ, GE, GJ, HE, HJ)**	Plakaniem jumta segumiem ar augstumu līdz 16 mm (2 x 8 mm)	20–90	101,65 <b>123,00</b>	104,13 <b>126,00</b>	108,26 <b>131,00</b>	108,26 <b>131,00</b>	116,53 <b>141,00</b>	123,14 <b>149,00</b>	116,53 <b>141,00</b>	123,14 <b>149,00</b>
EKN 0006E (J)	Plakaniem jumta segumiem ar augstumu līdz 16 mm (2 x 8 mm)	20–90	101,65 <b>123,00</b>	104,13 <b>126,00</b>	108,26 <b>131,00</b>	108,26 <b>131,00</b>	116,53 <b>141,00</b>	123,14 <b>149,00</b>	116,53 <b>141,00</b>	123,14 <b>149,00</b>
EKN 0007E (J)	Plakaniem jumta segumiem ar augstumu līdz 16 mm (2 x 8 mm)	20–90	101,65 <b>123,00</b>	104,13 <b>126,00</b>	108,26 <b>131,00</b>	108,26 <b>131,00</b>	116,53 <b>141,00</b>	123,14 <b>149,00</b>	116,53 <b>141,00</b>	123,14 <b>149,00</b>

\* E = rāmju attālums 100 mm, F = rāmju attālums 120 mm, G = rāmju attālums 140 mm, H = rāmju attālums 160 mm

\*\* Rāmju attālums mm (horizontāli/vertikāli): EE – 100/100, EJ – 100/250, FE – 120/100, FJ – 120/250, GE – 140/100, GJ – 140/250, HE – 160/100, HJ – 160/250

												
	MK08 78x140	MK10 78x160	MK12 78x180	PK06 94x118	PK08 94x140	PK10 94x160	SK06 114x118	SK08 114x140	SK10 114x160	UK04 134x98	UK08 134x140	UK10 134x160
	108,26 <b>131,00</b>	119,83 <b>145,00</b>	121,49 <b>147,00</b>	115,70 <b>140,00</b>	121,49 <b>147,00</b>	125,62 <b>152,00</b>	120,66 <b>146,00</b>	128,10 <b>155,00</b>	133,06 <b>161,00</b>	128,10 <b>155,00</b>	138,02 <b>167,00</b>	153,72 <b>186,00</b>
	108,26 <b>131,00</b>	119,83 <b>145,00</b>	121,49 <b>147,00</b>	115,70 <b>140,00</b>	121,49 <b>147,00</b>	125,62 <b>152,00</b>	120,66 <b>146,00</b>	128,10 <b>155,00</b>	133,06 <b>161,00</b>	128,10 <b>155,00</b>	138,02 <b>167,00</b>	153,72 <b>186,00</b>
	108,26 <b>131,00</b>	119,83 <b>145,00</b>	121,49 <b>147,00</b>	115,70 <b>140,00</b>	121,49 <b>147,00</b>	125,62 <b>152,00</b>	120,66 <b>146,00</b>	128,10 <b>155,00</b>	133,06 <b>161,00</b>	128,10 <b>155,00</b>	138,02 <b>167,00</b>	153,72 <b>186,00</b>
	108,26 <b>131,00</b>	119,83 <b>145,00</b>	-	115,70 <b>140,00</b>	121,49 <b>147,00</b>	125,62 <b>152,00</b>	120,66 <b>146,00</b>	128,10 <b>155,00</b>	133,06 <b>161,00</b>	128,10 <b>155,00</b>	138,02 <b>167,00</b>	153,72 <b>186,00</b>
	108,26 <b>131,00</b>	119,83 <b>145,00</b>	-	115,70 <b>140,00</b>	121,49 <b>147,00</b>	125,62 <b>152,00</b>	120,66 <b>146,00</b>	128,10 <b>155,00</b>	133,06 <b>161,00</b>	128,10 <b>155,00</b>	138,02 <b>167,00</b>	153,72 <b>186,00</b>
	108,26 <b>131,00</b>	119,83 <b>145,00</b>	-	115,70 <b>140,00</b>	121,49 <b>147,00</b>	125,62 <b>152,00</b>	120,66 <b>146,00</b>	128,10 <b>155,00</b>	133,06 <b>161,00</b>	128,10 <b>155,00</b>	138,02 <b>167,00</b>	153,72 <b>186,00</b>
	108,26 <b>131,00</b>	119,83 <b>145,00</b>	-	115,70 <b>140,00</b>	121,49 <b>147,00</b>	125,62 <b>152,00</b>	120,66 <b>146,00</b>	128,10 <b>155,00</b>	133,06 <b>161,00</b>	128,10 <b>155,00</b>	138,02 <b>167,00</b>	153,72 <b>186,00</b>
	108,26 <b>131,00</b>	-	-	-	121,49 <b>147,00</b>	125,62 <b>152,00</b>	120,66 <b>146,00</b>	-	-	128,10 <b>155,00</b>	138,02 <b>167,00</b>	-
	216,53 <b>262,00</b>	-	-	-	242,98 <b>294,00</b>	251,24 <b>304,00</b>	241,32 <b>292,00</b>	-	-	256,20 <b>310,00</b>	276,03 <b>334,00</b>	-
	130,58 <b>158,00</b>	143,80 <b>174,00</b>	146,28 <b>177,00</b>	138,84 <b>168,00</b>	146,28 <b>177,00</b>	151,24 <b>183,00</b>	144,63 <b>175,00</b>	153,72 <b>186,00</b>	159,50 <b>193,00</b>	153,72 <b>186,00</b>	166,12 <b>201,00</b>	184,30 <b>223,00</b>
	130,58 <b>158,00</b>	143,80 <b>174,00</b>	146,28 <b>177,00</b>	138,84 <b>168,00</b>	146,28 <b>177,00</b>	151,24 <b>183,00</b>	144,63 <b>175,00</b>	153,72 <b>186,00</b>	159,50 <b>193,00</b>	153,72 <b>186,00</b>	166,12 <b>201,00</b>	184,30 <b>223,00</b>
	130,58 <b>158,00</b>	143,80 <b>174,00</b>	146,28 <b>177,00</b>	138,84 <b>168,00</b>	146,28 <b>177,00</b>	151,24 <b>183,00</b>	144,63 <b>175,00</b>	153,72 <b>186,00</b>	159,50 <b>193,00</b>	153,72 <b>186,00</b>	166,12 <b>201,00</b>	184,30 <b>223,00</b>
	130,58 <b>158,00</b>	143,80 <b>174,00</b>	146,28 <b>177,00</b>	138,84 <b>168,00</b>	146,28 <b>177,00</b>	151,24 <b>183,00</b>	144,63 <b>175,00</b>	153,72 <b>186,00</b>	159,50 <b>193,00</b>	153,72 <b>186,00</b>	166,12 <b>201,00</b>	184,30 <b>223,00</b>
	130,58 <b>158,00</b>	143,80 <b>174,00</b>	146,28 <b>177,00</b>	138,84 <b>168,00</b>	146,28 <b>177,00</b>	151,24 <b>183,00</b>	144,63 <b>175,00</b>	153,72 <b>186,00</b>	159,50 <b>193,00</b>	153,72 <b>186,00</b>	166,12 <b>201,00</b>	184,30 <b>223,00</b>
	130,58 <b>158,00</b>	143,80 <b>174,00</b>	146,28 <b>177,00</b>	138,84 <b>168,00</b>	146,28 <b>177,00</b>	151,24 <b>183,00</b>	144,63 <b>175,00</b>	153,72 <b>186,00</b>	159,50 <b>193,00</b>	153,72 <b>186,00</b>	166,12 <b>201,00</b>	184,30 <b>223,00</b>
	130,58 <b>158,00</b>	143,80 <b>174,00</b>	146,28 <b>177,00</b>	138,84 <b>168,00</b>	146,28 <b>177,00</b>	151,24 <b>183,00</b>	144,63 <b>175,00</b>	153,72 <b>186,00</b>	159,50 <b>193,00</b>	153,72 <b>186,00</b>	166,12 <b>201,00</b>	184,30 <b>223,00</b>
	130,58 <b>158,00</b>	143,80 <b>174,00</b>	146,28 <b>177,00</b>	138,84 <b>168,00</b>	146,28 <b>177,00</b>	151,24 <b>183,00</b>	144,63 <b>175,00</b>	153,72 <b>186,00</b>	159,50 <b>193,00</b>	153,72 <b>186,00</b>	166,12 <b>201,00</b>	184,30 <b>223,00</b>
	130,58 <b>158,00</b>	143,80 <b>174,00</b>	146,28 <b>177,00</b>	138,84 <b>168,00</b>	146,28 <b>177,00</b>	151,24 <b>183,00</b>	144,63 <b>175,00</b>	153,72 <b>186,00</b>	159,50 <b>193,00</b>	153,72 <b>186,00</b>	166,12 <b>201,00</b>	184,30 <b>223,00</b>
	130,58 <b>158,00</b>	143,80 <b>174,00</b>	146,28 <b>177,00</b>	138,84 <b>168,00</b>	146,28 <b>177,00</b>	151,24 <b>183,00</b>	144,63 <b>175,00</b>	153,72 <b>186,00</b>	159,50 <b>193,00</b>	153,72 <b>186,00</b>	166,12 <b>201,00</b>	184,30 <b>223,00</b>
	130,58 <b>158,00</b>	143,80 <b>174,00</b>	146,28 <b>177,00</b>	138,84 <b>168,00</b>	146,28 <b>177,00</b>	151,24 <b>183,00</b>	144,63 <b>175,00</b>	153,72 <b>186,00</b>	159,50 <b>193,00</b>	153,72 <b>186,00</b>	166,12 <b>201,00</b>	184,30 <b>223,00</b>
	130,58 <b>158,00</b>	143,80 <b>174,00</b>	146,28 <b>177,00</b>	138,84 <b>168,00</b>	146,28 <b>177,00</b>	151,24 <b>183,00</b>	144,63 <b>175,00</b>	153,72 <b>186,00</b>	159,50 <b>193,00</b>	153,72 <b>186,00</b>	166,12 <b>201,00</b>	184,30 <b>223,00</b>

Izmērs (cm)

CK02

CK04

CK06

FK04

FK06

FK08

MK04

MK06

**KOMBINĒTĀS IEBŪVĒŠANAS KOMPLEKTS IETVER: PIESLĒGUMU DIVIEM LOGIEM BLAKUS, BDX SILTUMIZOLĀCIJU, BFX DIFŪZIJAS MEMBRĀNU UN DRENĀŽAS NOTEKU, SPĀRI STARP LOGIEM UN TĀS DEKORATĪVU PĀRSEGU.**

**Logi ar 100 mm atstarpi**

Iebūvēšanas  
slīpums

**Standarta iebūvēšanas līmenis (sarkanais līmenis)**

Kods	Apraksts	Izmērs (cm)	CK02	CK04	CK06	FK04	FK06	FK08	MK04	MK06
EKW 4021E2	Profilētiem jumta segumiem ar profila augstumu līdz 120 mm	15-90	411,58 <b>498,00</b>	443,80 <b>537,00</b>	471,90 <b>571,00</b>	459,50 <b>556,00</b>	497,52 <b>602,00</b>	544,62 <b>659,00</b>	485,95 <b>588,00</b>	519,00 <b>628,00</b>
EKW 4021E3	Profilētiem jumta segumiem ar profila augstumu līdz 120 mm	15-90	411,58 <b>498,00</b>	443,80 <b>537,00</b>	471,90 <b>571,00</b>	459,50 <b>556,00</b>	497,52 <b>602,00</b>	544,62 <b>659,00</b>	485,95 <b>588,00</b>	519,00 <b>628,00</b>
EKT 4021E	Plakaniem dakstiņiem 15-40 mm biezumā	20-90	427,27 <b>517,00</b>	435,55 <b>527,00</b>	448,76 <b>543,00</b>	454,54 <b>550,00</b>	484,29 <b>586,00</b>	505,78 <b>612,00</b>	490,90 <b>594,00</b>	512,39 <b>620,00</b>
EKS 4021E2	Plakaniem jumta segumiem ar augstumu līdz 16 mm (2 x 8 mm)	15-90	411,58 <b>498,00</b>	443,80 <b>537,00</b>	471,90 <b>571,00</b>	459,50 <b>556,00</b>	497,52 <b>602,00</b>	544,62 <b>659,00</b>	485,95 <b>588,00</b>	519,00 <b>628,00</b>
EKS 4021E3	Plakaniem jumta segumiem ar augstumu līdz 16 mm (2 x 8 mm)	15-90	411,58 <b>498,00</b>	443,80 <b>537,00</b>	471,90 <b>571,00</b>	459,50 <b>556,00</b>	497,52 <b>602,00</b>	544,62 <b>659,00</b>	485,95 <b>588,00</b>	519,00 <b>628,00</b>
EKB 4021E	Vienkāršu bebrastes dakstiņu jumtiem līdz 38 mm (2 x 19 mm)	25-90	427,28 <b>517,00</b>	435,54 <b>527,00</b>	448,77 <b>543,00</b>	454,55 <b>550,00</b>	484,29 <b>586,00</b>	505,78 <b>612,00</b>	490,90 <b>594,00</b>	512,39 <b>620,00</b>
EKL 4021E2	Jumta segumiem ar augstumu līdz 16 mm	15-90	411,58 <b>498,00</b>	443,80 <b>537,00</b>	471,90 <b>571,00</b>	459,50 <b>556,00</b>	497,52 <b>602,00</b>	544,62 <b>659,00</b>	485,95 <b>588,00</b>	519,00 <b>628,00</b>
EKL 4021E3	Jumta segumiem ar augstumu līdz 16 mm	15-90	411,58 <b>498,00</b>	443,80 <b>537,00</b>	471,90 <b>571,00</b>	459,50 <b>556,00</b>	497,52 <b>602,00</b>	544,62 <b>659,00</b>	485,95 <b>588,00</b>	519,00 <b>628,00</b>
EKP 4021E	Vienkāršu dakstiņu jumtiem līdz 28 mm (2 x 14 mm)	25-90	427,28 <b>517,00</b>	435,54 <b>527,00</b>	448,77 <b>543,00</b>	-	484,29 <b>586,00</b>	-	490,90 <b>594,00</b>	512,39 <b>620,00</b>

**Padziļināts iebūvēšanas līmenis 40 mm dziļāk jumta konstrukcijā (zilais līmenis)**

EKJ 4021E	Plakaniem vai profilētiem jumta segumiem ar augstumu līdz 90 mm	20-90	460,33 <b>557,00</b>	470,25 <b>569,00</b>	485,12 <b>587,00</b>	490,90 <b>594,00</b>	522,31 <b>632,00</b>	547,10 <b>662,00</b>	528,92 <b>640,00</b>	553,71 <b>670,00</b>
-----------	---	-------	-------------------------	-------------------------	-------------------------	-------------------------	-------------------------	-------------------------	-------------------------	-------------------------

**Logi ar 18 mm atstarpi**

**Standarta iebūvēšanas līmenis (sarkanais līmenis)**

Kods	Apraksts	Izmērs (cm)	CK02	CK04	CK06	FK04	FK06	FK08	MK04	MK06
EBW 4021B	Profilētiem jumta segumiem ar profila augstumu līdz 120 mm	15-90	457,86 <b>554,00</b>	466,95 <b>565,00</b>	481,00 <b>582,00</b>	486,78 <b>589,00</b>	518,18 <b>627,00</b>	542,15 <b>656,00</b>	524,79 <b>635,00</b>	548,76 <b>664,00</b>
EBS 4021B	Plakaniem jumta segumiem ar augstumu līdz 16 mm (2 x 8 mm)	15-90	445,46 <b>539,00</b>	453,72 <b>549,00</b>	466,95 <b>565,00</b>	472,73 <b>572,00</b>	504,13 <b>610,00</b>	526,45 <b>637,00</b>	510,74 <b>618,00</b>	533,06 <b>645,00</b>
EBL 4021B	Jumta segumiem ar augstumu līdz 16 mm	15-90	445,46 <b>539,00</b>	453,72 <b>549,00</b>	466,95 <b>565,00</b>	472,73 <b>572,00</b>	504,13 <b>610,00</b>	526,45 <b>637,00</b>	510,74 <b>618,00</b>	533,06 <b>645,00</b>
EBP 4021B	Vienkāršu dakstiņu jumtiem līdz 28 mm (2 x 14 mm)	25-90	445,46 <b>539,00</b>	453,72 <b>549,00</b>	466,95 <b>565,00</b>	-	504,13 <b>610,00</b>	-	510,74 <b>618,00</b>	533,06 <b>645,00</b>

Iebūvēšanas komplekts ir saderīgs ar visu veidu VELUX jumta logiem. Jumta logi nav iekļauti, tie jāpasūta atsevišķi. Lai iegūtu vairāk informācijas, lūdzu sazināties ar VELUX klientu servisu.

	MK08	MK10	MK12	PK06	PK08	PK10	SK06	SK08	SK10	UK04	UK08
	569,41 <b>689,00</b>	629,75 <b>762,00</b>	-	569,42 <b>689,00</b>	619,83 <b>750,00</b>	660,33 <b>799,00</b>	609,91 <b>738,00</b>	661,98 <b>801,00</b>	705,79 <b>854,00</b>	625,62 <b>757,00</b>	705,78 <b>854,00</b>
	569,41 <b>689,00</b>	629,75 <b>762,00</b>	-	569,42 <b>689,00</b>	619,83 <b>750,00</b>	660,33 <b>799,00</b>	609,91 <b>738,00</b>	661,98 <b>801,00</b>	705,79 <b>854,00</b>	625,62 <b>757,00</b>	705,78 <b>854,00</b>
	536,35 <b>649,00</b>	584,28 <b>707,00</b>	-	579,33 <b>701,00</b>	604,14 <b>731,00</b>	621,49 <b>752,00</b>	625,62 <b>757,00</b>	656,20 <b>794,00</b>	676,86 <b>819,00</b>	670,25 <b>811,00</b>	711,58 <b>861,00</b>
	569,41 <b>689,00</b>	629,75 <b>762,00</b>	-	569,42 <b>689,00</b>	619,83 <b>750,00</b>	660,33 <b>799,00</b>	609,91 <b>738,00</b>	661,98 <b>801,00</b>	705,79 <b>854,00</b>	625,62 <b>757,00</b>	705,78 <b>854,00</b>
	569,41 <b>689,00</b>	629,75 <b>762,00</b>	-	569,42 <b>689,00</b>	619,83 <b>750,00</b>	660,33 <b>799,00</b>	609,91 <b>738,00</b>	661,98 <b>801,00</b>	705,79 <b>854,00</b>	625,62 <b>757,00</b>	705,78 <b>854,00</b>
	536,36 <b>649,00</b>	584,29 <b>707,00</b>	-	579,33 <b>701,00</b>	604,14 <b>731,00</b>	621,49 <b>752,00</b>	625,62 <b>757,00</b>	656,20 <b>794,00</b>	676,86 <b>819,00</b>	670,25 <b>811,00</b>	711,57 <b>861,00</b>
	569,41 <b>689,00</b>	629,75 <b>762,00</b>	-	569,42 <b>689,00</b>	619,83 <b>750,00</b>	660,33 <b>799,00</b>	609,91 <b>738,00</b>	661,98 <b>801,00</b>	705,79 <b>854,00</b>	625,62 <b>757,00</b>	705,78 <b>854,00</b>
	569,41 <b>689,00</b>	629,75 <b>762,00</b>	-	569,42 <b>689,00</b>	619,83 <b>750,00</b>	660,33 <b>799,00</b>	609,91 <b>738,00</b>	661,98 <b>801,00</b>	705,79 <b>854,00</b>	625,62 <b>757,00</b>	705,78 <b>854,00</b>
	536,36 <b>649,00</b>	-	-	-	604,14 <b>731,00</b>	621,49 <b>752,00</b>	625,62 <b>757,00</b>	-	-	670,25 <b>811,00</b>	711,57 <b>861,00</b>
	580,99 <b>703,00</b>	632,22 <b>765,00</b>	641,32 <b>776,00</b>	625,61 <b>757,00</b>	653,72 <b>791,00</b>	672,73 <b>814,00</b>	673,56 <b>815,00</b>	707,44 <b>856,00</b>	729,74 <b>883,00</b>	721,49 <b>873,00</b>	767,78 <b>929,00</b>
	576,03 <b>697,00</b>	626,44 <b>758,00</b>		620,66 <b>751,00</b>	648,76 <b>785,00</b>	666,95 <b>807,00</b>	669,42 <b>810,00</b>	701,65 <b>849,00</b>	724,80 <b>877,00</b>	715,70 <b>866,00</b>	761,98 <b>922,00</b>
	560,33 <b>678,00</b>	609,09 <b>737,00</b>		603,30 <b>730,00</b>	629,75 <b>762,00</b>	647,94 <b>784,00</b>	651,24 <b>788,00</b>	682,65 <b>826,00</b>	704,96 <b>853,00</b>	696,70 <b>843,00</b>	741,32 <b>897,00</b>
	560,33 <b>678,00</b>	609,09 <b>737,00</b>		603,30 <b>730,00</b>	629,75 <b>762,00</b>	647,94 <b>784,00</b>	651,24 <b>788,00</b>	682,65 <b>826,00</b>	704,96 <b>853,00</b>	696,70 <b>843,00</b>	741,32 <b>897,00</b>
	560,33 <b>678,00</b>	-		-	629,75 <b>762,00</b>	647,94 <b>784,00</b>	651,24 <b>788,00</b>	-	-	696,70 <b>843,00</b>	741,32 <b>897,00</b>

Cenas bez PVN, Euro  
Cenas ar PVN, Euro

		Izmērs (cm)	CK02	CK04	CK06	FK04	FK06	FK08	MK04	MK06	
<b>IEBŪVĒŠANAS KOMPLEKTS TRĪS KOMBINĒTU LOGU IEBŪVĒŠANAI, KAS NOVĪETOTI RINDĀ (VIENS-BLAKUS-OTRAM) IETVER PIESLĒGUMU, SILTUMIZOLĀCIJAS RĀMI BDX, DIFŪZIJAS MEMBRĀNU BFX UN DRENĀŽAS NOTEKU, KĀ ARĪ SPĀRES STARP LOGIEM UN TO DEKORATĪVOS PĀRSEGUS.</b>											
<b>Logi ar 100 mm atstarpi</b>											
Iebūvēšanas slīpums											
<b>Standarta iebūvēšanas līmenis (sarkanais līmenis)</b>											
<b>EKW 4031E2</b>	Profilētiem jumta segumiem ar profila augstumu līdz 120 mm	15-90	651,25 <b>788,00</b>	713,22 <b>863,00</b>	764,46 <b>925,00</b>	753,72 <b>912,00</b>	819,83 <b>992,00</b>	906,60 <b>1 097,00</b>	797,52 <b>965,00</b>	856,19 <b>1 036,00</b>	
<b>EKW 4031E3</b>	Profilētiem jumta segumiem ar profila augstumu līdz 120 mm	15-90	651,25 <b>788,00</b>	713,22 <b>863,00</b>	764,46 <b>925,00</b>	753,72 <b>912,00</b>	819,83 <b>992,00</b>	906,60 <b>1 097,00</b>	797,52 <b>965,00</b>	856,19 <b>1 036,00</b>	
<b>EKS 4031E2</b>	Plakaniem jumta segumiem ar augstumu līdz 16 mm (2 x 8 mm)	15-90	651,25 <b>788,00</b>	713,22 <b>863,00</b>	764,46 <b>925,00</b>	753,72 <b>912,00</b>	819,83 <b>992,00</b>	906,60 <b>1 097,00</b>	797,52 <b>965,00</b>	856,19 <b>1 036,00</b>	
<b>EKS 4031E3</b>	Plakaniem jumta segumiem ar augstumu līdz 16 mm (2 x 8 mm)	15-90	651,25 <b>788,00</b>	713,22 <b>863,00</b>	764,46 <b>925,00</b>	753,72 <b>912,00</b>	819,83 <b>992,00</b>	906,60 <b>1 097,00</b>	797,52 <b>965,00</b>	856,19 <b>1 036,00</b>	
<b>EKL 4031E2</b>	Jumta segumiem ar augstumu līdz 16 mm	15-90	651,25 <b>788,00</b>	713,22 <b>863,00</b>	764,46 <b>925,00</b>	753,72 <b>912,00</b>	819,83 <b>992,00</b>	906,60 <b>1 097,00</b>	797,52 <b>965,00</b>	856,19 <b>1 036,00</b>	
<b>EKL 4031E3</b>	Jumta segumiem ar augstumu līdz 16 mm	15-90	651,25 <b>788,00</b>	713,22 <b>863,00</b>	764,46 <b>925,00</b>	753,72 <b>912,00</b>	819,83 <b>992,00</b>	906,60 <b>1 097,00</b>	797,52 <b>965,00</b>	856,19 <b>1 036,00</b>	

Iebūvēšanas komplekts ir saderīgs ar visu veidu VELUX jumta logiem. Jumta logi nav iekļauti, tie jāpasūta atsevišķi. Lai iegūtu vairāk informācijas, lūdzu sazināties ar VELUX klientu servisu.

Cenas bez PVN, Euro  
Cenas ar PVN, Euro

		Izmērs (cm)	FK06	FK08	MK04	MK06	MK08	MK10	PK06	PK08	
<b>MINI JUMTA IZBŪVE</b>											
Iebūvēšanas slīpums											
<b>EAW 6000</b>	Mini jumta izbūve, pieslēgums EAW profilētiem jumta segumiem ar profila augstumu līdz 120 mm, viena jumta loga iebūvēšanai mini jumta izbūvē	10-75	628,93 <b>761,00</b>	661,98 <b>801,00</b>	628,93 <b>761,00</b>	661,98 <b>801,00</b>	701,65 <b>849,00</b>	774,38 <b>937,00</b>	747,93 <b>905,00</b>	787,61 <b>953,00</b>	

Cenas bez PVN, Euro  
Cenas ar PVN, Euro

		Izmērs (cm)	MK06 78x118	PK06 94x118	SK06 114x118
<b>JUMTA IZBŪVE</b>					
Iebūvēšanas slīpums					
<b>EBW 2022BK</b>	Jumta izbūve, pieslēgums EAW profilētiem jumta segumiem ar profila augstumu līdz 120 mm, kombinētai 4 jumta logu iebūvēšanai jumta izbūvē	35-70	2 528,10 <b>3 059,00</b>	2 842,15 <b>3 439,00</b>	2 895,87 <b>3 504,00</b>
<b>EBW 2032BK</b>	Jumta izbūve, pieslēgums EAW profilētiem jumta segumiem ar profila augstumu līdz 120 mm, kombinētai 6 jumta logu iebūvēšanai jumta izbūvē	35-70	3 013,22 <b>3 646,00</b>	-	-

Mini jumta izbūve un izbūves pieslēgums ļauj VELUX jumta logu iebūvēt, virs jumta līmeņa, tādējādi radot papildu platību no iekšpuses. Jumta izbūves un pieslēgumi perfekti sader ar konkrētā izmēra jumta logu, tādējādi radot ūdensnecaurlaidīgu un labi blīvētu risinājumu.



	MK08	MK10	MK12
	947,92 <b>1 147,00</b>	1 052,89 <b>1 274,00</b>	1 112,39 <b>1 346,00</b>
	947,92 <b>1 147,00</b>	1 052,89 <b>1 274,00</b>	1 112,39 <b>1 346,00</b>
	947,92 <b>1 147,00</b>	1 052,89 <b>1 274,00</b>	-
	947,92 <b>1 147,00</b>	1 052,89 <b>1 274,00</b>	-
	947,92 <b>1 147,00</b>	1 052,89 <b>1 274,00</b>	1 112,39 <b>1 346,00</b>
	947,92 <b>1 147,00</b>	1 052,89 <b>1 274,00</b>	1 112,39 <b>1 346,00</b>

PK10	SK06	SK08	SK10	UK04	UK08	UK10
814,05 <b>985,00</b>	780,99 <b>945,00</b>	827,27 <b>1 001,00</b>	860,33 <b>1 041,00</b>	827,27 <b>1 001,00</b>	893,39 <b>1 081,00</b>	993,39 <b>1 202,00</b>

## JUMTA IZBŪVE

Minimālais griestu  
augstums (B),  
atkarībā no jumta  
slīpuma (A)

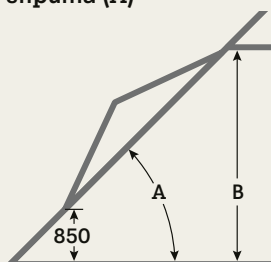

A	min. B mm
35°	2 003
40°	2 171
45°	2 328
50°	2 470
55°	2 600
60°	2 714
65°	2 815
70°	2 900

## Pieejamie izmēri

Izmēra kods	Jumta logu kombinācija	Produkta kods
<b>MK06</b>	2×2 jumta logi vai 2×3 jumta logi	EBW MK06 2022BK EBW MK06 2032BK
<b>PK06</b>	2×2 jumta logi	EBW PK06 2022BK
<b>SK06</b>	2×2 jumta logi	EBW SK06 2022BK



Cenas bez PVN, Eiro  
Cenas ar PVN, Eiro

MK31  
78x60

MK35  
78x95

MK36  
78x115

MK38  
78x137

PK31  
94x60

PK35  
94x95

PK36  
94x115

PK38  
94x137

## VERTIKĀLI LOGA ELEMENTI, VERAMI

				W/(m <sup>2</sup> K) Iebūvēšanas slīpums								
VFE 3070	Verams ar roku, priedes koks, apstrādāts ar trīskāršu pārklājumu, caurspīdīgs lakojušs, vienkameras stikla pakete	1.3	15-55	435,54 <b>527,00</b>	488,43 <b>591,00</b>	519,83 <b>629,00</b>	541,32 <b>655,00</b>	499,17 <b>604,00</b>	552,07 <b>668,00</b>	573,55 <b>694,00</b>	594,21 <b>719,00</b>	
VFE 3068	Verams ar roku, priedes koks, apstrādāts ar trīskāršu pārklājumu, caurspīdīgs lakojušs, divkameru stikla pakete	1.1	15-55	543,80 <b>658,00</b>	610,74 <b>739,00</b>	650,41 <b>787,00</b>	676,86 <b>819,00</b>	623,97 <b>755,00</b>	690,08 <b>835,00</b>	716,53 <b>867,00</b>	742,98 <b>899,00</b>	
VFE 3066	Verams ar roku, priedes koks, apstrādāts ar trīskāršu pārklājumu, caurspīdīgs lakojušs, divkameru stikla pakete	1.0	15-55	609,09 <b>737,00</b>	683,47 <b>827,00</b>	-	-	698,35 <b>845,00</b>	772,73 <b>935,00</b>	-	-	
VFE 3062	Verams ar roku, priedes koks, apstrādāts ar trīskāršu pārklājumu, caurspīdīgs lakojušs, divkameru stikla pakete	1.0	15-55	757,02 <b>916,00</b>	849,59 <b>1 028,00</b>	-	-	867,77 <b>1 050,00</b>	960,33 <b>1 162,00</b>	-	-	
VFA 3070	Verams ar roku, priedes koks, apstrādāts ar trīskāršu pārklājumu, caurspīdīgs lakojušs, vienkameras stikla pakete	1.3	15-55	-	563,64 <b>682,00</b>	600,00 <b>726,00</b>	624,79 <b>756,00</b>	-	637,19 <b>771,00</b>	661,16 <b>800,00</b>	685,95 <b>830,00</b>	
VFA 3068	Verams ar roku, priedes koks, apstrādāts ar trīskāršu pārklājumu, caurspīdīgs lakojušs, divkameru stikla pakete	1.1	15-55	-	704,13 <b>852,00</b>	750,41 <b>908,00</b>	780,99 <b>945,00</b>	-	795,87 <b>963,00</b>	826,45 <b>1 000,00</b>	857,02 <b>1 037,00</b>	
VFA 3066	Verams ar roku, priedes koks, apstrādāts ar trīskāršu pārklājumu, caurspīdīgs lakojušs, divkameru stikla pakete	1.0	15-55	-	788,43 <b>954,00</b>	840,50 <b>1 017,00</b>	874,38 <b>1 058,00</b>	-	891,74 <b>1 079,00</b>	925,62 <b>1 120,00</b>	960,33 <b>1 162,00</b>	
VFB 3070	Verams ar roku, priedes koks, apstrādāts ar trīskāršu pārklājumu, caurspīdīgs lakojušs, vienkameras stikla pakete	1.3	15-55	-	563,64 <b>682,00</b>	600,00 <b>726,00</b>	624,79 <b>756,00</b>	-	637,19 <b>771,00</b>	661,16 <b>800,00</b>	685,95 <b>830,00</b>	
VFB 3068	Verams ar roku, priedes koks, apstrādāts ar trīskāršu pārklājumu, caurspīdīgs lakojušs, divkameru stikla pakete	1.1	15-55	-	704,13 <b>852,00</b>	750,41 <b>908,00</b>	780,99 <b>945,00</b>	-	795,87 <b>963,00</b>	826,45 <b>1 000,00</b>	857,02 <b>1 037,00</b>	
VFB 3066	Verams ar roku, priedes koks, apstrādāts ar trīskāršu pārklājumu, caurspīdīgs lakojušs, divkameru stikla pakete	1.0	15-55	-	788,43 <b>954,00</b>	840,50 <b>1 017,00</b>	874,38 <b>1 058,00</b>	-	891,74 <b>1 079,00</b>	925,62 <b>1 120,00</b>	960,33 <b>1 162,00</b>	

VFE/VFA/VFB vertikālie logi ir paredzēti iebūvēšanai kopā ar jumta logiem GGL/GPL/GLL/GZL vai GIL logu.  
VFE/VFA/VFB logu nevar uzstādīt atsevišķi.

	 SK31 114x60	 SK35 114x95	 SK36 114x115	 SK38 114x137	 UK31 134x60	 UK35 134x95	 UK36 134x115	 UK38 134x137
	557,02 <b>674,00</b>	604,96 <b>732,00</b>	615,70 <b>745,00</b>	637,19 <b>771,00</b>	604,96 <b>732,00</b>	657,85 <b>796,00</b>	668,60 <b>809,00</b>	711,57 <b>861,00</b>
	696,69 <b>843,00</b>	756,20 <b>915,00</b>	769,42 <b>931,00</b>	-	756,20 <b>915,00</b>	822,31 <b>995,00</b>	-	-
	780,17 <b>944,00</b>	847,11 <b>1 025,00</b>	-	-	847,11 <b>1 025,00</b>	921,49 <b>1 115,00</b>	-	-
	969,42 <b>1 173,00</b>	1 052,89 <b>1 274,00</b>	-	-	1 052,89 <b>1 274,00</b>	1 145,45 <b>1 386,00</b>	-	-
	-	698,35 <b>845,00</b>	710,74 <b>860,00</b>	734,71 <b>889,00</b>	-	-	-	-
	-	872,73 <b>1 056,00</b>	887,60 <b>1 074,00</b>	919,01 <b>1 112,00</b>	-	-	-	-
	-	977,69 <b>1 183,00</b>	994,21 <b>1 203,00</b>	1 028,93 <b>1 245,00</b>	-	-	-	-
	-	698,35 <b>845,00</b>	710,74 <b>860,00</b>	734,71 <b>889,00</b>	-	-	-	-
	-	872,73 <b>1 056,00</b>	887,60 <b>1 074,00</b>	919,01 <b>1 112,00</b>	-	-	-	-
	-	977,69 <b>1 183,00</b>	994,21 <b>1 203,00</b>	1 028,93 <b>1 245,00</b>	-	-	-	-



Cenas bez PVN, Euro  
Cenas ar PVN, Euro



MK31  
78x60



MK35  
78x95



MK36  
78x115



MK38  
78x137



PK31  
94x60



PK35  
94x95



PK36  
94x115



PK38  
94x137

## VERTIKĀLI LOGA ELEMENTI, VERAMI

		W/(m <sup>2</sup> K) Iebūvēšanas slīpums										
VFE 2070	Verams ar roku, priedes koks, apstrādāts ar trīskāršu pārklājumu, balti krāsots, vienkameras stikla pakete	1.3	15-55	435,54 <b>527,00</b>	488,43 <b>591,00</b>	519,83 <b>629,00</b>	541,32 <b>655,00</b>	499,17 <b>604,00</b>	552,07 <b>668,00</b>	573,55 <b>694,00</b>	594,21 <b>719,00</b>	
VFE 2068	Verams ar roku, priedes koks, apstrādāts ar trīskāršu pārklājumu, balti krāsots, divkameru stikla pakete	1.1	15-55	543,80 <b>658,00</b>	610,74 <b>739,00</b>	-	-	623,97 <b>755,00</b>	690,08 <b>835,00</b>	-	-	
VFE 2066	Verams ar roku, priedes koks, apstrādāts ar trīskāršu pārklājumu, balti krāsots, divkameru stikla pakete	1.0	15-55	609,09 <b>737,00</b>	683,47 <b>827,00</b>	-	-	698,35 <b>845,00</b>	772,73 <b>935,00</b>	-	-	
VFE 2062	Verams ar roku, priedes koks, apstrādāts ar trīskāršu pārklājumu, balti krāsots, divkameru stikla pakete	1.0	15-55	757,02 <b>916,00</b>	849,59 <b>1 028,00</b>	-	-	867,77 <b>1 050,00</b>	960,33 <b>1 162,00</b>	-	-	
VFA 2070	Verams ar roku, priedes koks, apstrādāts ar trīskāršu pārklājumu, balti krāsots, vienkameras stikla pakete	1.3	15-55	-	563,64 <b>682,00</b>	600,00 <b>726,00</b>	624,79 <b>756,00</b>	-	637,19 <b>771,00</b>	661,16 <b>800,00</b>	685,95 <b>830,00</b>	
VFA 2068	Verams ar roku, priedes koks, apstrādāts ar trīskāršu pārklājumu, balti krāsots, divkameru stikla pakete	1.1	15-55	-	704,13 <b>852,00</b>	750,41 <b>908,00</b>	780,99 <b>945,00</b>	-	795,87 <b>963,00</b>	826,45 <b>1 000,00</b>	857,02 <b>1 037,00</b>	
VFA 2066	Verams ar roku, priedes koks, apstrādāts ar trīskāršu pārklājumu, balti krāsots, divkameru stikla pakete	1.0	15-55	-	788,43 <b>954,00</b>	840,50 <b>1 017,00</b>	874,38 <b>1 058,00</b>	-	891,74 <b>1 079,00</b>	925,62 <b>1 120,00</b>	960,33 <b>1 162,00</b>	
VFB 2070	Verams ar roku, priedes koks, apstrādāts ar trīskāršu pārklājumu, balti krāsots, vienkameras stikla pakete	1.3	15-55	-	563,64 <b>682,00</b>	600,00 <b>726,00</b>	624,79 <b>756,00</b>	-	637,19 <b>771,00</b>	661,16 <b>800,00</b>	685,95 <b>830,00</b>	
VFB 2068	Verams ar roku, priedes koks, apstrādāts ar trīskāršu pārklājumu, balti krāsots, divkameru stikla pakete	1.1	15-55	-	704,13 <b>852,00</b>	750,41 <b>908,00</b>	780,99 <b>945,00</b>	-	795,87 <b>963,00</b>	826,45 <b>1 000,00</b>	857,02 <b>1 037,00</b>	
VFB 2066	Verams ar roku, priedes koks, apstrādāts ar trīskāršu pārklājumu, balti krāsots, divkameru stikla pakete	1.0	15-55	-	788,43 <b>954,00</b>	840,50 <b>1 017,00</b>	874,38 <b>1 058,00</b>	-	891,74 <b>1 079,00</b>	925,62 <b>1 120,00</b>	960,33 <b>1 162,00</b>	

VFE/VFA/VFB vertikālie loga elementi ir paredzēti iebūvēšanai kopā ar jumta logiem GGL/GPL/GLL/GZL vai GIL logu.  
VFE/VFA/VFB logu nevar iebūvēt atsevišķi.



Cenas bez PVN, Euro  
Cenas ar PVN, Euro



MK31  
78x60



MK35  
78x95



MK36  
78x115



MK38  
78x137



PK31  
94x60



PK35  
94x95



PK36  
94x115











PK38  
94x137





## VERTIKĀLI LOGA ELEMENTI, NEVERAMI

		W/(m <sup>2</sup> K) Iebūvēšanas slīpums										
VIU 0070	Neverams, balts poliuretāns ap koka kodolu ar papildu izturīgu pārklājumu, vienkameras stikla pakete	1.3	15-55	378,51 <b>458,00</b>	424,79 <b>514,00</b>	452,07 <b>547,00</b>	470,25 <b>569,00</b>	433,88 <b>525,00</b>	480,17 <b>581,00</b>	498,35 <b>603,00</b>	516,53 <b>625,00</b>	
VIU 0068	Neverams, balts poliuretāns ap koka kodolu ar papildu izturīgu pārklājumu, divkameru stikla pakete	1.1	15-55	472,73 <b>572,00</b>	530,58 <b>642,00</b>	-	-	542,15 <b>656,00</b>	600,00 <b>726,00</b>	-	-	
VIU 0066	Neverams, balts poliuretāns ap koka kodolu ar papildu izturīgu pārklājumu, divkameru stikla pakete	1.0	15-55	529,75 <b>641,00</b>	594,21 <b>719,00</b>	-	-	607,44 <b>735,00</b>	671,90 <b>813,00</b>	-	-	
VIU 0062	Neverams, balts poliuretāns ap koka kodolu ar papildu izturīgu pārklājumu, divkameru stikla pakete	1.0	15-55	657,85 <b>796,00</b>	738,84 <b>894,00</b>	-	-	754,55 <b>913,00</b>	834,71 <b>1 010,00</b>	-	-	

VIU vertikālie loga elementi ir paredzēti iebūvēšanai zem GGU/GLU/GPU jumta loga,  
VIU logu nevar uzstādīt atsevišķi.

							
SK31 114x60	SK35 114x95	SK36 114x115	SK38 114x137	UK31 134x60	UK35 134x95	UK36 134x115	UK38 134x137

557,02 <b>674,00</b>	604,96 <b>732,00</b>	615,70 <b>745,00</b>	637,19 <b>771,00</b>	604,96 <b>732,00</b>	657,85 <b>796,00</b>	668,60 <b>809,00</b>	711,57 <b>861,00</b>
696,69 <b>843,00</b>	756,20 <b>915,00</b>	-	-	756,20 <b>915,00</b>	822,31 <b>995,00</b>	-	-
780,17 <b>944,00</b>	847,11 <b>1 025,00</b>	-	-	847,11 <b>1 025,00</b>	921,49 <b>1 115,00</b>	-	-
969,42 <b>1 173,00</b>	1 052,89 <b>1 274,00</b>	-	-	1 052,89 <b>1 274,00</b>	1 145,45 <b>1 386,00</b>	-	-
-	698,35 <b>845,00</b>	710,74 <b>860,00</b>	734,71 <b>889,00</b>	-	-	-	-
-	872,73 <b>1 056,00</b>	887,60 <b>1 074,00</b>	919,01 <b>1 112,00</b>	-	-	-	-
-	977,69 <b>1 183,00</b>	994,21 <b>1 203,00</b>	1 028,93 <b>1 245,00</b>	-	-	-	-
-	698,35 <b>845,00</b>	710,74 <b>860,00</b>	734,71 <b>889,00</b>	-	-	-	-
-	872,73 <b>1 056,00</b>	887,60 <b>1 074,00</b>	919,01 <b>1 112,00</b>	-	-	-	-
-	977,69 <b>1 183,00</b>	994,21 <b>1 203,00</b>	1 028,93 <b>1 245,00</b>	-	-	-	-

			
SK31 114x60	SK35 114x95	SK36 114x115	SK38 114x137

484,30 <b>586,00</b>	525,62 <b>636,00</b>	535,54 <b>648,00</b>	553,72 <b>670,00</b>
605,79 <b>733,00</b>	657,02 <b>795,00</b>	-	-
678,51 <b>821,00</b>	736,36 <b>891,00</b>	-	-
842,98 <b>1 020,00</b>	914,88 <b>1 107,00</b>	-	-

Cenas bez PVN, Euro  
Cenas ar PVN, Euro

Izmērs (cm)

MK00  
78x+++

PK00  
94x+++

SK00  
114x+++

**FASĀDES ELEMENTA SAVIENOJUMS EFY TIEK LIETOTS, LAI SAVIENOTU VELUX JUMTA LOGU AR JEBKURU FASĀDES ELEMENTU, PIEMĒRAM, AR LOGU VAI DURVĪM. ELEMENTAM JĀBŪT VIENĀ PLATUMĀ AR EFY.**

Iebūvēšanas  
slīpums

EFY 2012	-	129,75 <b>157,00</b>	136,36 <b>165,00</b>	141,32 <b>171,00</b>
EFY 3012	-	129,75 <b>157,00</b>	136,36 <b>165,00</b>	141,32 <b>171,00</b>

Cenas bez PVN, Euro  
Cenas ar PVN, Euro

Izmērs (cm)

MK04  
78x98

MK06  
78x118

MK08  
78x140

MK10  
78x160

MK12  
78x180

PK06  
94x118

PK08  
94x140

PK10  
94x160

## JUMTA LOGU UN VERTIKĀLO LOGA ELEMENTU KOMBINĀCIJAS VFE, VFA, VFB VAI VIU VIENA LOGA IEBŪVĒŠANA KOMBINĀCIJĀ AR VERTIKĀLO LOGA ELEMENTU

Iebūvēšanas  
slīpums

### Standarta iebūvēšanas līmenis (sarkanais līmenis)

EFW 0012	Profilētiem jumta segumiem ar profila augstumu līdz 120 mm	15-55	139,67 <b>169,00</b>	147,11 <b>178,00</b>	156,20 <b>189,00</b>	171,90 <b>208,00</b>	175,21 <b>212,00</b>	166,12 <b>201,00</b>	184,30 <b>223,00</b>	180,99 <b>219,00</b>
EFS 0012	Plakaniem jumta segumiem ar augstumu līdz 16 mm (2 x 8 mm)	15-55	139,67 <b>169,00</b>	147,11 <b>178,00</b>	156,20 <b>189,00</b>	171,90 <b>208,00</b>	-	166,12 <b>201,00</b>	184,30 <b>223,00</b>	180,99 <b>219,00</b>

### Padziļināts iebūvēšanas līmenis 40 mm dziļāk jumta konstrukcijā (zilais līmenis)

EFJ 0012	Plakaniem vai profilētiem jumta segumiem ar augstumu līdz 90 mm	20-55	139,67 <b>169,00</b>	147,11 <b>178,00</b>	156,20 <b>189,00</b>	171,90 <b>208,00</b>	175,21 <b>212,00</b>	166,12 <b>201,00</b>	184,30 <b>223,00</b>	180,99 <b>219,00</b>
EFN 0012	Plakaniem jumta segumiem ar augstumu līdz 16 mm (2 x 8 mm)	20-55	139,67 <b>169,00</b>	147,11 <b>178,00</b>	156,20 <b>189,00</b>	-	175,21 <b>212,00</b>	166,12 <b>201,00</b>	184,30 <b>223,00</b>	180,99 <b>219,00</b>

## KOMBINĒTAJAI IEBŪVĒŠANAI AR VERTIKĀLIEM LOGA ELEMENTIEM

### Standarta iebūvēšanas līmenis (sarkanais līmenis)

EFW 0022E	Profilētiem jumta segumiem ar profila augstumu līdz 120 mm	15-55	345,45 <b>418,00</b>	352,89 <b>427,00</b>	361,98 <b>438,00</b>	377,69 <b>457,00</b>	380,99 <b>461,00</b>	371,90 <b>450,00</b>	390,08 <b>472,00</b>	386,78 <b>468,00</b>
EFS 0022E	Plakaniem jumta segumiem ar augstumu līdz 16 mm (2 x 8 mm)	15-55	345,45 <b>418,00</b>	352,89 <b>427,00</b>	361,98 <b>438,00</b>	377,69 <b>457,00</b>	380,99 <b>461,00</b>	371,90 <b>450,00</b>	390,08 <b>472,00</b>	386,78 <b>468,00</b>

### Padziļināts iebūvēšanas līmenis 40 mm dziļāk jumta konstrukcijā (zilais līmenis)

EFJ 0022E	Plakaniem vai profilētiem jumta segumiem ar augstumu līdz 90 mm	20-55	345,45 <b>418,00</b>	352,89 <b>427,00</b>	361,98 <b>438,00</b>	377,69 <b>457,00</b>	380,99 <b>461,00</b>	371,90 <b>450,00</b>	390,08 <b>472,00</b>	386,78 <b>468,00</b>
EFN 0022E	Plakaniem jumta segumiem ar augstumu līdz 16 mm (2 x 8 mm)	20-55	345,45 <b>418,00</b>	352,89 <b>427,00</b>	361,98 <b>438,00</b>	-	-	371,90 <b>450,00</b>	390,08 <b>472,00</b>	386,78 <b>468,00</b>

## TRĪS LOGU KOMBINĀCIJAI AR VERTIKĀLIEM LOGA ELEMENTIEM

### Standarta iebūvēšanas līmenis (sarkanais līmenis)

EFW 0032B	Profilētiem jumta segumiem ar profila augstumu līdz 120 mm	15-55	345,45 <b>418,00</b>	352,89 <b>427,00</b>	361,98 <b>438,00</b>	377,69 <b>457,00</b>	380,99 <b>461,00</b>	-	-	-
EFW 0032C	Profilētiem jumta segumiem ar profila augstumu līdz 120 mm	15-55	345,45 <b>418,00</b>	352,89 <b>427,00</b>	361,98 <b>438,00</b>	377,69 <b>457,00</b>	380,99 <b>461,00</b>	-	-	-
EFW 0032E	Profilētiem jumta segumiem ar profila augstumu līdz 120 mm	15-55	345,45 <b>418,00</b>	352,89 <b>427,00</b>	361,98 <b>438,00</b>	377,69 <b>457,00</b>	380,99 <b>461,00</b>	-	-	-
EFS 0032B	Plakaniem jumta segumiem ar augstumu līdz 16 mm (2 x 8 mm)	15-55	345,45 <b>418,00</b>	352,89 <b>427,00</b>	361,98 <b>438,00</b>	377,69 <b>457,00</b>	380,99 <b>461,00</b>	-	-	-
EFS 0032C	Plakaniem jumta segumiem ar augstumu līdz 16 mm (2 x 8 mm)	15-55	345,45 <b>418,00</b>	352,89 <b>427,00</b>	361,98 <b>438,00</b>	377,69 <b>457,00</b>	380,99 <b>461,00</b>	-	-	-
EFS 0032E	Plakaniem jumta segumiem ar augstumu līdz 16 mm (2 x 8 mm)	15-55	345,45 <b>418,00</b>	352,89 <b>427,00</b>	361,98 <b>438,00</b>	377,69 <b>457,00</b>	380,99 <b>461,00</b>	-	-	-

### Padziļināts iebūvēšanas līmenis 40 mm dziļāk jumta konstrukcijā (zilais līmenis)

EFJ 0032E	Plakaniem vai profilētiem jumta segumiem ar augstumu līdz 90 mm	20-55	345,45 <b>418,00</b>	352,89 <b>427,00</b>	361,98 <b>438,00</b>	377,69 <b>457,00</b>	380,99 <b>461,00</b>	-	-	-
EFN 0032E	Plakaniem jumta segumiem ar augstumu līdz 16 mm (2 x 8 mm)	20-55	345,45 <b>418,00</b>	352,89 <b>427,00</b>	361,98 <b>438,00</b>	-	-	-	-	-

	 SK06 114x118	 SK08 114x140	 SK10 114x160	 UK04 134x98	 UK08 134x140	 UK10 134x160
	173,55 <b>210,00</b>	184,30 <b>223,00</b>	190,91 <b>231,00</b>	184,30 <b>223,00</b>	198,35 <b>240,00</b>	220,66 <b>267,00</b>
	173,55 <b>210,00</b>	184,30 <b>223,00</b>	190,91 <b>231,00</b>	-	198,35 <b>240,00</b>	220,66 <b>267,00</b>
	173,55 <b>210,00</b>	184,30 <b>223,00</b>	190,91 <b>231,00</b>	184,30 <b>223,00</b>	198,35 <b>240,00</b>	220,66 <b>267,00</b>
	173,55 <b>210,00</b>	184,30 <b>223,00</b>	-	184,30 <b>223,00</b>	198,35 <b>240,00</b>	-
	379,34 <b>459,00</b>	390,08 <b>472,00</b>	396,69 <b>480,00</b>	390,08 <b>472,00</b>	404,13 <b>489,00</b>	426,45 <b>516,00</b>
	379,34 <b>459,00</b>	390,08 <b>472,00</b>	396,69 <b>480,00</b>	390,08 <b>472,00</b>	404,13 <b>489,00</b>	426,45 <b>516,00</b>
	379,34 <b>459,00</b>	390,08 <b>472,00</b>	396,69 <b>480,00</b>	390,08 <b>472,00</b>	404,13 <b>489,00</b>	426,45 <b>516,00</b>
	379,34 <b>459,00</b>	390,08 <b>472,00</b>	-	390,08 <b>472,00</b>	404,13 <b>489,00</b>	-
	-	-	-	-	-	-
	-	-	-	-	-	-
	-	-	-	-	-	-
	-	-	-	-	-	-
	-	-	-	-	-	-
	-	-	-	-	-	-
	-	-	-	-	-	-
	-	-	-	-	-	-



Cenas bez PVN, Euro  
Cenas ar PVN, Euro

MK34  
78x92

PK34  
94x92

SK34  
114x92

Izmērs (cm)

WK34  
+++x94

## NEVERAMS LOGA ELEMENTS

		W/(m² K)		Iebūvēšanas slīpums		
<b>GIL 3070</b>	Neverams, priedes koks, apstrādāts ar trīskāršu pārklājumu, caurspīdīgs lakojums, vienkameras stikla pakete	1.3	15-90	367,77 <b>445,00</b>	416,53 <b>504,00</b>	457,02 <b>553,00</b>
<b>GIL 3068</b>	Neverams, priedes koks, apstrādāts ar trīskāršu pārklājumu, caurspīdīgs lakojums, divkameru stikla pakete	1.1	15-90	459,50 <b>556,00</b>	520,66 <b>630,00</b>	571,90 <b>692,00</b>
<b>GIL 3066</b>	Neverams, priedes koks, apstrādāts ar trīskāršu pārklājumu, caurspīdīgs lakojums, divkameru stikla pakete	1.0	15-90	514,05 <b>622,00</b>	582,64 <b>705,00</b>	640,50 <b>775,00</b>
<b>GIU 0070</b>	Neverams, balts poliuretāns ap koka kodolu ar papildu izturīgu pārklājumu, vienkameras stikla pakete	1.3	15-90	414,88 <b>502,00</b>	470,25 <b>569,00</b>	516,53 <b>625,00</b>
<b>GIU 0068</b>	Neverams, balts poliuretāns ap koka kodolu ar papildu izturīgu pārklājumu, divkameru stikla pakete	1.1	15-90	519,01 <b>628,00</b>	588,43 <b>712,00</b>	646,28 <b>782,00</b>
<b>GIU 0066</b>	Neverams, balts poliuretāns ap koka kodolu ar papildu izturīgu pārklājumu, divkameru stikla pakete	1.0	15-90	580,99 <b>703,00</b>	658,68 <b>797,00</b>	723,14 <b>875,00</b>
<b>GIU 0062</b>	Neverams, balts poliuretāns ap koka kodolu ar papildu izturīgu pārklājumu, divkameru stikla pakete	1.0	15-90	722,31 <b>874,00</b>	819,01 <b>991,00</b>	899,17 <b>1 088,00</b>
<b>GIL 2070</b>	Neverams, priedes koks, apstrādāts ar trīskāršu pārklājumu, balti krāsots, vienkameras stikla pakete	1.3	15-90	367,77 <b>445,00</b>	416,53 <b>504,00</b>	457,02 <b>553,00</b>
<b>GIL 2068</b>	Neverams, priedes koks, apstrādāts ar trīskāršu pārklājumu, balti krāsots, divkameru stikla pakete	1.1	15-90	459,50 <b>556,00</b>	520,66 <b>630,00</b>	571,90 <b>692,00</b>
<b>GIL 2066</b>	Neverams, priedes koks, apstrādāts ar trīskāršu pārklājumu, balti krāsots, divkameru stikla pakete	1.0	15-90	514,05 <b>622,00</b>	582,64 <b>705,00</b>	640,50 <b>775,00</b>
<b>GIL 2062</b>	Neverams, priedes koks, apstrādāts ar trīskāršu pārklājumu, balti krāsots, divkameru stikla pakete	1.0	15-90	639,67 <b>774,00</b>	724,79 <b>877,00</b>	795,87 <b>963,00</b>

GIU slīpie loga elementi (loga pagarinājumi) ir paredzēti iebūvēšanai zem GGL, GPL un GLL jumta logiem. Logi tiek iebūvēti tieši zem augšējā loga rāmja, neizmantojot papildu profilus. GIL logu nevar iebūvēt atsevišķi. GIL logs ir neverams.

GIU slīpie loga elementi (loga pagarinājumi) ir paredzēti iebūvēšanai zem GGU, GPU un GLU jumta loga. Logi tiek iebūvēti tieši zem augšējā loga rāmja, neizmantojot papildus profilus. GIU logu nevar iebūvēt atsevišķi. GIU logs ir neverams.

Cenas bez PVN, Euro  
Cenas ar PVN, Euro

## JUMTA LOGS KOMBINĀCIJĀ AR NEVERAMO LOGA ELEMENTU GIL VAI GIU

Viena loga iebūvēšanai kombinācijā ar neveramo loga elementu

		Iebūvēšanas slīpums	
<b>Standarta iebūvēšanas līmenis (sarkanais līmenis)</b>			
<b>ETW 1000</b>	Profilētiem jumta segumiem ar profila augstumu līdz 120 mm	15-90	100,83 <b>122,00</b>
<b>ETW 1000S</b>	Profilētiem jumta segumiem ar profila augstumu līdz 120 mm	15-90	100,83 <b>122,00</b>
<b>ETW 2000</b>	Profilētiem jumta segumiem ar profila augstumu līdz 120 mm	15-90	114,88 <b>139,00</b>
<b>ETW 2000S</b>	Profilētiem jumta segumiem ar profila augstumu līdz 120 mm	15-90	114,88 <b>139,00</b>
<b>ETS 1000</b>	Plakaniem jumta segumiem ar augstumu līdz 16 mm (2 x 8 mm)	15-90	100,83 <b>122,00</b>
<b>ETS 2000</b>	Plakaniem jumta segumiem ar augstumu līdz 16 mm (2 x 8 mm)	15-90	114,88 <b>139,00</b>
<b>Padziļināts iebūvēšanas līmenis 40 mm dziļāk jumta konstrukcijā (zilais līmenis)</b>			
<b>ETJ 1000</b>	Plakaniem vai profilētiem jumta segumiem ar augstumu līdz 90 mm	20-90	-
<b>ETJ 2000</b>	Plakaniem vai profilētiem jumta segumiem ar augstumu līdz 90 mm	20-90	-

Cenas bez PVN, Euro  
Cenas ar PVN, Euro

Izmērs (cm)

WK34  
+++x94

## KOMBINĒTAJAI IEBŪVĒŠANAI AR NEVERAMAJIEM LOGA ELEMENTIEM

		Iebūvēšanas slīpums	
<b>Standarta iebūvēšanas līmenis (sarkanais līmenis)</b>			
<b>ETW 2000M (F, G, H)*</b>	Profilētiem jumta segumiem ar profila augstumu līdz 120 mm	15-90	114,88 <b>139,00</b>
<b>ETS 2000M (F, G, H)*</b>	Plakaniem jumta segumiem ar augstumu līdz 16 mm (2 x 8 mm)	15-90	114,88 <b>139,00</b>
<b>Padziļināts iebūvēšanas līmenis 40 mm dziļāk jumta konstrukcijā (zilais līmenis)</b>			
<b>ETJ 2000M (F, G, H)*</b>	Plakaniem vai profilētiem jumta segumiem ar augstumu līdz 90 mm	20-90	-





Cenas bez PVN, Euro  
Cenas ar PVN, Euro

MK19

PK19

SK19

## JUMTA BALKONS

		W/(m <sup>2</sup> K)		Iebūvēšanas slīpums		
<b>GDL 2066</b>	Verams ar roku, rokturis apakšā, pa augšējo asi verams, priedes koks, apstrādāts ar trīskāršu pārklājumu, balti krāsots, divkameru stikla pakete	1.3	35-53	2 205,79 <b>2 669,00</b>	-	-
<b>GDL 3066</b>	Verams ar roku, rokturis apakšā, pa augšējo asi verams, priedes koks, apstrādāts ar trīskāršu pārklājumu, caurspīdīgs lakojums, divkameru stikla pakete	1.3	35-53	2 205,79 <b>2 669,00</b>	-	-
<b>GDL 2066</b>	Verams ar roku, rokturis apakšā, pa augšējo asi verams, priedes koks, apstrādāts ar trīskāršu pārklājumu, balti krāsots, divkameru stikla pakete	1.1	35-53	-	2 371,90 <b>2 870,00</b>	-
<b>GDL 3066</b>	Verams ar roku, rokturis apakšā, pa augšējo asi verams, priedes koks, apstrādāts ar trīskāršu pārklājumu, caurspīdīgs lakojums, divkameru stikla pakete	1.1	35-53	-	2 371,90 <b>2 870,00</b>	-
<b>GDL 2066</b>	Verams ar roku, rokturis apakšā, pa augšējo asi verams, priedes koks, apstrādāts ar trīskāršu pārklājumu, balti krāsots, divkameru stikla pakete	1.1	35-53	-	-	2 538,02 <b>3 071,00</b>
<b>GDL 3066</b>	Verams ar roku, rokturis apakšā, pa augšējo asi verams, priedes koks, apstrādāts ar trīskāršu pārklājumu, caurspīdīgs lakojums, divkameru stikla pakete	1.1	35-53	-	-	2 538,02 <b>3 071,00</b>

GDL logam MK19 izmērā  $U_w = 1,3$

GDL balkona loga augšējā vārtne tiek darbināta ar apakšējo rokturi, apakšējā vārtne ar rokturu pāri. Logs ir aprīkots ar vidējo enģi, kas ļauj pagriezt vārtņi ērtākai tās tīrīšanai.

Cenas bez PVN, Euro  
Cenas ar PVN, Euro

Izmērs (cm)

MK19  
78x252

PK19  
94x252

SK19  
114x252

## JUMTA BALKONA IEBŪVĒŠANA

Hidroizolācijas risinājums 1000 ietver difūzijas membrānu BFX un drenāžas noteku

		Iebūvēšanas slīpums			
<b>EDW 1000</b>	Profīlētiem jumta segumiem ar profila augstumu līdz 120 mm	35-53	147,11 <b>178,00</b>	176,03 <b>213,00</b>	163,64 <b>198,00</b>
<b>EDS 1000</b>	Plakaniem jumta segumiem ar augstumu līdz 16 mm (2 x 8 mm)	35-53	147,11 <b>178,00</b>	176,03 <b>213,00</b>	163,64 <b>198,00</b>
<b>EDL 1000</b>	Jumta segumiem ar augstumu līdz 16 mm	35-53	147,11 <b>178,00</b>	176,03 <b>213,00</b>	163,64 <b>198,00</b>

Cenas bez PVN, Euro  
Cenas ar PVN, Euro

Izmērs (cm)

MK19  
78x252

PK19  
94x252

SK19  
114x252

## HIDRO UN SILTUMIZOLĀCIJAS RISINĀJUMS 2000 IETVER DIFŪZIJAS MEMBRĀNU BFX, DRENĀŽAS NOTEKU UN SILTUMIZOLĀCIJAS RĀMI BDX

		Iebūvēšanas slīpums			
<b>EDW 2000</b>	Profīlētiem jumta segumiem ar profila augstumu līdz 120 mm	35-53	171,07 <b>207,00</b>	204,96 <b>248,00</b>	190,08 <b>230,00</b>
<b>EDS 2000</b>	Plakaniem jumta segumiem ar augstumu līdz 16 mm (2 x 8 mm)	35-53	171,07 <b>207,00</b>	204,96 <b>248,00</b>	190,08 <b>230,00</b>
<b>EDL 2000</b>	Jumta segumiem ar augstumu līdz 16 mm	35-53	-	204,96 <b>248,00</b>	-

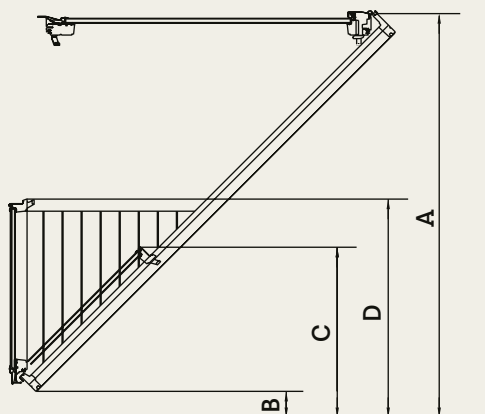

	A	B	C	D
Jumta slīpums	Loga augša	Loga apakša	Augša apakšējam balkona elementam	Margu augstums
	cm	cm	cm	cm
53°	209	0	81	95
50°	201	0	79	95
45°	200	13	88	108
40°	200	28	98	123
35°	200	45	109	140

Jumta slīpuma ietekme uz loga apakšējās malas un loga margas augstumu.



Cenas bez PVN, Euro  
Cenas ar PVN, Euro

M08  
78x140

M35  
78x109

## JUMTA TERASE

		W/(m <sup>2</sup> K)		Iebūvēšanas slīpums	
<b>GEL 2065</b>	Atverams uz āru, priedes koks, apstrādāts ar trīskāršu pārklājumu, balti krāsots, divkameru stikla pakete	1.0	35-53	1 201,65 <b>1 454,00</b>	-
<b>GEL 3065</b>	Atverams uz āru, priedes koks, apstrādāts ar trīskāršu pārklājumu, caurspīdīgs lakojums, divkameru stikla pakete	1.0	35-53	1 201,65 <b>1 454,00</b>	-
<b>VEA 2065</b>	Atverams uz āru pa labi, priedes koks, apstrādāts ar trīskāršu pārklājumu, balti krāsots, divkameru stikla pakete	1.0	35-53	-	1 014,05 <b>1 227,00</b>
<b>VEA 3065</b>	Atverams uz āru pa labi, priedes koks, apstrādāts ar trīskāršu pārklājumu, caurspīdīgs lakojums, divkameru stikla pakete	1.0	35-53	-	1 014,05 <b>1 227,00</b>
<b>VEB 2065</b>	Atverams uz āru pa kreisi, priedes koks, apstrādāts ar trīskāršu pārklājumu, balti krāsots, divkameru stikla pakete	1.0	35-53	-	1 014,05 <b>1 227,00</b>
<b>VEB 3065</b>	Atverams uz āru pa kreisi, priedes koks, apstrādāts ar trīskāršu pārklājumu, caurspīdīgs lakojums, divkameru stikla pakete	1.0	35-53	-	1 014,05 <b>1 227,00</b>
<b>VEC 2065</b>	Neverams, priedes koks, apstrādāts ar trīskāršu pārklājumu, balti krāsots, divkameru stikla pakete	1.0	35-53	-	1 014,05 <b>1 227,00</b>
<b>VEC 3065</b>	Neverams, priedes koks, apstrādāts ar trīskāršu pārklājumu, caurspīdīgs lakojums, divkameru stikla pakete	1.0	35-53	-	1 014,05 <b>1 227,00</b>

GEL ir slīpā jumta logs, kas apvienots ar vertikālu loga elementu VEA/B (atveramu) vai VEC (fiksētu). Apvienojot vairākus logus šādā kombinācijā, atvērt varēs tikai vienu.

Terases izmērs, atkarībā no jumta slīpuma

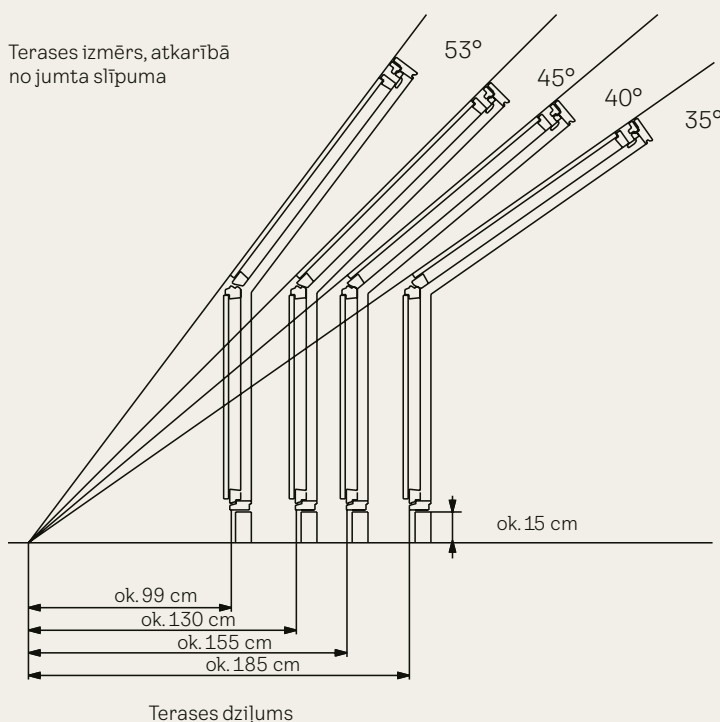

Cenas bez PVN, Euro  
Cenas ar PVN, Euro

Izmērs (cm)

M08  
78x140

M35  
78x109

## JUMTA TERASES KOMBINĀCIJA

### Jumta terases iebūvēšana

		Iebūvēšanas slīpums	
<b>EEW 0000</b>	Profilētiem jumta segumiem ar profila augstumu līdz 120 mm	35-53	157,85 <b>191,00</b>
<b>EES 0000</b>	Plakaniem jumta segumiem ar augstumu līdz 16 mm (2 x 8 mm)	35-53	116,53 <b>141,00</b>
<b>EEX 0000</b>	Vējmalas apdares balsts jumta terasei	35-53	-
			184,30 <b>223,00</b>

Cenas bez PVN, Euro  
Cenas ar PVN, Euro

Izmērs (cm)

M08  
78x140

## KOMBINĒTĀ JUMTA TERASES IEBŪVĒŠANA

		Iebūvēšanas slīpums	
<b>EEW 0001E</b>	Profilētiem jumta segumiem ar profila augstumu līdz 120 mm	35-53	157,85 <b>191,00</b>
<b>EEW 0002E</b>	Profilētiem jumta segumiem ar profila augstumu līdz 120 mm	35-53	157,85 <b>191,00</b>
<b>EEW 0003</b>	Profilētiem jumta segumiem ar profila augstumu līdz 120 mm	35-53	157,85 <b>191,00</b>
<b>EES 0001E</b>	Plakaniem jumta segumiem ar augstumu līdz 16 mm (2 x 8 mm)	35-53	116,53 <b>141,00</b>
<b>EES 0002E</b>	Plakaniem jumta segumiem ar augstumu līdz 16 mm (2 x 8 mm)	35-53	116,53 <b>141,00</b>
<b>EES 0003</b>	Plakaniem jumta segumiem ar augstumu līdz 16 mm (2 x 8 mm)	35-53	116,53 <b>141,00</b>

Nav iespējams blakus uzstādīt divas jumta terases apakšējās daļas ar durvju funkciju. VEA/VEB elementi obligāti jāiebūvē jumta konstrukcijas spārēs.



Cenas bez PVN, Euro  
Cenas ar PVN, Euro

FFKF06  
188x118

FFKF08  
188x140

## JUMTA LOGI TRĪS VIENĀ

		W/(m <sup>2</sup> K) Iebūvēšanas slīpums			
<b>GGLS 2066</b>	Verams ar roku, rokturis augšā, priedes koks, apstrādāts ar trīskāršu pārklājumu, balti krāsots, divkameru stikla pakete	1.0-1.1	15-90	1 374,38 <b>1 663,00</b>	1 607,44 <b>1 945,00</b>
<b>GGLS 206630</b>	Solārs, priedes koks, apstrādāts ar trīskāršu pārklājumu, balti krāsots, divkameru stikla pakete	1.0-1.1	15-90	2 126,45 <b>2 573,00</b>	2 359,50 <b>2 855,00</b>
<b>GGLS 2070</b>	Verams ar roku, rokturis augšā, priedes koks, apstrādāts ar trīskāršu pārklājumu, balti krāsots, vienkameru stikla pakete	1.3-1.4	15-90	981,82 <b>1 188,00</b>	1 147,93 <b>1 389,00</b>
<b>GGLS 207030</b>	Solārs, priedes koks, apstrādāts ar trīskāršu pārklājumu, balti krāsots, vienkameru stikla pakete	1.3-1.4	15-90	1 733,88 <b>2 098,00</b>	1 900,00 <b>2 299,00</b>
<b>GPLS 2066</b>	Verams ar roku, rokturis apakšā, pa augšējo asi verams, priedes koks, apstrādāts ar trīskāršu pārklājumu, balti krāsots, divkameru stikla pakete	1.1-1.2	15-55	1 774,38 <b>2 147,00</b>	2 007,44 <b>2 429,00</b>
<b>GPLS 2070</b>	Verams ar roku, rokturis apakšā, pa augšējo asi verams, priedes koks, apstrādāts ar trīskāršu pārklājumu, balti krāsots, vienkameru stikla pakete	1.3-1.4	15-55	1 381,82 <b>1 672,00</b>	1 547,93 <b>1 873,00</b>

EDWS un EDLS pieslēgumos ietilpst arī izolācijas rāmis BDX un difūzijas membrāna BFX.

Cenas bez PVN, Euro  
Cenas ar PVN, Euro

FFKF06  
188x118

FFKF08  
188x140

## PIESLĒGUMS AR BDX JUMTA LOGIEM TRĪS VIENĀ

		Iebūvēšanas slīpums			
<b>EDWS 2000</b>		15-90		1 214,63 <b>1 494,00</b>	1 291,87 <b>1 589,00</b>
<b>EDLS 2000</b>		15-90		1 214,63 <b>1 494,00</b>	1 291,87 <b>1 589,00</b>

EDWS un EDLS pieslēgumos ietilpst arī izolācijas rāmis BDX un difūzijas membrāna BFX.

# PRODUKTU KOMPLEKTI

Cenas bez PVN, Euro  
Cenas ar PVN, Euro

  
2 x CK04  
2 x 55x98

  
2 x FK06  
2 x 66x118

  
2 x FK08  
2 x 66x140

  
2 x MK04  
2 x 78x98









  
2 x MK06  
2 x 78x118

  
2 x MK08  
2 x 78x140

  
2 x MK10  
2 x 78x160

  
2 x PK08  
2 x 94x140







KOMBINĒTIE RISINĀJUMI									
2 x GLL 1061B + EKS 2021M	GLL S10S84	783,47 <b>948,00</b>	910,74 <b>1 102,00</b>	993,39 <b>1 202,00</b>	895,87 <b>1 084,00</b>	970,25 <b>1 174,00</b>	1 041,32 <b>1 260,00</b>	1 200,00 <b>1 452,00</b>	1 214,88 <b>1 470,00</b>
2 x GLL 1061 + EKS 2021M	GLL S10S85	783,47 <b>948,00</b>	910,74 <b>1 102,00</b>	993,39 <b>1 202,00</b>	895,87 <b>1 084,00</b>	970,25 <b>1 174,00</b>	1 041,32 <b>1 260,00</b>	1 200,00 <b>1 452,00</b>	1 214,88 <b>1 470,00</b>
2 x GLL 1064B + EKS 2021M	GLL S10S86	935,54 <b>1 132,00</b>	1 087,60 <b>1 316,00</b>	1 186,78 <b>1 436,00</b>	1 067,77 <b>1 292,00</b>	1 158,68 <b>1 402,00</b>	1 242,98 <b>1 504,00</b>	1 433,06 <b>1 734,00</b>	1 449,59 <b>1 754,00</b>
2 x GLL 1064 + EKS 2021M	GLL S10S87	935,54 <b>1 132,00</b>	1 087,60 <b>1 316,00</b>	1 186,78 <b>1 436,00</b>	1 067,77 <b>1 292,00</b>	1 158,68 <b>1 402,00</b>	1 242,98 <b>1 504,00</b>	1 433,06 <b>1 734,00</b>	1 449,59 <b>1 754,00</b>
2 x GLL 1061 + EKT 0003 + EKT 0001E	GLL S10T07	709,09 <b>858,00</b>	828,10 <b>1 002,00</b>	905,79 <b>1 096,00</b>	813,22 <b>984,00</b>	882,64 <b>1 068,00</b>	947,11 <b>1 146,00</b>	1 097,52 <b>1 328,00</b>	1 109,09 <b>1 342,00</b>
2 x GLL 1064 + EKT 0003 + EKT 0001E	GLL S10T08	861,16 <b>1 042,00</b>	1 004,96 <b>1 216,00</b>	1 099,17 <b>1 330,00</b>	985,12 <b>1 192,00</b>	1 071,07 <b>1 296,00</b>	1 148,76 <b>1 390,00</b>	1 330,58 <b>1 610,00</b>	1 343,80 <b>1 626,00</b>
2 x GLL 1061 + EKT 0003 + EKT 0001F	GLL S10T09	709,09 <b>858,00</b>	828,10 <b>1 002,00</b>	905,79 <b>1 096,00</b>	813,22 <b>984,00</b>	882,64 <b>1 068,00</b>	947,11 <b>1 146,00</b>	1 097,52 <b>1 328,00</b>	1 109,09 <b>1 342,00</b>
2 x GLL 1064 + EKT 0003 + EKT 0001F	GLL S10T10	861,16 <b>1 042,00</b>	1 004,96 <b>1 216,00</b>	1 099,17 <b>1 330,00</b>	985,12 <b>1 192,00</b>	1 071,07 <b>1 296,00</b>	1 148,76 <b>1 390,00</b>	1 330,58 <b>1 610,00</b>	1 343,80 <b>1 626,00</b>
2 x GLL 1061 + EKT 0003 + EKT 0001G	GLL S10T11	709,09 <b>858,00</b>	828,10 <b>1 002,00</b>	905,79 <b>1 096,00</b>	813,22 <b>984,00</b>	882,64 <b>1 068,00</b>	947,11 <b>1 146,00</b>	1 097,52 <b>1 328,00</b>	1 109,09 <b>1 342,00</b>
2 x GLL 1064 + EKT 0003 + EKT 0001G	GLL S10T12	861,16 <b>1 042,00</b>	1 004,96 <b>1 216,00</b>	1 099,17 <b>1 330,00</b>	985,12 <b>1 192,00</b>	1 071,07 <b>1 296,00</b>	1 148,76 <b>1 390,00</b>	1 330,58 <b>1 610,00</b>	1 343,80 <b>1 626,00</b>
2 x GLL 1061 + EKT 0003 + EKT 0001H	GLL S10T13	709,09 <b>858,00</b>	828,10 <b>1 002,00</b>	905,79 <b>1 096,00</b>	813,22 <b>984,00</b>	882,64 <b>1 068,00</b>	947,11 <b>1 146,00</b>	1 097,52 <b>1 328,00</b>	1 109,09 <b>1 342,00</b>
2 x GLL 1064B + EKT 0003 + EKT 0001E	GLL S10T15	861,16 <b>1 042,00</b>	1 004,96 <b>1 216,00</b>	1 099,17 <b>1 330,00</b>	985,12 <b>1 192,00</b>	1 071,07 <b>1 296,00</b>	1 148,76 <b>1 390,00</b>	1 330,58 <b>1 610,00</b>	1 343,80 <b>1 626,00</b>
2 x GLL 1064B + EKT 0003 + EKT 0001F	GLL S10T16	861,16 <b>1 042,00</b>	1 004,96 <b>1 216,00</b>	1 099,17 <b>1 330,00</b>	985,12 <b>1 192,00</b>	1 071,07 <b>1 296,00</b>	1 148,76 <b>1 390,00</b>	1 330,58 <b>1 610,00</b>	1 343,80 <b>1 626,00</b>
2 x GLL 1064B + EKT 0003 + EKT 0001G	GLL S10T17	861,16 <b>1 042,00</b>	1 004,96 <b>1 216,00</b>	1 099,17 <b>1 330,00</b>	985,12 <b>1 192,00</b>	1 071,07 <b>1 296,00</b>	1 148,76 <b>1 390,00</b>	1 330,58 <b>1 610,00</b>	1 343,80 <b>1 626,00</b>
2 x GLL 1064B + EKT 0003 + EKT 0001H	GLL S10T18	861,16 <b>1 042,00</b>	1 004,96 <b>1 216,00</b>	1 099,17 <b>1 330,00</b>	985,12 <b>1 192,00</b>	1 071,07 <b>1 296,00</b>	1 148,76 <b>1 390,00</b>	1 330,58 <b>1 610,00</b>	1 343,80 <b>1 626,00</b>
2 x GLL 1064 + EKT 0003 + EKT 0001H	GLL S10T19	861,16 <b>1 042,00</b>	1 004,96 <b>1 216,00</b>	1 099,17 <b>1 330,00</b>	985,12 <b>1 192,00</b>	1 071,07 <b>1 296,00</b>	1 148,76 <b>1 390,00</b>	1 330,58 <b>1 610,00</b>	1 343,80 <b>1 626,00</b>
2 x GLL 1061B + EKT 0003 + EKT 0001H	GLL S10T21	709,09 <b>858,00</b>	828,10 <b>1 002,00</b>	905,79 <b>1 096,00</b>	813,22 <b>984,00</b>	882,64 <b>1 068,00</b>	947,11 <b>1 146,00</b>	1 097,52 <b>1 328,00</b>	1 109,09 <b>1 342,00</b>
2 x GLL 1061B + EKW 2021M	GLL S10W75	783,47 <b>948,00</b>	910,74 <b>1 102,00</b>	993,39 <b>1 202,00</b>	895,87 <b>1 084,00</b>	970,25 <b>1 174,00</b>	1 041,32 <b>1 260,00</b>	1 200,00 <b>1 452,00</b>	1 214,88 <b>1 470,00</b>
2 x GLL 1061 + EKW 2021M	GLL S10W76	783,47 <b>948,00</b>	910,74 <b>1 102,00</b>	993,39 <b>1 202,00</b>	895,87 <b>1 084,00</b>	970,25 <b>1 174,00</b>	1 041,32 <b>1 260,00</b>	1 200,00 <b>1 452,00</b>	1 214,88 <b>1 470,00</b>
2 x GLL 1064B + EKW 2021M	GLL S10W77	935,54 <b>1 132,00</b>	1 087,60 <b>1 316,00</b>	1 186,78 <b>1 436,00</b>	1 067,77 <b>1 292,00</b>	1 158,68 <b>1 402,00</b>	1 242,98 <b>1 504,00</b>	1 433,06 <b>1 734,00</b>	1 449,59 <b>1 754,00</b>
2 x GLL 1064 + EKW 2021M	GLL S10W78	935,54 <b>1 132,00</b>	1 087,60 <b>1 316,00</b>	1 186,78 <b>1 436,00</b>	1 067,77 <b>1 292,00</b>	1 158,68 <b>1 402,00</b>	1 242,98 <b>1 504,00</b>	1 433,06 <b>1 734,00</b>	1 449,59 <b>1 754,00</b>
2 x GLU 0061B + EKS 2021M	GLU S10S80	935,54 <b>1 132,00</b>	1 087,60 <b>1 316,00</b>	1 186,78 <b>1 436,00</b>	1 067,77 <b>1 292,00</b>	1 158,68 <b>1 402,00</b>	1 242,98 <b>1 504,00</b>	1 433,06 <b>1 734,00</b>	1 449,59 <b>1 754,00</b>
2 x GLU 0061 + EKS 2021M	GLU S10S81	935,54 <b>1 132,00</b>	1 087,60 <b>1 316,00</b>	1 186,78 <b>1 436,00</b>	1 067,77 <b>1 292,00</b>	1 158,68 <b>1 402,00</b>	1 242,98 <b>1 504,00</b>	1 433,06 <b>1 734,00</b>	1 449,59 <b>1 754,00</b>
2 x GLU 0064B + EKS 2021M	GLU S10S82	1 123,97 <b>1 360,00</b>	1 305,79 <b>1 580,00</b>	1 426,45 <b>1 726,00</b>	1 282,64 <b>1 552,00</b>	1 391,74 <b>1 684,00</b>	1 490,91 <b>1 804,00</b>	1 722,31 <b>2 084,00</b>	1 740,50 <b>2 106,00</b>
2 x GLU 0064 + EKS 2021M	GLU S10S83	1 123,97 <b>1 360,00</b>	1 305,79 <b>1 580,00</b>	1 426,45 <b>1 726,00</b>	1 282,64 <b>1 552,00</b>	1 391,74 <b>1 684,00</b>	1 490,91 <b>1 804,00</b>	1 722,31 <b>2 084,00</b>	1 740,50 <b>2 106,00</b>
2 x GLU 0061 + EKT 0003 + EKT 0001E	GLU S10T07	861,16 <b>1 042,00</b>	1 004,96 <b>1 216,00</b>	1 099,17 <b>1 330,00</b>	985,12 <b>1 192,00</b>	1 071,07 <b>1 296,00</b>	1 148,76 <b>1 390,00</b>	1 330,58 <b>1 610,00</b>	1 343,80 <b>1 626,00</b>
2 x GLU 0064 + EKT 0003 + EKT 0001E	GLU S10T08	1 049,59 <b>1 270,00</b>	1 223,14 <b>1 480,00</b>	1 338,84 <b>1 620,00</b>	1 200,00 <b>1 452,00</b>	1 304,13 <b>1 578,00</b>	1 396,69 <b>1 690,00</b>	1 619,83 <b>1 960,00</b>	1 634,71 <b>1 978,00</b>

 2 x CK04 2 x 55x98	 2 x FK06 2 x 66x118	 2 x FK08 2 x 66x140	 2 x MK04 2 x 78x98	 2 x MK06 2 x 78x118	 2 x MK08 2 x 78x140	 2 x MK10 2 x 78x160	 2 x PK08 2 x 94x140
--	---	---	--	---	---	---	---

<b>KOMBINĒTIE RISINĀJUMI</b>									
2 x GLU 0061 + EKT 0003 + EKT 0001F	GLU S10T09	861,16 <b>1 042,00</b>	1 004,96 <b>1 216,00</b>	1 099,17 <b>1 330,00</b>	985,12 <b>1 192,00</b>	1 071,07 <b>1 296,00</b>	1 148,76 <b>1 390,00</b>	1 330,58 <b>1 610,00</b>	1 343,80 <b>1 626,00</b>
2 x GLU 0064 + EKT 0003 + EKT 0001F	GLU S10T10	1 049,59 <b>1 270,00</b>	1 223,14 <b>1 480,00</b>	1 338,84 <b>1 620,00</b>	1 200,00 <b>1 452,00</b>	1 304,13 <b>1 578,00</b>	1 396,69 <b>1 690,00</b>	1 619,83 <b>1 960,00</b>	1 634,71 <b>1 978,00</b>
2 x GLU 0061 + EKT 0003 + EKT 0001G	GLU S10T11	861,16 <b>1 042,00</b>	1 004,96 <b>1 216,00</b>	1 099,17 <b>1 330,00</b>	985,12 <b>1 192,00</b>	1 071,07 <b>1 296,00</b>	1 148,76 <b>1 390,00</b>	1 330,58 <b>1 610,00</b>	1 343,80 <b>1 626,00</b>
2 x GLU 0064 + EKT 0003 + EKT 0001G	GLU S10T12	1 049,59 <b>1 270,00</b>	1 223,14 <b>1 480,00</b>	1 338,84 <b>1 620,00</b>	1 200,00 <b>1 452,00</b>	1 304,13 <b>1 578,00</b>	1 396,69 <b>1 690,00</b>	1 619,83 <b>1 960,00</b>	1 634,71 <b>1 978,00</b>
2 x GLU 0061 + EKT 0003 + EKT 0001H	GLU S10T13	861,16 <b>1 042,00</b>	1 004,96 <b>1 216,00</b>	1 099,17 <b>1 330,00</b>	985,12 <b>1 192,00</b>	1 071,07 <b>1 296,00</b>	1 148,76 <b>1 390,00</b>	1 330,58 <b>1 610,00</b>	1 343,80 <b>1 626,00</b>
2 x GLU 0064B + EKT 0003 + EKT 0001E	GLU S10T15	1 049,59 <b>1 270,00</b>	1 223,14 <b>1 480,00</b>	1 338,84 <b>1 620,00</b>	1 200,00 <b>1 452,00</b>	1 304,13 <b>1 578,00</b>	1 396,69 <b>1 690,00</b>	1 619,83 <b>1 960,00</b>	1 634,71 <b>1 978,00</b>
2 x GLU 0064B + EKT 0003 + EKT 0001F	GLU S10T16	1 049,59 <b>1 270,00</b>	1 223,14 <b>1 480,00</b>	1 338,84 <b>1 620,00</b>	1 200,00 <b>1 452,00</b>	1 304,13 <b>1 578,00</b>	1 396,69 <b>1 690,00</b>	1 619,83 <b>1 960,00</b>	1 634,71 <b>1 978,00</b>
2 x GLU 0064B + EKT 0003 + EKT 0001G	GLU S10T17	1 049,59 <b>1 270,00</b>	1 223,14 <b>1 480,00</b>	1 338,84 <b>1 620,00</b>	1 200,00 <b>1 452,00</b>	1 304,13 <b>1 578,00</b>	1 396,69 <b>1 690,00</b>	1 619,83 <b>1 960,00</b>	1 634,71 <b>1 978,00</b>
2 x GLU 0064B + EKT 0003 + EKT 0001H	GLU S10T18	1 049,59 <b>1 270,00</b>	1 223,14 <b>1 480,00</b>	1 338,84 <b>1 620,00</b>	1 200,00 <b>1 452,00</b>	1 304,13 <b>1 578,00</b>	1 396,69 <b>1 690,00</b>	1 619,83 <b>1 960,00</b>	1 634,71 <b>1 978,00</b>
2 x GLU 0064 + EKT 0003 + EKT 0001H	GLU S10T20	1 049,59 <b>1 270,00</b>	1 223,14 <b>1 480,00</b>	1 338,84 <b>1 620,00</b>	1 200,00 <b>1 452,00</b>	1 304,13 <b>1 578,00</b>	1 396,69 <b>1 690,00</b>	1 619,83 <b>1 960,00</b>	1 634,71 <b>1 978,00</b>
2 x GLU 0061B + EKW 2021M	GLU S10W71	935,54 <b>1 132,00</b>	1 087,60 <b>1 316,00</b>	1 186,78 <b>1 436,00</b>	1 067,77 <b>1 292,00</b>	1 158,68 <b>1 402,00</b>	1 242,98 <b>1 504,00</b>	1 433,06 <b>1 734,00</b>	1 449,59 <b>1 754,00</b>
2 x GLU 0061 + EKW 2021M	GLU S10W72	935,54 <b>1 132,00</b>	1 087,60 <b>1 316,00</b>	1 186,78 <b>1 436,00</b>	1 067,77 <b>1 292,00</b>	1 158,68 <b>1 402,00</b>	1 242,98 <b>1 504,00</b>	1 433,06 <b>1 734,00</b>	1 449,59 <b>1 754,00</b>
2 x GLU 0064B + EKW 2021M	GLU S10W73	1 123,97 <b>1 360,00</b>	1 305,79 <b>1 580,00</b>	1 426,45 <b>1 726,00</b>	1 282,64 <b>1 552,00</b>	1 391,74 <b>1 684,00</b>	1 490,91 <b>1 804,00</b>	1 722,31 <b>2 084,00</b>	1 740,50 <b>2 106,00</b>
2 x GLU 0064 + EKW 2021M	GLU S10W74	1 123,97 <b>1 360,00</b>	1 305,79 <b>1 580,00</b>	1 426,45 <b>1 726,00</b>	1 282,64 <b>1 552,00</b>	1 391,74 <b>1 684,00</b>	1 490,91 <b>1 804,00</b>	1 722,31 <b>2 084,00</b>	1 740,50 <b>2 106,00</b>
2 x GLL 1061B + EKT 0003 + EKT 0001E	GLL S10T02	709,09 <b>858,00</b>	828,10 <b>1 002,00</b>	905,79 <b>1 096,00</b>	813,22 <b>984,00</b>	882,64 <b>1 068,00</b>	947,11 <b>1 146,00</b>	1 097,52 <b>1 328,00</b>	1 109,09 <b>1 342,00</b>
2 x GLL 1061B + EKT 0003 + EKT 0001F	GLL S10T04	709,09 <b>858,00</b>	828,10 <b>1 002,00</b>	905,79 <b>1 096,00</b>	813,22 <b>984,00</b>	882,64 <b>1 068,00</b>	947,11 <b>1 146,00</b>	1 097,52 <b>1 328,00</b>	1 109,09 <b>1 342,00</b>
2 x GLL 1061B + EKT 0003 + EKT 0001G	GLL S10T06	709,09 <b>858,00</b>	828,10 <b>1 002,00</b>	905,79 <b>1 096,00</b>	813,22 <b>984,00</b>	882,64 <b>1 068,00</b>	947,11 <b>1 146,00</b>	1 097,52 <b>1 328,00</b>	1 109,09 <b>1 342,00</b>
2 x GLU 0061B + EKT 0003 + EKT 0001E	GLU S10T02	861,16 <b>1 042,00</b>	1 004,96 <b>1 216,00</b>	1 099,17 <b>1 330,00</b>	985,12 <b>1 192,00</b>	1 071,07 <b>1 296,00</b>	1 148,76 <b>1 390,00</b>	1 330,58 <b>1 610,00</b>	1 343,80 <b>1 626,00</b>
2 x GLU 0061B + EKT 0003 + EKT 0001F	GLU S10T04	861,16 <b>1 042,00</b>	1 004,96 <b>1 216,00</b>	1 099,17 <b>1 330,00</b>	985,12 <b>1 192,00</b>	1 071,07 <b>1 296,00</b>	1 148,76 <b>1 390,00</b>	1 330,58 <b>1 610,00</b>	1 343,80 <b>1 626,00</b>
2 x GLU 0061B + EKT 0003 + EKT 0001G	GLU S10T06	861,16 <b>1 042,00</b>	1 004,96 <b>1 216,00</b>	1 099,17 <b>1 330,00</b>	985,12 <b>1 192,00</b>	1 071,07 <b>1 296,00</b>	1 148,76 <b>1 390,00</b>	1 330,58 <b>1 610,00</b>	1 343,80 <b>1 626,00</b>
2 x GLU 0061B + EKT 0003 + EKT 0001H	GLU S10T21	861,16 <b>1 042,00</b>	1 004,96 <b>1 216,00</b>	1 099,17 <b>1 330,00</b>	985,12 <b>1 192,00</b>	1 071,07 <b>1 296,00</b>	1 148,76 <b>1 390,00</b>	1 330,58 <b>1 610,00</b>	1 343,80 <b>1 626,00</b>

Izdevīgāka  
cena,  
iegādājoties  
komplektā

Cenas bez PVN, Euro  
Cenas ar PVN, Euro

					
<b>MK06 + MK31</b> 78x118 + 78x60	<b>MK06 + MK35</b> 78x118 + 78x95	<b>MK08 + MK31</b> 78x140 + 78x60	<b>MK08 + MK35</b> 78x140 + 78x95	<b>MK10 + MK31</b> 78x160 + 78x60	<b>MK10 + MK35</b> 78x160 + 78x95

### KOMBINĒTAIS RISINĀJUMS AR VERTIKĀLAJEM LOGA ELEMENTIEM

VFE 3068 + GLL 1061B	GLL S10003	845,45 <b>1 023,00</b>	-	871,90 <b>1 055,00</b>	-	935,54 <b>1 132,00</b>	-
VFE 3068 + GLL 1061B	GLL S10004	-	912,40 <b>1 104,00</b>	-	938,84 <b>1 136,00</b>	-	1 002,48 <b>1 213,00</b>
VFE 3068 + GLL 1064B	GLL S10007	939,67 <b>1 137,00</b>	-	972,73 <b>1 177,00</b>	-	1 052,07 <b>1 273,00</b>	-
VFE 3068 + GLL 1064B	GLL S10008	-	1 006,61 <b>1 218,00</b>	-	1 039,67 <b>1 258,00</b>	-	1 119,01 <b>1 354,00</b>
VFE 3068 + GLL 1061	GLL S10009	845,45 <b>1 023,00</b>	-	871,90 <b>1 055,00</b>	-	935,54 <b>1 132,00</b>	-
VFE 3068 + GLL 1064	GLL S10010	939,67 <b>1 137,00</b>	-	972,73 <b>1 177,00</b>	-	1 052,07 <b>1 273,00</b>	-
VFE 3068 + GLL 1061	GLL S10011	-	912,40 <b>1 104,00</b>	-	938,84 <b>1 136,00</b>	-	1 002,48 <b>1 213,00</b>
VFE 3068 + GLL 1064	GLL S10012	-	1 006,61 <b>1 218,00</b>	-	1 039,67 <b>1 258,00</b>	-	1 119,01 <b>1 354,00</b>

Izmērs (cm)	CK02 55x78	CK04 55x98	CK06 55x118	FK04 66x98	FK06 66x118	FK08 66x140	MK04 78x98	MK06 78x118
-------------	---------------	---------------	----------------	---------------	----------------	----------------	---------------	----------------

### PAMATA PIESLĒGUMA KOMPLEKTS AR HIDRO UN SILTUMIZOLĀCIJU

EDJ 2000 + BBX 0000	EDJ S00J01	164,46 <b>199,00</b>	168,60 <b>204,00</b>	173,55 <b>210,00</b>	173,55 <b>210,00</b>	185,95 <b>225,00</b>	194,21 <b>235,00</b>	185,95 <b>225,00</b>	194,21 <b>235,00</b>
EDS 2000 + BBX 0000	EDS S00S01	140,50 <b>170,00</b>	142,98 <b>173,00</b>	147,93 <b>179,00</b>	147,93 <b>179,00</b>	157,85 <b>191,00</b>	165,29 <b>200,00</b>	157,85 <b>191,00</b>	165,29 <b>200,00</b>
EDT 2000 + BBX 0000	EDT S00T01	140,50 <b>170,00</b>	142,98 <b>173,00</b>	147,93 <b>179,00</b>	147,93 <b>179,00</b>	157,85 <b>191,00</b>	165,29 <b>200,00</b>	157,85 <b>191,00</b>	165,29 <b>200,00</b>
EDW 2000 + BBX 0000	EDW S00W01	140,50 <b>170,00</b>	142,98 <b>173,00</b>	147,93 <b>179,00</b>	147,93 <b>179,00</b>	157,85 <b>191,00</b>	165,29 <b>200,00</b>	157,85 <b>191,00</b>	165,29 <b>200,00</b>
EDZ 2000 + BBX 0000	EDZ S00Z01	147,93 <b>179,00</b>	149,59 <b>181,00</b>	152,07 <b>184,00</b>	152,07 <b>184,00</b>	154,55 <b>187,00</b>	157,02 <b>190,00</b>	152,89 <b>185,00</b>	157,02 <b>190,00</b>
EDQ 2000 + BBX 0000	EDQ ++	-	173,55 <b>210,00</b>	-	-	-	184,30 <b>223,00</b>	180,17 <b>218,00</b>	-

VELUX pieslēguma komplekti ir izstrādāti tā, lai VELUX jumta logi lieliski integrētos jumta segumā. Tie nodrošina pilnīgu aizsardzību no ārpuses un iekšpuses jebkuros laikapstākļos. Komplekts sastāv no pieslēguma, siltumizolācijas rāmja BDx, hidroizolācijas membrānas BFX un tvaika barjeras BBX.

PK08 + PK35  
94x140 + 94x95

Izdevīgāka  
cena,  
iegādājoties  
komplektā

-
1 085,95 <b>1 314,00</b>
-
1 203,31 <b>1 456,00</b>
1 085,95 <b>1 314,00</b>
1 203,31 <b>1 456,00</b>
-
-

Izdevīgāka  
cena,  
iegādājoties  
komplektā

MK08 78x140	MK10 78x160	PK06 94x118	PK08 94x140	PK10 94x160	SK06 114x118	SK08 114x140	SK10 114x160	UK04 134x98	UK08 134x140	UK10 134x160
204,96 <b>248,00</b>	224,79 <b>272,00</b>	217,36 <b>263,00</b>	228,10 <b>276,00</b>	234,71 <b>284,00</b>	226,45 <b>274,00</b>	238,84 <b>289,00</b>	247,11 <b>299,00</b>	-	256,20 <b>310,00</b>	282,64 <b>342,00</b>
174,38 <b>211,00</b>	190,08 <b>230,00</b>	184,30 <b>223,00</b>	193,39 <b>234,00</b>	199,17 <b>241,00</b>	191,74 <b>232,00</b>	201,65 <b>244,00</b>	209,09 <b>253,00</b>	201,65 <b>244,00</b>	216,53 <b>262,00</b>	238,84 <b>289,00</b>
174,38 <b>211,00</b>	190,08 <b>230,00</b>	184,30 <b>223,00</b>	193,39 <b>234,00</b>	199,17 <b>241,00</b>	191,74 <b>232,00</b>	201,65 <b>244,00</b>	209,09 <b>253,00</b>	201,65 <b>244,00</b>	216,53 <b>262,00</b>	238,84 <b>289,00</b>
174,38 <b>211,00</b>	190,08 <b>230,00</b>	184,30 <b>223,00</b>	193,39 <b>234,00</b>	199,17 <b>241,00</b>	191,74 <b>232,00</b>	201,65 <b>244,00</b>	209,09 <b>253,00</b>	201,65 <b>244,00</b>	216,53 <b>262,00</b>	238,84 <b>289,00</b>
162,81 <b>197,00</b>	172,73 <b>209,00</b>	168,60 <b>204,00</b>	174,38 <b>211,00</b>	178,51 <b>216,00</b>	173,55 <b>210,00</b>	180,17 <b>218,00</b>	184,30 <b>223,00</b>	180,17 <b>218,00</b>	189,26 <b>229,00</b>	202,48 <b>245,00</b>
-	-	-	206,61 <b>250,00</b>	-	205,79 <b>249,00</b>	214,88 <b>260,00</b>	-	-	226,45 <b>274,00</b>	-

# IEBŪVĒŠANAS PIEDERUMI

Cenas bez PVN, Euro  
Cenas ar PVN, Euro

Izmērs (cm)

CK02  
55x78

CK04  
55x98

CK06  
55x118

FK04  
66x98

FK06  
66x118

FK08  
66x140

MK04  
78x98

MK06  
78x118

## IEBŪVĒŠANAS PIEDERUMI

### Pieslēguma komplekts ar BDX, BFX un drenāžas noteku (BDX WK34 neietilpst drenāžas noteka)

<b>BDX 2000</b>	Hidro un siltumizolācijas komplekts viena jumta loga iebūvēšanai	42,15 <b>51,00</b>	44,63 <b>54,00</b>	46,28 <b>56,00</b>	45,45 <b>55,00</b>	48,76 <b>59,00</b>	50,41 <b>61,00</b>	48,76 <b>59,00</b>	50,41 <b>61,00</b>
<b>BDX 2000F</b>	Hidro un siltumizolācijas komplekts viena jumta loga padziļinātai iebūvēšanai	48,76 <b>59,00</b>	51,24 <b>62,00</b>	53,72 <b>65,00</b>	52,07 <b>63,00</b>	55,37 <b>67,00</b>	57,85 <b>70,00</b>	55,37 <b>67,00</b>	57,85 <b>70,00</b>
<b>BDX 2011</b>	VELUX iebūvēšanas komplekts atbalsta spārei EBĻ	83,47 <b>101,00</b>	87,60 <b>106,00</b>	91,74 <b>111,00</b>	90,08 <b>109,00</b>	95,87 <b>116,00</b>	100,00 <b>121,00</b>	95,87 <b>116,00</b>	100,00 <b>121,00</b>
<b>BDX 2011E</b>	VELUX iebūvēšanas komplekts atbalsta spārei EKY	88,43 <b>107,00</b>	92,56 <b>112,00</b>	96,69 <b>117,00</b>	94,21 <b>114,00</b>	100,83 <b>122,00</b>	104,96 <b>127,00</b>	100,83 <b>122,00</b>	104,96 <b>127,00</b>
<b>BDX 4021B</b>	Iebūvēšanas komplekts 2in1 logu iebūvēšanai	170,25 <b>206,00</b>	174,38 <b>211,00</b>	180,17 <b>218,00</b>	180,17 <b>218,00</b>	194,21 <b>235,00</b>	204,96 <b>248,00</b>	194,21 <b>235,00</b>	204,96 <b>248,00</b>
<b>BDX 4021E</b>	Iebūvēšanas komplekts kombinētai jumta logu iebūvēšanai viens blakus otram	181,82 <b>220,00</b>	186,78 <b>226,00</b>	193,39 <b>234,00</b>	193,39 <b>234,00</b>	208,26 <b>252,00</b>	219,83 <b>266,00</b>	208,26 <b>252,00</b>	219,83 <b>266,00</b>
<b>BDX 4021EF</b>	Iebūvēšanas komplekts kombinētai jumta logu iebūvēšanai viens blakus otram	181,82 <b>220,00</b>	186,78 <b>226,00</b>	193,39 <b>234,00</b>	193,39 <b>234,00</b>	208,26 <b>252,00</b>	219,83 <b>266,00</b>	208,26 <b>252,00</b>	219,83 <b>266,00</b>
<b>BDX 4031B</b>	Iebūvēšanas komplekts kombinētai jumta logu iebūvēšanai viens blakus otram	289,26 <b>350,00</b>	295,87 <b>358,00</b>	306,61 <b>371,00</b>	306,61 <b>371,00</b>	330,58 <b>400,00</b>	347,93 <b>421,00</b>	330,58 <b>400,00</b>	347,93 <b>421,00</b>













### Komplekts nodrošina hermētisku jumta loga savienojumu ar jumta konstrukciju









<b>BFX 1000</b>	Hidroizolācijas membrāna viena loga iebūvēšanai	22,31 <b>27,00</b>	23,14 <b>28,00</b>	23,97 <b>29,00</b>	23,97 <b>29,00</b>	24,79 <b>30,00</b>	26,45 <b>32,00</b>	24,79 <b>30,00</b>	26,45 <b>32,00</b>
<b>BFX 1000F</b>	Hidroizolācijas membrāna viena loga padziļinātai iebūvēšanai	23,14 <b>28,00</b>	23,97 <b>29,00</b>	24,79 <b>30,00</b>	24,79 <b>30,00</b>	26,45 <b>32,00</b>	27,27 <b>33,00</b>	26,45 <b>32,00</b>	27,27 <b>33,00</b>
<b>BFX 1000U</b>	Hidroizolācijas membrāna viena loga iebūvēšanai betona jumtā	-	-	-	-	-	-	-	-

### Tvaika barjera palīdz novērst mitruma nokļūšanu jumta konstrukcijā. Palīdz hermētiski savienot jumta logu ar esošo tvaika barjeru

<b>BBX 0021B</b>	Tvaika barjera logiem, kas iebūvēti risinājumā viens blakus otram	76,03 <b>92,00</b>	77,69 <b>94,00</b>	79,34 <b>96,00</b>	79,34 <b>96,00</b>	80,99 <b>98,00</b>	84,30 <b>102,00</b>	80,99 <b>98,00</b>	82,64 <b>100,00</b>
<b>BBX 0021E</b>	Tvaika barjera logiem, kas iebūvēti risinājumā viens blakus otram	76,03 <b>92,00</b>	77,69 <b>94,00</b>	79,34 <b>96,00</b>	79,34 <b>96,00</b>	80,99 <b>98,00</b>	84,30 <b>102,00</b>	80,99 <b>98,00</b>	82,64 <b>100,00</b>
<b>BBX 0000</b>	Tvaika barjera	-	25,62 <b>31,00</b>	25,62 <b>31,00</b>	25,62 <b>31,00</b>	25,62 <b>31,00</b>	25,62 <b>31,00</b>	25,62 <b>31,00</b>	25,62 <b>31,00</b>



	 MK08 78x140	 MK10 78x160	 MK12 78x180	 PK06 94x118	 PK08 94x140	 PK10 94x160	 SK06 114x118	 SK08 114x140	 SK10 114x160	 UK04 134x98	 UK08 134x140	 UK10 134x160
	52,89 <b>64,00</b>	54,55 <b>66,00</b>	59,50 <b>72,00</b>	52,89 <b>64,00</b>	54,55 <b>66,00</b>	57,02 <b>69,00</b>	54,55 <b>66,00</b>	57,02 <b>69,00</b>	60,33 <b>73,00</b>	54,55 <b>66,00</b>	59,50 <b>72,00</b>	61,16 <b>74,00</b>
	61,16 <b>74,00</b>	62,81 <b>76,00</b>	68,60 <b>83,00</b>	61,16 <b>74,00</b>	62,81 <b>76,00</b>	65,29 <b>79,00</b>	62,81 <b>76,00</b>	65,29 <b>79,00</b>	68,60 <b>83,00</b>	62,81 <b>76,00</b>	68,60 <b>83,00</b>	71,07 <b>86,00</b>
	104,96 <b>127,00</b>	107,44 <b>130,00</b>	118,18 <b>143,00</b>	104,96 <b>127,00</b>	107,44 <b>130,00</b>	112,40 <b>136,00</b>	109,09 <b>132,00</b>	112,40 <b>136,00</b>	119,01 <b>144,00</b>	109,09 <b>132,00</b>	118,18 <b>143,00</b>	121,49 <b>147,00</b>
	109,92 <b>133,00</b>	113,22 <b>137,00</b>	123,97 <b>150,00</b>	109,92 <b>133,00</b>	113,22 <b>137,00</b>	118,18 <b>143,00</b>	114,05 <b>138,00</b>	118,18 <b>143,00</b>	124,79 <b>151,00</b>	114,05 <b>138,00</b>	123,97 <b>150,00</b>	128,10 <b>155,00</b>
	217,36 <b>263,00</b>	239,67 <b>290,00</b>	243,80 <b>295,00</b>	231,40 <b>280,00</b>	243,80 <b>295,00</b>	252,07 <b>305,00</b>	241,32 <b>292,00</b>	256,20 <b>310,00</b>	266,12 <b>322,00</b>	256,20 <b>310,00</b>	276,86 <b>335,00</b>	-
	232,23 <b>281,00</b>	257,02 <b>311,00</b>	261,16 <b>316,00</b>	247,93 <b>300,00</b>	261,16 <b>316,00</b>	270,25 <b>327,00</b>	258,68 <b>313,00</b>	274,38 <b>332,00</b>	285,12 <b>345,00</b>	274,38 <b>332,00</b>	295,87 <b>358,00</b>	-
	232,23 <b>281,00</b>	257,02 <b>311,00</b>	261,16 <b>316,00</b>	247,93 <b>300,00</b>	261,16 <b>316,00</b>	270,25 <b>327,00</b>	258,68 <b>313,00</b>	274,38 <b>332,00</b>	285,12 <b>345,00</b>	274,38 <b>332,00</b>	295,87 <b>358,00</b>	-
	369,42 <b>447,00</b>	407,44 <b>493,00</b>	414,05 <b>501,00</b>	-	-	-	-	-	-	-	-	-
	27,27 <b>33,00</b>	28,10 <b>34,00</b>	30,58 <b>37,00</b>	27,27 <b>33,00</b>	28,10 <b>34,00</b>	29,75 <b>36,00</b>	28,93 <b>35,00</b>	29,75 <b>36,00</b>	31,40 <b>38,00</b>	28,93 <b>35,00</b>	30,58 <b>37,00</b>	32,23 <b>39,00</b>
	28,93 <b>35,00</b>	29,75 <b>36,00</b>	32,23 <b>39,00</b>	28,93 <b>35,00</b>	29,75 <b>36,00</b>	30,58 <b>37,00</b>	29,75 <b>36,00</b>	30,58 <b>37,00</b>	32,23 <b>39,00</b>	29,75 <b>36,00</b>	32,23 <b>39,00</b>	33,06 <b>40,00</b>
	-	-	-	-	-	-	-	-	-	-	-	-
	85,95 <b>104,00</b>	88,43 <b>107,00</b>	115,70 <b>140,00</b>	85,95 <b>104,00</b>	87,60 <b>106,00</b>	90,91 <b>110,00</b>	88,43 <b>107,00</b>	90,91 <b>110,00</b>	93,39 <b>113,00</b>	92,56 <b>112,00</b>	94,21 <b>114,00</b>	-
	85,95 <b>104,00</b>	88,43 <b>107,00</b>	115,70 <b>140,00</b>	85,95 <b>104,00</b>	87,60 <b>106,00</b>	90,91 <b>110,00</b>	88,43 <b>107,00</b>	90,91 <b>110,00</b>	93,39 <b>113,00</b>	92,56 <b>112,00</b>	94,21 <b>114,00</b>	-
	25,62 <b>31,00</b>	25,62 <b>31,00</b>	25,62 <b>31,00</b>	25,62 <b>31,00</b>	25,62 <b>31,00</b>	25,62 <b>31,00</b>	25,62 <b>31,00</b>	25,62 <b>31,00</b>	25,62 <b>31,00</b>	25,62 <b>31,00</b>	25,62 <b>31,00</b>	25,62 <b>31,00</b>

Cenas bez PVN, Euro Cenas ar PVN, Euro								
Izmērs (cm)	CK02 55x78	CK04 55x98	CK06 55x118	FK04 66x98	FK06 66x118	FK08 66x140	MK04 78x98	MK06 78x118









## AILES APDARE

Iebūvēšanas  
slīpums

**Gatavs risinājums ailes apdarei. Aile veidota no ūdens izturīgiem materiāliem un ideāli sader ar VELUX jumta logu**

<b>LSB 2000</b>	Ailes apdare jumta biežumam līdz 300 mm, viena loga iebūvēšanai	15-90	223,97 <b>271,00</b>	228,93 <b>277,00</b>	233,88 <b>283,00</b>	233,88 <b>283,00</b>	238,84 <b>289,00</b>	248,76 <b>301,00</b>	238,84 <b>289,00</b>	243,80 <b>295,00</b>
<b>LSB 2021B</b>	Ailes apdare jumta biežumam līdz 300 mm, divu logu kombinētai iebūvēšanai	15-90	448,76 <b>543,00</b>	458,68 <b>555,00</b>	467,77 <b>566,00</b>	467,77 <b>566,00</b>	477,69 <b>578,00</b>	497,52 <b>602,00</b>	477,69 <b>578,00</b>	487,60 <b>590,00</b>
<b>LSB 2021E</b>	Ailes apdare jumta biežumam līdz 300 mm, kombinētai iebūvēšanai	15-90	448,76 <b>543,00</b>	458,68 <b>555,00</b>	467,77 <b>566,00</b>	467,77 <b>566,00</b>	477,69 <b>578,00</b>	497,52 <b>602,00</b>	477,69 <b>578,00</b>	487,60 <b>590,00</b>
<b>LSB 2031B</b>	Ailes apdare jumta biežumam līdz 300 mm, trīs logu kombinētai iebūvēšanai	15-90	672,73 <b>814,00</b>	687,60 <b>832,00</b>	702,48 <b>850,00</b>	702,48 <b>850,00</b>	716,53 <b>867,00</b>	746,28 <b>903,00</b>	716,53 <b>867,00</b>	731,40 <b>885,00</b>
<b>LSB 2031E</b>	Ailes apdare jumta biežumam līdz 300 mm, trīs logu kombinētai iebūvēšanai	15-90	672,73 <b>814,00</b>	687,60 <b>832,00</b>	702,48 <b>850,00</b>	702,48 <b>850,00</b>	716,53 <b>867,00</b>	746,28 <b>903,00</b>	716,53 <b>867,00</b>	731,40 <b>885,00</b>
<b>LSC 2000</b>	Ailes apdare jumta biežumam līdz 400 mm, viena loga iebūvēšanai	15-90	280,17 <b>339,00</b>	286,78 <b>347,00</b>	292,56 <b>354,00</b>	292,56 <b>354,00</b>	298,35 <b>361,00</b>	310,74 <b>376,00</b>	298,35 <b>361,00</b>	304,96 <b>369,00</b>
<b>LSC 2021B</b>	Ailes apdare jumta biežumam līdz 400 mm, divu logu kombinētai iebūvēšanai	15-90	561,16 <b>679,00</b>	572,73 <b>693,00</b>	585,12 <b>708,00</b>	585,12 <b>708,00</b>	597,52 <b>723,00</b>	621,49 <b>752,00</b>	597,52 <b>723,00</b>	609,92 <b>738,00</b>
<b>LSC 2021E</b>	Ailes apdare jumta biežumam līdz 400 mm, kombinētai iebūvēšanai	15-90	561,16 <b>679,00</b>	572,73 <b>693,00</b>	585,12 <b>708,00</b>	585,12 <b>708,00</b>	597,52 <b>723,00</b>	621,49 <b>752,00</b>	597,52 <b>723,00</b>	609,92 <b>738,00</b>
<b>LSC 2031B</b>	Ailes apdare jumta biežumam līdz 400 mm, divu logu kombinētai iebūvēšanai	15-90	841,32 <b>1 018,00</b>	859,50 <b>1 040,00</b>	877,69 <b>1 062,00</b>	877,69 <b>1 062,00</b>	895,87 <b>1 084,00</b>	932,23 <b>1 128,00</b>	895,87 <b>1 084,00</b>	914,05 <b>1 106,00</b>
<b>LSD 2000</b>	Ailes apdare jumta biežumam līdz 500 mm, viena loga iebūvēšanai	15-90	380,99 <b>461,00</b>	389,26 <b>471,00</b>	397,52 <b>481,00</b>	397,52 <b>481,00</b>	405,79 <b>491,00</b>	423,14 <b>512,00</b>	405,79 <b>491,00</b>	414,88 <b>502,00</b>
<b>LSD 2021B</b>	Ailes apdare jumta biežumam līdz 500 mm, kombinētai divu logu iebūvēšanai	15-90	257,85 <b>312,00</b>	263,64 <b>319,00</b>	268,60 <b>325,00</b>	268,60 <b>325,00</b>	274,38 <b>332,00</b>	285,95 <b>346,00</b>	274,38 <b>332,00</b>	280,17 <b>339,00</b>
<b>LSD 2021E</b>	Ailes apdare jumta biežumam līdz 500 mm, kombinētai iebūvēšanai	15-90	257,85 <b>312,00</b>	263,64 <b>319,00</b>	268,60 <b>325,00</b>	268,60 <b>325,00</b>	274,38 <b>332,00</b>	285,95 <b>346,00</b>	274,38 <b>332,00</b>	280,17 <b>339,00</b>











Ailes apdare LSB, LSC, LSD ir saderīga gan ar VELUX jaunākās paaudzes jumta logiem, gan ar iepriekšējās paaudzes jumta logiem.

Cenas bez PVN, Euro Cenas ar PVN, Euro								
Izmērs (cm)	CK02 55x78	CK04 55x98	CK06 55x118	FK04 66x98	FK06 66x118	FK08 66x140	MK04 78x98	MK06 78x118











## ZWC: SĀNU UN APAKŠĒJĀS MALAS UZLIKAS AR PAGARINĀJUMU AUGŠĒJAI MALAI

Iebūvēšanas  
slīpums

<b>ZWC 0000</b>	Uzliku komplekts, kurā ietilpst apakšējais un sānu rāmju pārsegi, ZWC ir nepieciešams, ja vēlaties iebūvēt VELUX jumta logu, neizmantojot VELUX pieslēgumu.	-	21,49 <b>26,00</b>	23,97 <b>29,00</b>	25,62 <b>31,00</b>	25,62 <b>31,00</b>	28,10 <b>34,00</b>	29,75 <b>36,00</b>	27,27 <b>33,00</b>	28,93 <b>35,00</b>
<b>ZWC 0000T</b>	Uzliku komplekts, kurā ietilpst apakšējais un sānu rāmju pārsegi, kā arī pagarinājums augšējām pārsegam, ZWC ir nepieciešams, ja vēlaties iebūvēt VELUX jumta logu, neizmantojot VELUX pieslēgumu.	-	21,49 <b>26,00</b>	23,97 <b>29,00</b>	25,62 <b>31,00</b>	25,62 <b>31,00</b>	28,10 <b>34,00</b>	29,75 <b>36,00</b>	27,27 <b>33,00</b>	28,93 <b>35,00</b>



 MK08 78x140	 MK12 78x180	 PK06 94x118	 PK08 94x140	 PK10 94x160	 SK06 114x118	 SK08 114x140	 SK10 114x160	 UK04 134x98	 UK08 134x140	 UK10 134x160
---	---	---	---	---	--	--	--	---	--	--

253,72 <b>307,00</b>	341,32 <b>413,00</b>	253,72 <b>307,00</b>	258,68 <b>313,00</b>	268,60 <b>325,00</b>	261,16 <b>316,00</b>	268,60 <b>325,00</b>	275,21 <b>333,00</b>	272,73 <b>330,00</b>	277,69 <b>336,00</b>	285,12 <b>345,00</b>
507,44 <b>614,00</b>	682,64 <b>826,00</b>	507,44 <b>614,00</b>	516,53 <b>625,00</b>	536,36 <b>649,00</b>	521,49 <b>631,00</b>	536,36 <b>649,00</b>	551,24 <b>667,00</b>	546,28 <b>661,00</b>	556,20 <b>673,00</b>	570,25 <b>690,00</b>
507,44 <b>614,00</b>	682,64 <b>826,00</b>	507,44 <b>614,00</b>	516,53 <b>625,00</b>	536,36 <b>649,00</b>	521,49 <b>631,00</b>	536,36 <b>649,00</b>	551,24 <b>667,00</b>	546,28 <b>661,00</b>	556,20 <b>673,00</b>	570,25 <b>690,00</b>
760,33 <b>920,00</b>	1 023,97 <b>1 239,00</b>	-	-	-	-	-	-	-	-	-
760,33 <b>920,00</b>	1 023,97 <b>1 239,00</b>	-	-	-	-	-	-	-	-	-
317,36 <b>384,00</b>	426,45 <b>516,00</b>	317,36 <b>384,00</b>	323,14 <b>391,00</b>	335,54 <b>406,00</b>	326,45 <b>395,00</b>	335,54 <b>406,00</b>	344,63 <b>417,00</b>	341,32 <b>413,00</b>	347,11 <b>420,00</b>	356,20 <b>431,00</b>
633,88 <b>767,00</b>	853,72 <b>1 033,00</b>	633,88 <b>767,00</b>	646,28 <b>782,00</b>	670,25 <b>811,00</b>	652,07 <b>789,00</b>	670,25 <b>811,00</b>	688,43 <b>833,00</b>	682,64 <b>826,00</b>	695,04 <b>841,00</b>	713,22 <b>863,00</b>
633,88 <b>767,00</b>	853,72 <b>1 033,00</b>	633,88 <b>767,00</b>	646,28 <b>782,00</b>	670,25 <b>811,00</b>	652,07 <b>789,00</b>	670,25 <b>811,00</b>	688,43 <b>833,00</b>	682,64 <b>826,00</b>	695,04 <b>841,00</b>	713,22 <b>863,00</b>
951,24 <b>1 151,00</b>	1 280,17 <b>1 549,00</b>	-	-	-	-	-	-	-	-	-
431,40 <b>522,00</b>	580,17 <b>702,00</b>	431,40 <b>522,00</b>	439,67 <b>532,00</b>	456,20 <b>552,00</b>	443,80 <b>537,00</b>	456,20 <b>552,00</b>	468,60 <b>567,00</b>	464,46 <b>562,00</b>	472,73 <b>572,00</b>	485,12 <b>587,00</b>
291,74 <b>353,00</b>	392,56 <b>475,00</b>	-	-	-	-	-	-	-	-	-
291,74 <b>353,00</b>	392,56 <b>475,00</b>	-	-	-	-	-	-	-	-	-

 MK08 78x140	 MK10 78x160	 MK12 78x180	 PK06 94x118	 PK08 94x140	 PK10 94x160	 SK06 114x118	 SK08 114x140	 SK10 114x160	 UK04 134x98	 UK08 134x140	 UK10 134x160
---	---	---	---	---	---	--	--	--	---	--	--

30,58 <b>37,00</b>	36,36 <b>44,00</b>	41,32 <b>50,00</b>	33,88 <b>41,00</b>	36,36 <b>44,00</b>	39,67 <b>48,00</b>	36,36 <b>44,00</b>	40,50 <b>49,00</b>	44,63 <b>54,00</b>	37,19 <b>45,00</b>	44,63 <b>54,00</b>	50,41 <b>61,00</b>
30,58 <b>37,00</b>	36,36 <b>44,00</b>	41,32 <b>50,00</b>	33,88 <b>41,00</b>	36,36 <b>44,00</b>	39,67 <b>48,00</b>	36,36 <b>44,00</b>	40,50 <b>49,00</b>	44,63 <b>54,00</b>	37,19 <b>45,00</b>	44,63 <b>54,00</b>	50,41 <b>61,00</b>

# ŽALŪZIJAS UN SLĒĢI

Jumta logiem, kuri ražoti no 2014. gada										
Loga kods	CK02	CK04	CK06	FK04	FK06	FK08	MK04	MK06		
Slēgi	CK02	CK04	CK06	FK04	FK06	FK08	MK04	MK06		
Žalūzijas/saulessargs ar slīdēm	CK02	CK04	CK06	FK04	FK06	FK08	MK04	MK06		
Žalūzijas/saulessargs ar āķiem	CK00	CK00	CK00	FK00	FK00	FK00	MK00	MK00		
Jumta logiem, kuri ražoti no 2003. līdz 2014. gadam										
Loga kods	C02	C04	C06	F04	F06	F08	M04	M06		
Slēgi	CK02	CK04	CK06	FK04	FK06	FK08	MK04	MK06		
Žalūzijas/saulessargs ar slīdēm	C02	C04	C06	F04	F06	F08	M04	M06		
Žalūzijas/saulessargs ar āķiem	CK00	CK00	CK00	FK00	FK00	FK00	MK00	MK00		
Jumta logiem, kuri ražoti no 1992. līdz 2003. gadam										
Loga kods	102	104	-	204	206	-	304	306		
Slēgi	CK02	CK04	-	FK04	FK06	-	MK04	MK06		
Žalūzijas/saulessargs ar slīdēm	102	104	-	204	206	-	M04	M06		
Žalūzijas/saulessargs ar āķiem	100	100	-	200	200	-	MK00	MK00		
Kods	Darbība	Krāsa	Loga rāmja izmērs (cm)							
			55x78	55x98	55x118	66x98	66x118	66x140	78x98	78x118
Cenas bez PVN, Euro										
Cenas ar PVN, Euro			CK02	CK04	CK06	FK04	FK06	FK08	MK04	MK06

## GAISMAS KONTROLE

Ruļļveida žalūzijas ar āķiem

RHL	Manuāla	standarta		36,36 44,00			42,15 51,00		45,45 55,00	
-----	---------	-----------	--	----------------	--	--	----------------	--	----------------	--

Ruļļveida žalūzijas

RFY	Manuāla	Dabas kolekcija	82,64 100,00	87,60 106,00	95,04 115,00	94,21 114,00	100,83 122,00	104,13 126,00	97,52 118,00	104,13 126,00
RFL	Manuāla	standarta	61,98 75,00	66,12 80,00	72,73 88,00	71,90 87,00	77,69 94,00	80,99 98,00	75,21 91,00	80,99 98,00
	Manuāla	dizaina, Colour by You	76,03 92,00	80,17 97,00	86,78 105,00	85,95 104,00	91,74 111,00	95,04 115,00	89,26 108,00	95,04 115,00
RML	Elektriska	standarta	152,07 184,00	156,20 189,00	162,81 197,00	161,98 196,00	167,77 203,00	171,07 207,00	165,29 200,00	171,07 207,00
	Elektriska	dizaina, Colour by You	166,12 201,00	170,25 206,00	176,86 214,00	176,03 213,00	181,82 220,00	185,12 224,00	179,34 217,00	185,12 224,00
RSL	Solāra	standarta	152,07 184,00	156,20 189,00	162,81 197,00	161,98 196,00	167,77 203,00	171,07 207,00	165,29 200,00	171,07 207,00
	Solāra	dizaina, Colour by You	166,12 201,00	170,25 206,00	176,86 214,00	176,03 213,00	181,82 220,00	185,12 224,00	179,34 217,00	185,12 224,00

Gaismu necaurīdīgās žalūzijas

DKY	Manuāla	Dabas kolekcija	82,64 100,00	87,60 106,00	95,04 115,00	94,21 114,00	100,83 122,00	104,13 126,00	97,52 118,00	104,13 126,00
DKL	Manuāla	standarta	68,60 83,00	73,55 89,00	80,99 98,00	80,17 97,00	86,78 105,00	90,08 109,00	83,47 101,00	90,08 109,00
	Manuāla	dizaina, Colour by You, Kolekcija bērniem	82,64 100,00	87,60 106,00	95,04 115,00	94,21 114,00	100,83 122,00	104,13 126,00	97,52 118,00	104,13 126,00
DML	Elektriska	standarta	158,68 192,00	163,64 198,00	171,07 207,00	170,25 206,00	176,86 214,00	180,17 218,00	173,55 210,00	180,17 218,00
	Elektriska	dizaina, Colour by You	172,73 209,00	177,69 215,00	185,12 224,00	184,30 223,00	190,91 231,00	194,21 235,00	187,60 227,00	194,21 235,00
DSL	Solāra	standarta	158,68 192,00	163,64 198,00	171,07 207,00	170,25 206,00	176,86 214,00	180,17 218,00	173,55 210,00	180,17 218,00
	Solāra	dizaina, Colour by You	172,73 209,00	177,69 215,00	185,12 224,00	184,30 223,00	190,91 231,00	194,21 235,00	187,60 227,00	194,21 235,00

DUO gaismu necaurīdīgās žalūzijas

DFD	Manuāla	standarta	89,26 108,00	95,87 116,00	105,79 128,00	104,13 126,00	112,40 136,00	117,36 142,00	109,09 132,00	117,36 142,00
	Manuāla	dizaina, Colour by You, Kolekcija bērniem	103,31 125,00	109,92 133,00	119,83 145,00	118,18 143,00	126,45 153,00	131,40 159,00	123,14 149,00	131,40 159,00

	MK08	MK10	MK12	PK06	PK08	PK10	SK06	SK08	SK10	UK04	UK08	UK10
	MK08	MK10	MK12	PK06	PK08	PK10	SK06	SK08	SK10	UK04	UK08	UK10
	MK08	MK10	MK12	PK06	PK08	PK10	SK06	SK08	SK10	UK04	UK08	UK10
	MK00	MK00	MK12	PK00	PK00	PK00	SK00	SK00	SK00	UK00	UK00	UK00

	M08	M10	M12	P06	P08	P10	S06	S08	S10	U04	U08	U10
	MK08	MK10	MK12	PK06	PK08	PK10	SK06	SK08	SK10	UK04	UK08	UK10
	M08	M10	M12	P06	P08	P10	S06	S08	S10	U04	U08	U10
	MK00	MK00	MK12	PK00	PK00	PK00	SK00	SK00	SK10	UK00	UK00	UK00

	308	310	-	406	408	410	606	608	610	804	808	810
	MK08	MK10	-	PK06	PK08	PK10	SK06	SK08	SK10	UK04	UK08	UK10
	M08	M10	-	P06	P08	P10	S06	S08	S10	U04	U08	U10
	MK00	MK00	-	PK00	PK00	PK00	SK00	SK00	SK00	UK00	UK00	UK00



	78x140	78x160	78x180	94x118	94x140	94x160	114x118	114x140	114x160	134x98	134x140	134x160
	MK08	MK10	MK12	PK06	PK08	PK10	SK06	SK08	SK10	UK04	UK08	UK10

	45,45 55,00	-	52,07 63,00	57,85 70,00	62,81 76,00
--	----------------	---	----------------	----------------	----------------

	110,74 134,00	122,31 148,00	131,40 159,00	113,22 137,00	122,31 148,00	128,10 155,00	126,45 153,00	131,40 159,00	144,63 175,00	129,75 157,00	146,28 177,00	152,89 185,00
	86,78 105,00	97,52 118,00	105,79 128,00	89,26 108,00	97,52 118,00	103,31 125,00	101,65 123,00	105,79 128,00	117,36 142,00	104,13 126,00	119,01 144,00	124,79 151,00
	100,83 122,00	111,57 135,00	119,83 145,00	103,31 125,00	111,57 135,00	117,36 142,00	115,70 140,00	119,83 145,00	131,40 159,00	118,18 143,00	133,06 161,00	138,84 168,00
	176,86 214,00	187,60 227,00	195,87 237,00	179,34 217,00	187,60 227,00	193,39 234,00	191,74 232,00	195,87 237,00	207,44 251,00	194,21 235,00	209,09 253,00	214,88 260,00
	190,91 231,00	201,65 244,00	209,92 254,00	193,39 234,00	201,65 244,00	207,44 251,00	205,79 249,00	209,92 254,00	221,49 268,00	208,26 252,00	223,14 270,00	228,93 277,00
	176,86 214,00	187,60 227,00	195,87 237,00	179,34 217,00	187,60 227,00	193,39 234,00	191,74 232,00	195,87 237,00	207,44 251,00	194,21 235,00	209,09 253,00	214,88 260,00
	190,91 231,00	201,65 244,00	209,92 254,00	193,39 234,00	201,65 244,00	207,44 251,00	205,79 249,00	209,92 254,00	221,49 268,00	208,26 252,00	223,14 270,00	228,93 277,00

	110,74 134,00	122,31 148,00	131,40 159,00	113,22 137,00	122,31 148,00	128,10 155,00	126,45 153,00	131,40 159,00	144,63 175,00	129,75 157,00	146,28 177,00	152,89 185,00
	96,69 117,00	108,26 131,00	117,36 142,00	99,17 120,00	108,26 131,00	114,05 138,00	112,40 136,00	117,36 142,00	130,58 158,00	115,70 140,00	132,23 160,00	138,84 168,00
	110,74 134,00	122,31 148,00	131,40 159,00	113,22 137,00	122,31 148,00	128,10 155,00	126,45 153,00	131,40 159,00	144,63 175,00	129,75 157,00	146,28 177,00	152,89 185,00
	186,78 226,00	198,35 240,00	207,44 251,00	189,26 229,00	198,35 240,00	204,13 247,00	202,48 245,00	207,44 251,00	220,66 267,00	205,79 249,00	222,31 269,00	228,93 277,00
	200,83 243,00	212,40 257,00	221,49 268,00	203,31 246,00	212,40 257,00	218,18 264,00	216,53 262,00	221,49 268,00	234,71 284,00	219,83 266,00	236,36 286,00	242,98 294,00
	186,78 226,00	198,35 240,00	207,44 251,00	189,26 229,00	198,35 240,00	204,13 247,00	202,48 245,00	207,44 251,00	220,66 267,00	205,79 249,00	222,31 269,00	228,93 277,00
	200,83 243,00	212,40 257,00	221,49 268,00	203,31 246,00	212,40 257,00	218,18 264,00	216,53 262,00	221,49 268,00	234,71 284,00	219,83 266,00	236,36 286,00	242,98 294,00

	125,62 152,00	140,50 170,00	-	128,93 156,00	140,50 170,00	148,76 180,00	146,28 177,00	152,07 184,00	169,42 205,00	149,59 181,00	171,90 208,00	180,17 218,00
	139,67 169,00	154,55 187,00	-	142,98 173,00	154,55 187,00	162,81 197,00	160,33 194,00	166,12 201,00	183,47 222,00	163,64 198,00	185,95 225,00	194,21 235,00

<b>Jumta logiem, kuri ražoti no 2014. gada</b>										
Loga kods	CK02	CK04	CK06	FK04	FK06	FK08	MK04	MK06		
Slēgi	CK02	CK04	CK06	FK04	FK06	FK08	MK04	MK06		
Žalūzijas/saulessargs ar sliedēm	CK02	CK04	CK06	FK04	FK06	FK08	MK04	MK06		
Žalūzijas/saulessargs ar āķiem	CK00	CK00	CK00	FK00	FK00	FK00	MK00	MK00		
<b>Jumta logiem, kuri ražoti no 2003. līdz 2014. gadam</b>										
Loga kods	C02	C04	C06	F04	F06	F08	M04	M06		
Slēgi	CK02	CK04	CK06	FK04	FK06	FK08	MK04	MK06		
Žalūzijas/saulessargs ar sliedēm	C02	C04	C06	F04	F06	F08	M04	M06		
Žalūzijas/saulessargs ar āķiem	CK00	CK00	CK00	FK00	FK00	FK00	MK00	MK00		
<b>Jumta logiem, kuri ražoti no 1992. līdz 2003. gadam</b>										
Loga kods	102	104	-	204	206	-	304	306		
Slēgi	CK02	CK04	-	FK04	FK06	-	MK04	MK06		
Žalūzijas/saulessargs ar sliedēm	102	104	-	204	206	-	M04	M06		
Žalūzijas/saulessargs ar āķiem	100	100	-	200	200	-	MK00	MK00		
Kods	Darbība	Krāsa	Loga rāmja izmērs (cm)							
			55x78	55x98	55x118	66x98	66x118	66x140	78x98	78x118
Cenas bez PVN, Euro			CK02	CK04	CK06	FK04	FK06	FK08	MK04	MK06
Cenas ar PVN, Euro										
Plisētās žalūzijas										
FHL	Manuāla	standarta	89,26 <b>108,00</b>	95,87 <b>116,00</b>	105,79 <b>128,00</b>	104,13 <b>126,00</b>	112,40 <b>136,00</b>	117,36 <b>142,00</b>	109,09 <b>132,00</b>	117,36 <b>142,00</b>
	Manuāla	dizaina	103,31 <b>125,00</b>	109,92 <b>133,00</b>	119,83 <b>145,00</b>	118,18 <b>143,00</b>	126,45 <b>153,00</b>	131,40 <b>159,00</b>	123,14 <b>149,00</b>	131,40 <b>159,00</b>
FML	Elektriska	standarta	179,34 <b>217,00</b>	185,95 <b>225,00</b>	195,87 <b>237,00</b>	194,21 <b>235,00</b>	202,48 <b>245,00</b>	207,44 <b>251,00</b>	199,17 <b>241,00</b>	207,44 <b>251,00</b>
	Elektriska	dizaina	193,39 <b>234,00</b>	200,00 <b>242,00</b>	209,92 <b>254,00</b>	208,26 <b>252,00</b>	216,53 <b>262,00</b>	221,49 <b>268,00</b>	213,22 <b>258,00</b>	221,49 <b>268,00</b>
FSL	Solāra	standarta	179,34 <b>217,00</b>	185,95 <b>225,00</b>	195,87 <b>237,00</b>	194,21 <b>235,00</b>	202,48 <b>245,00</b>	207,44 <b>251,00</b>	199,17 <b>241,00</b>	207,44 <b>251,00</b>
	Solāra	dizaina	193,39 <b>234,00</b>	200,00 <b>242,00</b>	209,92 <b>254,00</b>	208,26 <b>252,00</b>	216,53 <b>262,00</b>	221,49 <b>268,00</b>	213,22 <b>258,00</b>	221,49 <b>268,00</b>
Energoefektīvās gaismu necaurlaidīgās žalūzijas										
FHC	Manuāla	standarta	89,26 <b>108,00</b>	95,87 <b>116,00</b>	105,79 <b>128,00</b>	104,13 <b>126,00</b>	112,40 <b>136,00</b>	117,36 <b>142,00</b>	109,09 <b>132,00</b>	117,36 <b>142,00</b>
	Manuāla	dizaina	103,31 <b>125,00</b>	109,92 <b>133,00</b>	119,83 <b>145,00</b>	118,18 <b>143,00</b>	126,45 <b>153,00</b>	131,40 <b>159,00</b>	123,14 <b>149,00</b>	131,40 <b>159,00</b>
FMC	Elektriska	standarta	179,34 <b>217,00</b>	185,95 <b>225,00</b>	195,87 <b>237,00</b>	194,21 <b>235,00</b>	202,48 <b>245,00</b>	207,44 <b>251,00</b>	199,17 <b>241,00</b>	207,44 <b>251,00</b>
	Elektriska	dizaina	193,39 <b>234,00</b>	200,00 <b>242,00</b>	209,92 <b>254,00</b>	208,26 <b>252,00</b>	216,53 <b>262,00</b>	221,49 <b>268,00</b>	213,22 <b>258,00</b>	221,49 <b>268,00</b>
FSC	Solāra	standarta	179,34 <b>217,00</b>	185,95 <b>225,00</b>	195,87 <b>237,00</b>	194,21 <b>235,00</b>	202,48 <b>245,00</b>	207,44 <b>251,00</b>	199,17 <b>241,00</b>	207,44 <b>251,00</b>
	Solāra	dizaina	193,39 <b>234,00</b>	200,00 <b>242,00</b>	209,92 <b>254,00</b>	208,26 <b>252,00</b>	216,53 <b>262,00</b>	221,49 <b>268,00</b>	213,22 <b>258,00</b>	221,49 <b>268,00</b>
Horizontālās žalūzijas										
PAL	Manuāla	standarta	89,26 <b>108,00</b>	95,87 <b>116,00</b>	105,79 <b>128,00</b>	104,13 <b>126,00</b>	112,40 <b>136,00</b>	117,36 <b>142,00</b>	109,09 <b>132,00</b>	117,36 <b>142,00</b>
Klasiskās, aptumšojošās ruļļveida žalūzijas logiem, kas ražoti no 2000. līdz 2012. gadam										
DBL	Manuāla	standarta	47,93 <b>58,00</b>	52,07 <b>63,00</b>	-	56,20 <b>68,00</b>	60,33 <b>73,00</b>	-	58,68 <b>71,00</b>	62,81 <b>76,00</b>

Ruļļveida žalūzijas var pasūtīt ar alumīnija vai baltām sānu sliedēm. Pasūtot vienmēr jānorāda nepieciešamais sānu sliežu veids, izņemot RHZ un RHL.

Piemērs: DKL MK06 1025S – alumīnija sliedes

DKL MK06 1025SWL – baltas sliedes

Piederumi jāpasūta atbilstoši jumta loga kodam. Šī brīža jumta loga paaudzes kods ietver burtu K, piemēram, MK06, tāda paša izmēra iepriekšējās paaudzes izmēra kods ir bez burta K, piemēram, M06.

Lai pasūtītu slēgus un žalūzijas jumta logiem, kas iegādāti pirms 2002. gada, lūdzam sazināties ar klientu servisu.

Elektriski vadāmi piederumi ir paredzēti savienošanai ar GGL/GGU elektriskajiem jumta logiem vai KUX 110 vadības bloku. Uzstādot tālvadības produktus uz manuāli vadāmiem logiem vai logiem ar KMG motora bloku, nepieciešams pasūtīt ZOZ 241/243 adapteri.

	MK08	MK10	MK12	PK06	PK08	PK10	SK06	SK08	SK10	UK04	UK08	UK10
	MK08	MK10	MK12	PK06	PK08	PK10	SK06	SK08	SK10	UK04	UK08	UK10
	MK08	MK10	MK12	PK06	PK08	PK10	SK06	SK08	SK10	UK04	UK08	UK10
	MK00	MK00	MK12	PK00	PK00	PK00	SK00	SK00	SK00	UK00	UK00	UK00

	M08	M10	M12	P06	P08	P10	S06	S08	S10	U04	U08	U10
	MK08	MK10	MK12	PK06	PK08	PK10	SK06	SK08	SK10	UK04	UK08	UK10
	M08	M10	M12	P06	P08	P10	S06	S08	S10	U04	U08	U10
	MK00	MK00	MK12	PK00	PK00	PK00	SK00	SK00	SK10	UK00	UK00	UK00

	308	310	-	406	408	410	606	608	610	804	808	810
	MK08	MK10	-	PK06	PK08	PK10	SK06	SK08	SK10	UK04	UK08	UK10
	M08	M10	-	P06	P08	P10	S06	S08	S10	U04	U08	U10
	MK00	MK00	-	PK00	PK00	PK00	SK00	SK00	SK00	UK00	UK00	UK00

	78x140	78x160	78x180	94x118	94x140	94x160	114x118	114x140	114x160	134x98	134x140	134x160
	MK08	MK10	MK12	PK06	PK08	PK10	SK06	SK08	SK10	UK04	UK08	UK10

	125,62 <b>152,00</b>	140,50 <b>170,00</b>	152,07 <b>184,00</b>	128,93 <b>156,00</b>	140,50 <b>170,00</b>	148,76 <b>180,00</b>	146,28 <b>177,00</b>	152,07 <b>184,00</b>	169,42 <b>205,00</b>	149,59 <b>181,00</b>	171,90 <b>208,00</b>	180,17 <b>218,00</b>
--	-------------------------	-------------------------	-------------------------	-------------------------	-------------------------	-------------------------	-------------------------	-------------------------	-------------------------	-------------------------	-------------------------	-------------------------

	139,67 <b>169,00</b>	154,55 <b>187,00</b>	166,12 <b>201,00</b>	142,98 <b>173,00</b>	154,55 <b>187,00</b>	162,81 <b>197,00</b>	160,33 <b>194,00</b>	166,12 <b>201,00</b>	183,47 <b>222,00</b>	163,64 <b>198,00</b>	185,95 <b>225,00</b>	194,21 <b>235,00</b>
--	-------------------------	-------------------------	-------------------------	-------------------------	-------------------------	-------------------------	-------------------------	-------------------------	-------------------------	-------------------------	-------------------------	-------------------------

	215,70 <b>261,00</b>	230,58 <b>279,00</b>	242,15 <b>293,00</b>	219,01 <b>265,00</b>	230,58 <b>279,00</b>	238,84 <b>289,00</b>	236,36 <b>286,00</b>	242,15 <b>293,00</b>	259,50 <b>314,00</b>	239,67 <b>290,00</b>	261,98 <b>317,00</b>	270,25 <b>327,00</b>
--	-------------------------	-------------------------	-------------------------	-------------------------	-------------------------	-------------------------	-------------------------	-------------------------	-------------------------	-------------------------	-------------------------	-------------------------

	229,75 <b>278,00</b>	244,63 <b>296,00</b>	256,20 <b>310,00</b>	233,06 <b>282,00</b>	244,63 <b>296,00</b>	252,89 <b>306,00</b>	250,41 <b>303,00</b>	256,20 <b>310,00</b>	273,55 <b>331,00</b>	253,72 <b>307,00</b>	276,03 <b>334,00</b>	284,30 <b>344,00</b>
--	-------------------------	-------------------------	-------------------------	-------------------------	-------------------------	-------------------------	-------------------------	-------------------------	-------------------------	-------------------------	-------------------------	-------------------------

	215,70 <b>261,00</b>	230,58 <b>279,00</b>	242,15 <b>293,00</b>	219,01 <b>265,00</b>	230,58 <b>279,00</b>	238,84 <b>289,00</b>	236,36 <b>286,00</b>	242,15 <b>293,00</b>	259,50 <b>314,00</b>	239,67 <b>290,00</b>	261,98 <b>317,00</b>	270,25 <b>327,00</b>
--	-------------------------	-------------------------	-------------------------	-------------------------	-------------------------	-------------------------	-------------------------	-------------------------	-------------------------	-------------------------	-------------------------	-------------------------

	229,75 <b>278,00</b>	244,63 <b>296,00</b>	256,20 <b>310,00</b>	233,06 <b>282,00</b>	244,63 <b>296,00</b>	252,89 <b>306,00</b>	250,41 <b>303,00</b>	256,20 <b>310,00</b>	273,55 <b>331,00</b>	253,72 <b>307,00</b>	276,03 <b>334,00</b>	284,30 <b>344,00</b>
--	-------------------------	-------------------------	-------------------------	-------------------------	-------------------------	-------------------------	-------------------------	-------------------------	-------------------------	-------------------------	-------------------------	-------------------------

	125,62 <b>152,00</b>	140,50 <b>170,00</b>	152,07 <b>184,00</b>	128,93 <b>156,00</b>	140,50 <b>170,00</b>	148,76 <b>180,00</b>	146,28 <b>177,00</b>	152,07 <b>184,00</b>	169,42 <b>205,00</b>	149,59 <b>181,00</b>	171,90 <b>208,00</b>	180,17 <b>218,00</b>
--	-------------------------	-------------------------	-------------------------	-------------------------	-------------------------	-------------------------	-------------------------	-------------------------	-------------------------	-------------------------	-------------------------	-------------------------

	139,67 <b>169,00</b>	154,55 <b>187,00</b>	166,12 <b>201,00</b>	142,98 <b>173,00</b>	154,55 <b>187,00</b>	162,81 <b>197,00</b>	160,33 <b>194,00</b>	166,12 <b>201,00</b>	183,47 <b>222,00</b>	163,64 <b>198,00</b>	185,95 <b>225,00</b>	194,21 <b>235,00</b>
--	-------------------------	-------------------------	-------------------------	-------------------------	-------------------------	-------------------------	-------------------------	-------------------------	-------------------------	-------------------------	-------------------------	-------------------------

	215,70 <b>261,00</b>	230,58 <b>279,00</b>	242,15 <b>293,00</b>	219,01 <b>265,00</b>	230,58 <b>279,00</b>	238,84 <b>289,00</b>	236,36 <b>286,00</b>	242,15 <b>293,00</b>	259,50 <b>314,00</b>	239,67 <b>290,00</b>	261,98 <b>317,00</b>	270,25 <b>327,00</b>
--	-------------------------	-------------------------	-------------------------	-------------------------	-------------------------	-------------------------	-------------------------	-------------------------	-------------------------	-------------------------	-------------------------	-------------------------

	229,75 <b>278,00</b>	244,63 <b>296,00</b>	256,20 <b>310,00</b>	233,06 <b>282,00</b>	244,63 <b>296,00</b>	252,89 <b>306,00</b>	250,41 <b>303,00</b>	256,20 <b>310,00</b>	273,55 <b>331,00</b>	253,72 <b>307,00</b>	276,03 <b>334,00</b>	284,30 <b>344,00</b>
--	-------------------------	-------------------------	-------------------------	-------------------------	-------------------------	-------------------------	-------------------------	-------------------------	-------------------------	-------------------------	-------------------------	-------------------------

	215,70 <b>261,00</b>	230,58 <b>279,00</b>	242,15 <b>293,00</b>	219,01 <b>265,00</b>	230,58 <b>279,00</b>	238,84 <b>289,00</b>	236,36 <b>286,00</b>	242,15 <b>293,00</b>	259,50 <b>314,00</b>	239,67 <b>290,00</b>	261,98 <b>317,00</b>	270,25 <b>327,00</b>
--	-------------------------	-------------------------	-------------------------	-------------------------	-------------------------	-------------------------	-------------------------	-------------------------	-------------------------	-------------------------	-------------------------	-------------------------

	229,75 <b>278,00</b>	244,63 <b>296,00</b>	256,20 <b>310,00</b>	233,06 <b>282,00</b>	244,63 <b>296,00</b>	252,89 <b>306,00</b>	250,41 <b>303,00</b>	256,20 <b>310,00</b>	273,55 <b>331,00</b>	253,72 <b>307,00</b>	276,03 <b>334,00</b>	284,30 <b>344,00</b>
--	-------------------------	-------------------------	-------------------------	-------------------------	-------------------------	-------------------------	-------------------------	-------------------------	-------------------------	-------------------------	-------------------------	-------------------------

	125,62 <b>152,00</b>	140,50 <b>170,00</b>	152,07 <b>184,00</b>	128,93 <b>156,00</b>	140,50 <b>170,00</b>	148,76 <b>180,00</b>	146,28 <b>177,00</b>	152,07 <b>184,00</b>	169,42 <b>205,00</b>	149,59 <b>181,00</b>	171,90 <b>208,00</b>	180,17 <b>218,00</b>
--	-------------------------	-------------------------	-------------------------	-------------------------	-------------------------	-------------------------	-------------------------	-------------------------	-------------------------	-------------------------	-------------------------	-------------------------

	67,77 <b>82,00</b>	76,03 <b>92,00</b>	-	69,42 <b>84,00</b>	76,03 <b>92,00</b>	-	78,51 <b>95,00</b>	81,82 <b>99,00</b>	-	80,99 <b>98,00</b>	92,56 <b>112,00</b>	-
--	-----------------------	-----------------------	---	-----------------------	-----------------------	---	-----------------------	-----------------------	---	-----------------------	------------------------	---

Izmēru kods  
Rāmja izmērs, cm

CK02  
55x78

CK04  
55x98

CK06  
55x118

FK04  
66x98

FK06  
66x118

FK08  
66x140

MK04  
78x98

MK06  
78x118

## GAISMAS UN TEMPERATŪRAS KONTROLES KOMPLEKTI

### RUĻĻVEIDA ŽALŪZIJAS + SAULESSARGS

ROP (RHL + MHL)	Standarta krāsas	76,61 92,70				88,52 107,10			95,20 115,19
-----------------	------------------	----------------	--	--	--	-----------------	--	--	-----------------

### RUĻĻVEIDA ŽALŪZIJAS + SAULESSARGS

ROF (RFL + MHL)	Standarta krāsas	99,67 120,60	103,39 125,10	109,34 132,30	115,29 139,50	120,50 145,81	123,47 149,40	121,99 147,60	127,19 153,90
-----------------	------------------	-----------------	------------------	------------------	------------------	------------------	------------------	------------------	------------------

### GAISMŪ NECAURLAIDĪGĀS ŽALŪZIJAS + SAULESSARGS

DOP (DKL + MHL)	Standarta krāsas	105,62 127,81	110,08 133,20	116,78 141,30	122,73 148,51	128,68 155,71	131,65 159,30	129,42 156,60	135,37 163,80
-----------------	------------------	------------------	------------------	------------------	------------------	------------------	------------------	------------------	------------------

### ENERGOEFEKTĪVĀS GAISMŪ NECAURLAIDĪGĀS ŽALŪZIJAS + SAULESSARGS

FOP (FHC + MHL)	Standarta krāsas	124,22 150,30	130,17 157,50	139,10 168,30	144,30 174,60	151,74 183,61	156,20 189,01	152,48 184,50	159,92 193,50
-----------------	------------------	------------------	------------------	------------------	------------------	------------------	------------------	------------------	------------------

DOP/FOP komplektu var pasūtīt ar alumīnija vai baltām sānu sliedēm. Pasūtot vienmēr ir jānorāda nepieciešamais sānu sliežu veids. Žalūzijām FHC ar baltām sānu sliedēm nav iekļauts montāžas kronšteinu komplekts uzstādīšanai uz iepriekšējās paaudzes jumta logiem. Bojātu vai iztrūkstošu jumta loga montāžas kronšteinu gadījumā nepieciešams iegādāties ZOZ 230 montāžas komplektu.

#### RFL/RML/RSL/RHL\*

Standarta krāsas

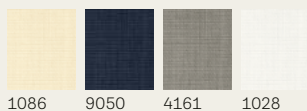

1086 9050 4161 1028

Dizaina krāsas



4163 4162 4069 4164  
4165 4166 4168 4167  
4171 4169 4170 4155

#### DKL/DML/DSL/DFD

Standarta krāsas

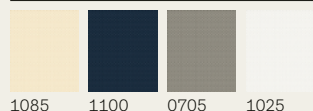

1085 1100 0705 1025

Dizaina krāsas

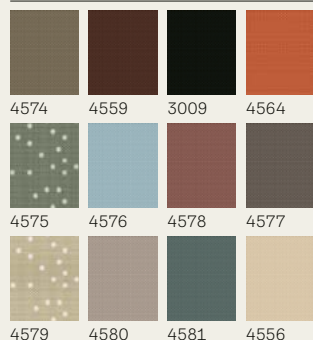

4574 4559 3009 4564  
4575 4576 4578 4577  
4579 4580 4581 4556

#### DKL/DFD

Bērnu kolekcija

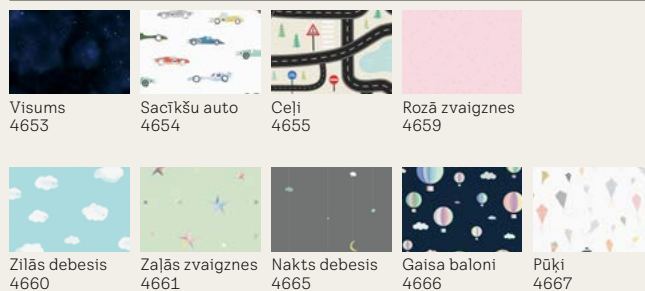

Visums 4653 Sacīkšu auto 4654 Ceļi 4655 Rozā zvaigznes 4659

Zilās debesis 4660 Zaļās zvaigznes 4661 Nakts debesis 4665 Gaisa baloni 4666 Pūķi 4667

\* Žalūzijas RHL pieejamas tikai standarta krāsās.

#### RFY

Dabas kolekcija

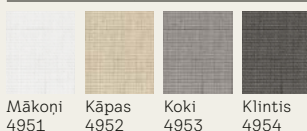

Mākoņi 4951 Kāpas 4952 Koki 4953 Klintis 4954

#### DKY

Dabas kolekcija

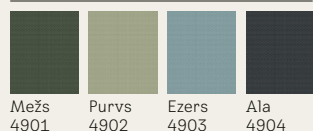







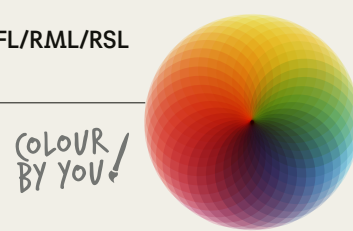

Mežs 4901 Purvs 4902 Ezers 4903 Ala 4904

#### DKL/DML/DSL/RFL/RML/RSL

Colour by You kolekcija





 MK08 78x140	 MK10 78x160	 PK06 94x118	 PK08 94x140	 PK10 94x160	 SK06 114x118	 SK08 114x140	 UK08 134x140
---	---	---	---	---	--	--	--



**IZDEVĪGĀKA CENA, IEGĀDĀJOTIES KOMPLEKTU**

95,20 <b>115,19</b>	110,09 <b>133,21</b>	121,99 <b>147,60</b>	132,40 <b>160,20</b>
------------------------	-------------------------	-------------------------	-------------------------

**IZDEVĪGĀKA CENA, IEGĀDĀJOTIES KOMPLEKTU**

132,40 <b>160,20</b>	142,07 <b>171,90</b>	143,56 <b>173,71</b>	150,99 <b>182,70</b>	156,20 <b>189,01</b>	161,41 <b>195,30</b>	165,13 <b>199,81</b>	182,98 <b>221,40</b>
-------------------------	-------------------------	-------------------------	-------------------------	-------------------------	-------------------------	-------------------------	-------------------------

**IZDEVĪGĀKA CENA, IEGĀDĀJOTIES KOMPLEKTU**

141,32 <b>170,99</b>	151,73 <b>183,59</b>	152,48 <b>184,50</b>	160,66 <b>194,40</b>	165,87 <b>200,70</b>	171,08 <b>207,01</b>	175,55 <b>212,41</b>	194,88 <b>235,80</b>
-------------------------	-------------------------	-------------------------	-------------------------	-------------------------	-------------------------	-------------------------	-------------------------

**IZDEVĪGĀKA CENA, IEGĀDĀJOTIES KOMPLEKTU**

167,36 <b>202,50</b>	180,75 <b>218,70</b>	179,26 <b>216,91</b>	189,68 <b>229,51</b>	197,11 <b>238,50</b>	201,57 <b>243,90</b>	206,78 <b>250,21</b>	230,58 <b>279,00</b>
-------------------------	-------------------------	-------------------------	-------------------------	-------------------------	-------------------------	-------------------------	-------------------------

 FHC/FMC/FSC

Standarta krāsas





			
1045	1047	1163	1156

Dizaina krāsas

			
1164	1165	1166	1167
			
1168	1169	1155	1170
			
1049	1171	1172	1173

 FHL/FML/FSL

Standarta krāsas

			
1016	1274	1259	1282

Dizaina krāsas

			
1276	1277	1278	1279
			
1280	1281	1256	1275
			
1283	1284	1285	1286

 PAL

Standarta krāsas

	
7001	7057

## INSEKTU TĪKLS

		<b>A</b>						
		0-438 mm	439-530 mm	531-640 mm	641-760 mm	761-922 mm	923-1120 mm	1121-1285 mm
<b>B</b>	0-1600 mm	ZIL BK04	ZIL CK02	ZIL FK08	ZIL MK06	ZIL PK25	ZIL SK06	ZIL UK04
		380,49 <b>468,00</b>	352,85 <b>434,00</b>	464,23 <b>571,00</b>	464,23 <b>571,00</b>	478,05 <b>588,00</b>	580,49 <b>714,00</b>	594,31 <b>731,00</b>
1601-2000 mm			ZIL CK06	ZIL FK08	ZIL MK06	ZIL PK06	ZIL SK06	ZIL UK10
		-	417,89 <b>514,00</b>	464,23 <b>571,00</b>	464,23 <b>571,00</b>	510,57 <b>628,00</b>	580,49 <b>714,00</b>	715,45 <b>880,00</b>
2001-2400 mm				ZIL FK08	ZIL MK10	ZIL PK10	ZIL SK10	ZIL UK10
		-	-	464,23 <b>571,00</b>	556,91 <b>685,00</b>	589,43 <b>725,00</b>	673,17 <b>828,00</b>	715,45 <b>880,00</b>

Insektu tīkli ir piemēroti šī brīža un iepriekšējās paaudzes VELUX jumta logiem.

Insektu tīkla izmēru kodi atšķiras no logu izmēru kodiem, jo tie ir uzstādīti pie sienas, nevis uz loga rāmja. Tāpēc, lai pasūtītu pareiza izmēra insektu tīklu, jānomēra loga ailes platums un augstums.

### Nosakiet pareizo izmēru:

Izmēriet iekšējās sienas platumu (A) un augstumu (B), lai cenu tabulā atrastu sava insektu tīkla izmēra kodu un cenu. Ja jumts ir divi augstumi (B) vai augstumi virs 2400 mm – nepieciešami divi insektu tīkli un viens savienošanas komplekts ZOZ 157 SWL.

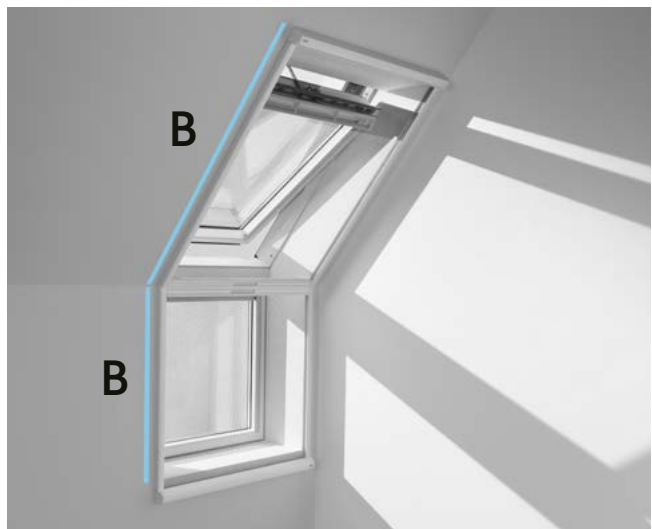
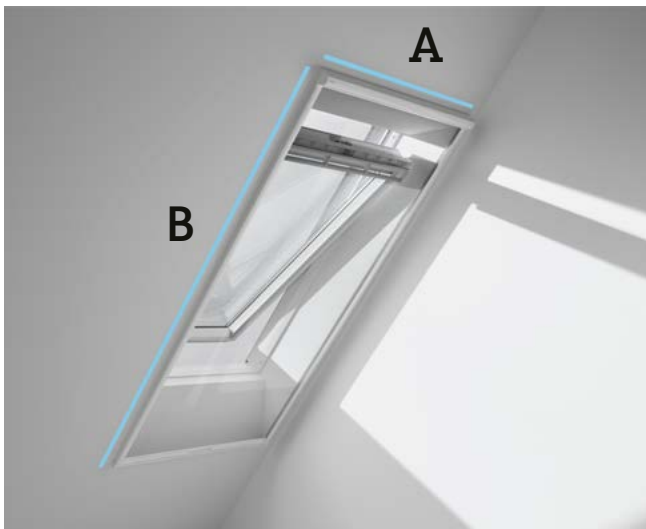

Cenas bez PVN, Euro  
Cenas ar PVN, Euro

MK04 PK04 SK04

### AIKSARDZĪBA PRET KARSTUMU GDL JUMTA BALKONIEM

MAD	Manuāla	Saulessargs VELUX jumta balkona GDL zemākajam loga elementam	5060	95,87 <b>116,00</b>	104,13 <b>126,00</b>	113,22 <b>137,00</b>
-----	---------	--	------	------------------------	-------------------------	-------------------------

MAD saulesargi ir paredzēti GDL jumta balkona apakšējai daļai. Augšējai daļai ir nepieciešams iegādāties saulesargu MHL.

Cenas bez PVN, Euro  
Cenas ar PVN, Euro

MK34 PK34 SK34 UK34

### AIKSARDZĪBA PRET KARSTUMU GIL/GIU NEVERAMAJIEM LOGA ELEMENTIEM

MAG	Manuāla	Saulessargs slīpajam loga elementam GIL/GIU	5060	93,39 <b>113,00</b>	106,61 <b>129,00</b>	120,66 <b>146,00</b>	128,93 <b>156,00</b>
-----	---------	---	------	------------------------	-------------------------	-------------------------	-------------------------

MAG saulesargi ir paredzēti GIL/GIU slīpajiem loga elementiem. Augšējai daļai ir nepieciešams iegādāties saulesargu MHL.

Cenas bez PVN, Euro  
Cenas ar PVN, Euro

FFKF06 FFKF08

### AIKSARDZĪBA PRET KARSTUMU JUMTA LOGIEM TRĪS VIENĀ

SLS	Solāra	Ruļļveida slēgi VELUX jumta logiem trīs vienā	0000	1 626,45 <b>1 968,00</b>	1 693,38 <b>2 049,00</b>
SSS	Solāra	Mīkstie slēgi VELUX jumta logiem trīs vienā	0000	1 103,31 <b>1 335,00</b>	1 150,41 <b>1 392,00</b>
MSLS	Solāra	Saulessargi VELUX jumta logiem trīs vienā	5060	870,24 <b>1 053,00</b>	907,44 <b>1 098,00</b>

-90€

Izmēru kods Rāmja izmērs, cm	FK04 66x98	FK06 66x118	FK08 66x140	MK04 78x98	MK06 78x118	MK08 78x140	MK10 78x160	PK06 94x118	PK08 94x140	PK10 94x160	SK06 114x118	SK08 114x140	UK08 134x140
---------------------------------	---------------	----------------	----------------	---------------	----------------	----------------	----------------	----------------	----------------	----------------	-----------------	-----------------	-----------------

### ĀRĒJĀ AIKSARDZĪBA PRET KARSTUMU KOMPLEKTOS

#### SOLĀRIE RUĻVEIDA SLĒGI + BAROŠANAS BLOKS

#### IZDEVĪGĀKA CENA, IEGĀDĀJOTIES KOMPLEKTU

SSL S30002	SSL 0000 + KSX	0000	746,28 <b>903,00</b>	768,60 <b>930,00</b>	790,91 <b>957,00</b>	762,81 <b>923,00</b>	790,91 <b>957,00</b>	819,01 <b>991,00</b>	847,93 <b>1 026,00</b>	836,36 <b>1 012,00</b>	870,25 <b>1 053,00</b>	904,13 <b>1 094,00</b>	881,82 <b>1 067,00</b>	926,45 <b>1 121,00</b>	982,64 <b>1 189,00</b>
---------------	----------------------	------	-------------------------	-------------------------	-------------------------	-------------------------	-------------------------	-------------------------	---------------------------	---------------------------	---------------------------	---------------------------	---------------------------	---------------------------	---------------------------

#### MĪKSTIE SLĒGI AR SOLĀRO VADĪBU + BAROŠANAS BLOKS

#### IZDEVĪGĀKA CENA, IEGĀDĀJOTIES KOMPLEKTU

SSS S30001	SSS 0000 + KSX	0000	504,96 <b>611,00</b>	516,53 <b>625,00</b>	528,93 <b>640,00</b>	514,05 <b>622,00</b>	528,93 <b>640,00</b>	543,80 <b>658,00</b>	559,50 <b>677,00</b>	552,89 <b>669,00</b>	571,07 <b>691,00</b>	589,26 <b>713,00</b>	577,69 <b>699,00</b>	601,65 <b>728,00</b>	631,40 <b>764,00</b>
---------------	----------------------	------	-------------------------	-------------------------	-------------------------	-------------------------	-------------------------	-------------------------	-------------------------	-------------------------	-------------------------	-------------------------	-------------------------	-------------------------	-------------------------

<b>Jumta logiem, kuri ražoti no 2014. gada</b>											
<b>Loga kods</b>	CK02	CK04	CK06	FK04	FK06	FK08	MK04	MK06			
Slēgi	CK02	CK04	CK06	FK04	FK06	FK08	MK04	MK06			
Žalūzijas/saulessargs ar sliedēm	CK02	CK04	CK06	FK04	FK06	FK08	MK04	MK06			
Žalūzijas/saulessargs ar āķiem	CK00	CK00	CK00	FK00	FK00	FK00	MK00	MK00			
<b>Jumta logiem, kuri ražoti no 2003. līdz 2014. gadam</b>											
<b>Loga kods</b>	C02	C04	C06	F04	F06	F08	M04	M06			
Slēgi	CK02	CK04	CK06	FK04	FK06	FK08	MK04	MK06			
Žalūzijas/saulessargs ar sliedēm	C02	C04	C06	F04	F06	F08	M04	M06			
Žalūzijas/saulessargs ar āķiem	CK00	CK00	CK00	FK00	FK00	FK00	MK00	MK00			
<b>Jumta logiem, kuri ražoti no 1992. līdz 2003. gadam</b>											
<b>Loga kods</b>	102	104	-	204	206	-	304	306			
Slēgi	CK02	CK04	-	FK04	FK06	-	MK04	MK06			
Žalūzijas/saulessargs ar sliedēm	102	104	-	204	206	-	M04	M06			
Žalūzijas/saulessargs ar āķiem	100	100	-	200	200	-	MK00	MK00			
<b>Kods</b>	<b>Darbība</b>		<b>Krāsa</b>	<b>Loga rāmja izmērs (cm)</b>							
				55x78	55x98	55x118	66x98	66x118	66x140	78x98	78x118
				CK02	CK04	CK06	FK04	FK06	FK08	MK04	MK06
Cenas bez PVN, Euro											
Cenas ar PVN, Euro											

## AIKSARDZĪBA PRET KARSTUMU

Slēgi											
<b>SML</b>	Elektriska	Ruļļveida slēgi	0000	338,84 <b>410,00</b>	358,68 <b>434,00</b>	371,07 <b>449,00</b>	371,07 <b>449,00</b>	386,78 <b>468,00</b>	403,31 <b>488,00</b>	383,47 <b>464,00</b>	403,31 <b>488,00</b>
<b>SSL</b>	Solāra	Ruļļveida slēgi	0000	474,38 <b>574,00</b>	502,48 <b>608,00</b>	519,83 <b>629,00</b>	519,83 <b>629,00</b>	542,15 <b>656,00</b>	564,46 <b>683,00</b>	536,36 <b>649,00</b>	564,46 <b>683,00</b>
<b>SMG</b>	Elektriska	Ruļļveida slēgi VELUX jumta logam, kas kombinēts ar VELUX slīpo loga elementu GIL/GIU	0000	-	-	-	816,53 <b>988,00</b>	852,07 <b>1 031,00</b>	887,60 <b>1 074,00</b>	842,98 <b>1 020,00</b>	887,60 <b>1 074,00</b>
<b>SMH</b>	Elektriska	Ruļļveida slēgi, kas paredzēti elektriskajam VELUX jumta logam GPU	0000	-	-	-	-	542,15 <b>656,00</b>	564,46 <b>683,00</b>	-	564,46 <b>683,00</b>
Mīkstie slēgi											
<b>SSS</b>	Solāra	Mīkstie slēgi	0000	253,72 <b>307,00</b>	269,42 <b>326,00</b>	278,51 <b>337,00</b>	278,51 <b>337,00</b>	290,08 <b>351,00</b>	302,48 <b>366,00</b>	287,60 <b>348,00</b>	302,48 <b>366,00</b>
Saulessargs, manuāli vadāms											
<b>MHL</b>	Manuāla	Saulessargs	5060		48,76 <b>59,00</b>			56,20 <b>68,00</b>		60,33 <b>73,00</b>	
<b>MIE</b>	Manuāla	Saulessargs vertikālajam loga elementam VFE	5060		-			-		100,83 <b>122,00</b>	
Saulessargs, ar tālvadības pulti vadāms											
<b>MML</b>	Elektriska	Saulessargs	5060	223,97 <b>271,00</b>	237,19 <b>287,00</b>	244,63 <b>296,00</b>	244,63 <b>296,00</b>	255,37 <b>309,00</b>	266,12 <b>322,00</b>	252,89 <b>306,00</b>	266,12 <b>322,00</b>
<b>MSL</b>	Solāra	Saulessargs	5060	253,72 <b>307,00</b>	269,42 <b>326,00</b>	278,51 <b>337,00</b>	278,51 <b>337,00</b>	290,08 <b>351,00</b>	302,48 <b>366,00</b>	287,60 <b>348,00</b>	302,48 <b>366,00</b>

Visi saulesargi un žalūzijas ir piemēroti šī brīža un iepriekšējās paaudzes VELUX jumta logiem. Vienmēr pasūtiet aksesuārus pēc jumta loga koda.

Pašreizējās paaudzes jumta logu izmēra kodā ir burts K, piemēram, MK06, iepriekšējās paaudzes jumta logs bez burta K ir tādā pašā izmērā, piemēram, M06.

Lai pasūtītu slēgus un žalūzijas jumta logiem, kas iegādāti pirms 2002. gada, lūdzam sazināties ar klientu servisu.

Visām elektriskajām darbināmām žalūzijām un slēgiem, kas iegādāti no 01.07.2023, ir 5 gadu garantija.

MHL saulesargs nav saderīgs ar KMG/KSX papildu motora bloku. Un nav uzstādāms jumta logam ar tālvadību.

Elektriskie vadāmie piederumi ir paredzēti savienošanai ar GGL/GGU elektriskajiem jumta logiem vai KUX 110 vadības bloku.

MML/MSL saulesargus logu kombinācijās var uzstādīt tikai, ja logi atrodas 250 mm attālumā viens virs otra un vismaz 18 mm attālumā, ja tie atrodas blakus.

SML/SSL (SMH) slēgus logu kombinācijās vienu virs otra var uzstādīt tikai, ja logi atrodas 250 (300) mm attālumā viens virs otra un vismaz 100 mm attālumā, ja tie atrodas blakus.

SSS mīkstos slēgus logu kombinācijās var uzstādīt tikai, ja logi atrodas 250 mm attālumā viens virs otra un vismaz 18 mm attālumā, ja tie atrodas blakus.

	MK08	MK10	MK12	PK06	PK08	PK10	SK06	SK08	SK10	UK04	UK08	UK10
	MK08	MK10	MK12	PK06	PK08	PK10	SK06	SK08	SK10	UK04	UK08	UK10
	MK08	MK10	MK12	PK06	PK08	PK10	SK06	SK08	SK10	UK04	UK08	UK10
	MK00	MK00	MK12	PK00	PK00	PK00	SK00	SK00	SK00	UK00	UK00	UK00

	M08	M10	M12	P06	P08	P10	S06	S08	S10	U04	U08	U10
	MK08	MK10	MK12	PK06	PK08	PK10	SK06	SK08	SK10	UK04	UK08	UK10
	M08	M10	M12	P06	P08	P10	S06	S08	S10	U04	U08	U10
	MK00	MK00	MK12	PK00	PK00	PK00	SK00	SK00	SK10	UK00	UK00	UK00

	308	310	-	406	408	410	606	608	610	804	808	810
	MK08	MK10	-	PK06	PK08	PK10	SK06	SK08	SK10	UK04	UK08	UK10
	M08	M10	-	P06	P08	P10	S06	S08	S10	U04	U08	U10
	MK00	MK00	-	PK00	PK00	PK00	SK00	SK00	SK00	UK00	UK00	UK00

	78x140	78x160	78x180	94x118	94x140	94x160	114x118	114x140	114x160	134x98	134x140	134x160
	MK08	MK10	MK12	PK06	PK08	PK10	SK06	SK08	SK10	UK04	UK08	UK10

	423,14 <b>512,00</b>	443,80 <b>537,00</b>	504,13 <b>610,00</b>	435,54 <b>527,00</b>	459,50 <b>556,00</b>	484,30 <b>586,00</b>	467,77 <b>566,00</b>	500,00 <b>605,00</b>	523,97 <b>634,00</b>	463,64 <b>561,00</b>	540,50 <b>654,00</b>	580,99 <b>703,00</b>
--	-------------------------	-------------------------	-------------------------	-------------------------	-------------------------	-------------------------	-------------------------	-------------------------	-------------------------	-------------------------	-------------------------	-------------------------

	592,56 <b>717,00</b>	621,49 <b>752,00</b>	705,79 <b>854,00</b>	609,92 <b>738,00</b>	643,80 <b>779,00</b>	677,69 <b>820,00</b>	655,37 <b>793,00</b>	700,00 <b>847,00</b>	733,88 <b>888,00</b>	649,59 <b>786,00</b>	756,20 <b>915,00</b>	813,22 <b>984,00</b>
--	-------------------------	-------------------------	-------------------------	-------------------------	-------------------------	-------------------------	-------------------------	-------------------------	-------------------------	-------------------------	-------------------------	-------------------------

	931,40 <b>1 127,00</b>	976,03 <b>1 181,00</b>	-	957,85 <b>1 159,00</b>	1 011,57 <b>1 224,00</b>	1 064,46 <b>1 288,00</b>	1 028,93 <b>1 245,00</b>	1 100,00 <b>1 331,00</b>	1 153,72 <b>1 396,00</b>	1 020,66 <b>1 235,00</b>	1 189,26 <b>1 439,00</b>	1 277,69 <b>1 546,00</b>
--	---------------------------	---------------------------	---	---------------------------	-----------------------------	-----------------------------	-----------------------------	-----------------------------	-----------------------------	-----------------------------	-----------------------------	-----------------------------

	592,56 <b>717,00</b>	-	-	609,92 <b>738,00</b>	643,80 <b>779,00</b>	-	655,37 <b>793,00</b>	700,00 <b>847,00</b>	-	-	-	-
--	-------------------------	---	---	-------------------------	-------------------------	---	-------------------------	-------------------------	---	---	---	---

	317,36 <b>384,00</b>	333,06 <b>403,00</b>	378,51 <b>458,00</b>	326,45 <b>395,00</b>	344,63 <b>417,00</b>	362,81 <b>439,00</b>	351,24 <b>425,00</b>	375,21 <b>454,00</b>	393,39 <b>476,00</b>	347,93 <b>421,00</b>	404,96 <b>490,00</b>	435,54 <b>527,00</b>
--	-------------------------	-------------------------	-------------------------	-------------------------	-------------------------	-------------------------	-------------------------	-------------------------	-------------------------	-------------------------	-------------------------	-------------------------

	60,33 <b>73,00</b>			70,25 <b>85,00</b>			77,69 <b>94,00</b>				-	
--	-----------------------	--	--	-----------------------	--	--	-----------------------	--	--	--	---	--

	100,83 <b>122,00</b>			117,36 <b>142,00</b>			129,75 <b>157,00</b>				141,32 <b>171,00</b>	
--	-------------------------	--	--	-------------------------	--	--	-------------------------	--	--	--	-------------------------	--

	279,34 <b>338,00</b>	292,56 <b>354,00</b>	333,06 <b>403,00</b>	287,60 <b>348,00</b>	303,31 <b>367,00</b>	319,01 <b>386,00</b>	309,09 <b>374,00</b>	329,75 <b>399,00</b>	346,28 <b>419,00</b>	305,79 <b>370,00</b>	357,02 <b>432,00</b>	383,47 <b>464,00</b>
--	-------------------------	-------------------------	-------------------------	-------------------------	-------------------------	-------------------------	-------------------------	-------------------------	-------------------------	-------------------------	-------------------------	-------------------------

	317,36 <b>384,00</b>	333,06 <b>403,00</b>	378,51 <b>458,00</b>	326,45 <b>395,00</b>	344,63 <b>417,00</b>	362,81 <b>439,00</b>	351,24 <b>425,00</b>	375,21 <b>454,00</b>	393,39 <b>476,00</b>	347,93 <b>421,00</b>	404,96 <b>490,00</b>	435,54 <b>527,00</b>
--	-------------------------	-------------------------	-------------------------	-------------------------	-------------------------	-------------------------	-------------------------	-------------------------	-------------------------	-------------------------	-------------------------	-------------------------



Cenas bez PVN, Euro  
Cenas ar PVN, Euro



CK04  
55x98



MK04  
78x98



MK06  
78x118



MK08  
78x140



PK04  
94x98



SK06  
114x118

### JUMTA LOGI UN PIESLĒGUMI NELIELAM JUMTA SLĪPUMAM (10°-20°)

W/(m² K) Iebūvēšanas  
slīpums

				CK04 55x98	MK04 78x98	MK06 78x118	MK08 78x140	PK04 94x98	SK06 114x118
<b>GBL 2015</b>	Verams ar roku, rokturis augšā, priedes koks, apstrādāts ar trīskāršu pārklājumu, balti krāsots, divkameru stikla pakete	1.1	10-20	413,22 <b>500,00</b>	469,42 <b>568,00</b>	510,74 <b>618,00</b>	546,28 <b>661,00</b>	535,54 <b>648,00</b>	628,10 <b>760,00</b>

Ņemiet vērā! Tikai jumta logs GBL 2015 komplektā ar pieslēgumu EDG nodrošina pareizu, ūdensnecaurlaidīgu un ciešu iebūvēšanu zem 15° jumta slīpuma.

Cenas bez PVN, Euro  
Cenas ar PVN, Euro

Izmērs (cm)



CK04  
55x98



MK04  
78x98



MK06  
78x118



MK08  
78x140



PK04  
94x98



SK06  
114x118

### PIESLĒGUMI NELIELAM JUMTA SLĪPUMAM (10°-20°) AR PROFILĒTU SEGUMU (LĪDZ 120 MM)

Iebūvēšanas  
slīpums









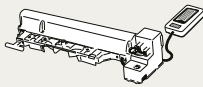
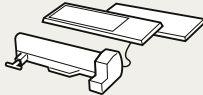

				CK04 55x98	MK04 78x98	MK06 78x118	MK08 78x140	PK04 94x98	SK06 114x118
<b>EDG 1000</b>	Pieslēguma komplekts EDG ar BFX, viena jumta loga GBL iebūvēšanai	10-20	128,10 <b>155,00</b>	143,80 <b>174,00</b>	151,24 <b>183,00</b>	160,33 <b>194,00</b>	161,16 <b>195,00</b>	178,51 <b>216,00</b>	
<b>EDG 1000U</b>	Pieslēguma komplekts EDG ar BFX, viena jumta loga GBL iebūvēšanai betona jumtā	10-20	128,10 <b>155,00</b>	143,80 <b>174,00</b>	151,24 <b>183,00</b>	160,33 <b>194,00</b>	161,16 <b>195,00</b>	178,51 <b>216,00</b>	
<b>EDG 2000</b>	Pieslēguma komplekts EDG ar BDx, viena jumta loga GBL iebūvēšanai	10-20	149,59 <b>181,00</b>	166,94 <b>202,00</b>	175,21 <b>212,00</b>	185,95 <b>225,00</b>	187,60 <b>227,00</b>	207,44 <b>251,00</b>	
<b>EDG 2000U</b>	Pieslēguma komplekts EDG ar BDx, viena jumta loga GBL iebūvēšanai betona jumtā	10-20	149,59 <b>181,00</b>	166,94 <b>202,00</b>	175,21 <b>212,00</b>	185,95 <b>225,00</b>	187,60 <b>227,00</b>	207,44 <b>251,00</b>	

Komplektācijā iekļauta pieslēguma augšējā daļa ar blīvējumu, divas sānu daļas ar blīvējumiem, divas ārējās sānu uzlikas, viena ārējā uzlika loga apakšai, viena pieslēguma apakšējā daļa, difūzijas membrāna un drenāžas noteka. Pieslēguma apakšējā detaļa ir pielāgojama jumta segumam.

# ELEKTRISKIE PRODUKTI

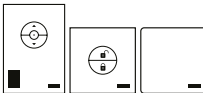
Cenas bez PVN, Eiro

Cenas ar PVN, Eiro

VIEDĀS MĀJAS KONTROLE		
<b>KMG 100K</b>	Elektrisks motors jumta logiem, kas ražoti pēc 2014. gada	 223,97 <b>271,00</b>
<b>KMG 100</b>	Elektrisks motors jumta logiem, kas ražoti pirms 2014. gada	223,97 <b>271,00</b>
<b>KSX 100K WW</b>	Solārs motors jumta logiem, kas ražoti pēc 2014. gada	 300,83 <b>364,00</b>
<b>KSX 100</b>	Solārs motors jumta logiem, kas ražoti pirms 2014. gada	300,83 <b>364,00</b>
<b>KUX 110 EU</b>	Elektriskais barošanas bloks	77,69 <b>94,00</b>
<b>KLI 310</b>	Tālvadības produkta vadības slēdzis	 27,27 <b>33,00</b>
<b>KLI 311</b>	Vadības slēdzis jumta logiem	 27,27 <b>33,00</b>
<b>KLI 312</b>	Vadības slēdzis žalūzijām	 27,27 <b>33,00</b>
<b>KLI 313</b>	Vadības slēdzis slēgļiem un saulesargiem	 27,27 <b>33,00</b>
<b>KLR 300</b>	VELUX Touch	 104,96 <b>127,00</b>
<b>KIG 300</b>	VELUX App Control	 100,00 <b>121,00</b>
<b>KIX 300</b>	VELUX ACTIVE iekštelpu klimata kontrole	 199,17 <b>241,00</b>
<b>KLN 300</b>	VELUX ACTIVE vadības slēdzis	 44,63 <b>54,00</b>
<b>KLF 050</b>	Elektriskais vadības bloks	 48,76 <b>59,00</b>
<b>KLB 100</b>	Elektrisks akumulators	 238,84 <b>289,00</b>

Lai jaunākās paaudzes VELUX jumta logus, kas verami ar roku, pārveidotu par elektriski veramiem logiem, jāizvēlas elektriskais vadības bloks KMG 100K + vadības sistēma KUX 110 EU vai solārās vadības sistēma KSX 100K.

KMG un KSX motora bloki ietver arī KLI sienas slēdzi un lietus sensoru. Šie komplekti nav saderīgi ar CK02 izmēra un mazākiem logiem.

Tālvadības žalūziju uzstādīšanas gadījumā DML/RML/FML/FMC uz manuāli vadāmiem jumta logiem vai logiem ar KMG motoru vienmēr ir nepieciešams pasūtīt adapteri ZOZ 241/243. Izvēlieties adaptera veidu atbilstoši VELUX jumta loga paaudzei.

KLF 200 interfeiss nodrošina savienojumu ar ārēju sistēmu un spēj kontrolēt līdz 200 motorizētiem produktiem, kas izvietoti mājā, un ne vairāk kā 5 grupas.

# PRODUKTI VELUX JUMTA LOGU UZTURĒŠANAI UN UZLABOŠANAI

## NOMAIŅAS STIKLA PAKETES

Nomainas stikla paketē IPL ir iekļauta izolēta stikla pakete, kas tiek piegādāta salokāmā kastē ar EPS, kas uzstādīts uz paketes aizsardzībai. Kopā ar stikla paketi tiek piegādāts arī uzstādīšanai nepieciešamie materiāli: skrūves, butils un instrukcija.

Siklojuma variants	Piemērots loga paaudzei	Veids	Ug	Biezums								
<b>Jumta logu paaudzei V21 (ražoti līdz 2014. gadam)</b>					<b>C02</b>	<b>C04</b>	<b>C06</b>	<b>F04</b>	<b>F06</b>	<b>F08</b>	<b>M04</b>	
IPL 0059	V21	Viena kamera	1,1	23.8 mm	82,64 <b>100,00</b>	91,74 <b>111,00</b>	96,69 <b>117,00</b>	99,17 <b>120,00</b>	104,13 <b>126,00</b>	115,70 <b>140,00</b>	110,74 <b>134,00</b>	
IPL 0073G	V21	Viena kamera	1,1	24.4 mm	99,17 <b>120,00</b>	109,92 <b>133,00</b>	115,70 <b>140,00</b>	119,01 <b>144,00</b>	125,62 <b>152,00</b>	138,84 <b>168,00</b>	133,06 <b>161,00</b>	
<b>Jumta logu paaudzei V22 (pieejami šobrīd)</b>					<b>CK02</b>	<b>CK04</b>	<b>CK06</b>	<b>FK04</b>	<b>FK06</b>	<b>FK08</b>	<b>MK04</b>	
IPL 0050	V22	Viena kamera	1,0	23.8 mm	82,64 <b>100,00</b>	91,74 <b>111,00</b>	96,69 <b>117,00</b>	99,17 <b>120,00</b>	104,13 <b>126,00</b>	115,70 <b>140,00</b>	110,74 <b>134,00</b>	
IPL 0061	V22	Divas kameras	0,6	38.6 mm	115,70 <b>140,00</b>	128,10 <b>155,00</b>	- -	138,84 <b>168,00</b>	146,28 <b>177,00</b>	161,98 <b>196,00</b>	155,37 <b>188,00</b>	
IPL 0068	V22	Divas kameras	0,7	37.1 mm	128,10 <b>155,00</b>	142,15 <b>172,00</b>	149,59 <b>181,00</b>	153,72 <b>186,00</b>	161,98 <b>196,00</b>	179,34 <b>217,00</b>	171,90 <b>208,00</b>	

Ja nepieciešams cits stikla paketes modelis, kas nav minēts augstāk esošajā tabulā, vai arī nepieciešams mainīt stikla paketes biežumu, lūdzu, sazinieties ar VELUX klientu servisu, lai noskaidrotu produkta pieejamību un cenu.

Cenas bez PVN, Euro  
Cenas ar PVN, Euro

Izmērs (cm) CK00 55x+++ FK00 66x+++ MK00 78x+++ PK00 94x+++ SK00 114x+++ UK00 134x+++

## KOMPLEKTI AIZSARDZĪBAI PRET SNIEGU UN LEDU

Iebūvēšanas  
slīpums

ZIS 0000	Sniega un ledus servisa komplektu var uzstādīt uz jau iebūvēta jumta loga. Komplekts sastāv no blīvēm, speciāla apakšējā rāmja pārsega un noslēgtām skrūvēm. Šie komponenti padara jumta logu izturīgāku pret sakrājušos ledu un sniegu uz loga un ekstremāliem laikapstākļiem. Piemērots tikai logiem ar divkammeru stikla paketi un tikai sarkanā līmeņa iebūvēšanai.	-	69,42 <b>84,00</b>	69,42 <b>84,00</b>	69,42 <b>84,00</b>	69,42 <b>84,00</b>	69,42 <b>84,00</b>	69,42 <b>84,00</b>
----------	---	---	-----------------------	-----------------------	-----------------------	-----------------------	-----------------------	-----------------------



	M06	M08	M10	P06	P08	P10	S06	S08	S10	U04	U08	U10
	127,27 <b>154,00</b>	137,19 <b>166,00</b>	152,89 <b>185,00</b>	137,19 <b>166,00</b>	146,28 <b>177,00</b>	171,90 <b>208,00</b>	165,29 <b>200,00</b>	169,42 <b>205,00</b>	178,51 <b>216,00</b>	165,29 <b>200,00</b>	193,39 <b>234,00</b>	223,14 <b>270,00</b>
	152,89 <b>185,00</b>	165,29 <b>200,00</b>	183,47 <b>222,00</b>	165,29 <b>200,00</b>	176,03 <b>213,00</b>	205,79 <b>249,00</b>	198,35 <b>240,00</b>	203,31 <b>246,00</b>	214,05 <b>259,00</b>	198,35 <b>240,00</b>	232,23 <b>281,00</b>	266,94 <b>323,00</b>
	MK06	MK08	MK10	PK06	PK08	PK10	SK06	SK08	SK10	UK04	UK08	UK10
	127,27 <b>154,00</b>	137,19 <b>166,00</b>	152,89 <b>185,00</b>	137,19 <b>166,00</b>	146,28 <b>177,00</b>	171,90 <b>208,00</b>	165,29 <b>200,00</b>	169,42 <b>205,00</b>	178,51 <b>216,00</b>	165,29 <b>200,00</b>	193,39 <b>234,00</b>	223,14 <b>270,00</b>
	178,51 <b>216,00</b>	192,56 <b>233,00</b>	214,05 <b>259,00</b>	192,56 <b>233,00</b>	204,96 <b>248,00</b>	- <b>-</b>	231,40 <b>280,00</b>	237,19 <b>287,00</b>	- <b>-</b>	- <b>-</b>	- <b>-</b>	- <b>-</b>
	197,52 <b>239,00</b>	213,22 <b>258,00</b>	236,36 <b>286,00</b>	213,22 <b>258,00</b>	227,27 <b>275,00</b>	266,12 <b>322,00</b>	256,20 <b>310,00</b>	261,98 <b>317,00</b>	276,03 <b>334,00</b>	256,20 <b>310,00</b>	300,00 <b>363,00</b>	345,45 <b>418,00</b>

#### JUMTA LOGU APKOPE

<b>ZZZ 129KL</b>	Remontlaka jumta logiem ar poliuretāna pārklājumu	Šis profesionālais remonta komplekts paredzēts VELUX jumta logu ar poliuretāna pārklājumu virsmas skrāpējumu un traipu labošanai. Lai jūsu logi izskatās pēc iespējas labāk, efektīvi nosedzot virsmas bojājumus. Komplektā ir viena pudele (220ml) poliuretāna remontlakas.	18,18 <b>22,00</b>
<b>ZZZ 176KL</b>	Remontlaka jumta logiem ar koka apdari	Šis profesionālais remonta komplekts paredzēts bojātas virsmas lakas labošanai uz VELUX jumta logiem ar koka apdari. Komplektā ir viena pudele (220ml) caurspīdīgas lakas kokam.	20,66 <b>25,00</b>
<b>ZZZ 133KL</b>	Akrila pildviela iespaidumu labošanai logos ar poliuretāna pārklājumu	Šis profesionālais remonta komplekts paredzēts skrāpējumu, iedobumu un citu virsmas bojājumu aizpildīšanai VELUX jumta logiem ar baltu poliuretāna pārklājumu. Ota nav iekļauta komplektā.	26,45 <b>32,00</b>
<b>ZZZ 220/220K</b>	Servisa komplekts VELUX jumta logu apkopei	Kastē ietilpst: <ul style="list-style-type: none"> <li>· Instrukcija</li> <li>· Viena smilšpapīra loksne</li> <li>· Viens 3 m ventilācijas rullis (3,5 x 38 mm)</li> <li>· Viens 3 m gaisa filtra rullis (20 x 20 mm)</li> <li>· Viena smērvielas tūbiņa</li> <li>· Viens atvienošanas instruments</li> </ul> Ar komplektu var veikt apkopi 2 līdz 5 VELUX jumta logiem atkarībā no izmēra.	28,93 <b>35,00</b>

# GAISMAS TUNEĻI

Cenas bez PVN, Euro  
Cenas ar PVN, Euro

Nominālais diametrs (mm)  
Izmērs (cm)

OK10  
250  
37x37

OK14  
350  
47x47

OK14  
350  
60x60

## GAISMAS TUNEĻI

### GAISMAS TUNEĻI AR FISKĒTU CAURULI

TLR 2010	Gaismas tunelis TLR slīpam jumtam ar profilētu segumu, fiksēta caurule, 25 cm	358,68 <b>434,00</b>	-	-
TWR 2010	VELUX gaismas tunelis TWR slīpam jumtam ar profilētu segumu, fiksēta caurule, 25 cm	358,68 <b>434,00</b>	-	-
TLR 2010	Gaismas tunelis TLR slīpam jumtam ar profilētu segumu, fiksēta caurule, 35 cm	-	412,40 <b>499,00</b>	-
TWR 2010	VELUX gaismas tunelis TWR slīpam jumtam ar profilētu segumu, fiksēta caurule, 35 cm	-	412,40 <b>499,00</b>	-
TCR 0010	Gaismas tunelis TCR plakanam jumtam, fiksēta caurule, 35 cm	-	-	532,23 <b>644,00</b>

### GAISMAS TUNEĻI AR GOFRĒTU CAURULI

TLF 2010	VELUX gaismas tunelis TLF slīpam jumtam ar plakanu segumu, gofrēta caurule, 35 cm	-	329,75 <b>399,00</b>	-
TWF 2010	Gaismas tunelis TWF slīpam jumtam ar profilētu segumu, gofrēta caurule, 35 cm	-	329,75 <b>399,00</b>	-
TCF 0010	Gaismas tunelis TCF plakanam jumtam, gofrēta caurule, 35 cm	-	-	358,68 <b>434,00</b>

### Hidroizolācijas komplekts

BFX 1000	Hidroizolācijas membrāna gaismas tuneļiem	57,85 <b>70,00</b>	57,85 <b>70,00</b>	-
----------	---	-----------------------	-----------------------	---

Cenas bez PVN, Euro  
Cenas ar PVN, Euro

OK10

OK14

### PAGARINĀJUMA ELEMENTI FIKSĒTĀM CAURULĒM

ZTR 0062	Fiksēts caurules pagarinājums gaismas tuneļiem, 62 cm	63,64 <b>77,00</b>	76,86 <b>93,00</b>
ZTR 0124	Fiksēts caurules pagarinājums gaismas tuneļiem, 124 cm	-	104,96 <b>127,00</b>

### UZLABOTAS ENERGOEFEKTIVITĀTES KOMPLEKTS

ZTB 2002	Energoefektivitātes komplekts gaismas tuneļiem	-	42,98 <b>52,00</b>
----------	--	---	-----------------------

Cenas bez PVN, Euro  
Cenas ar PVN, Euro

### PAGARINĀJUMA RĀMIS PLAKANĀ JUMTA GAISMAS TUNELIM

ZCE 0015	Paaugstinājuma rāmis gaismas tuneļiem TCF/TCR plakaniem jumtiem	156,20 <b>189,00</b>
----------	---	-------------------------

### APGAISMOJUMA KOMPLEKTS

ZTL ++	Apgaismojuma komplekts ZTL gaismas tuneļiem	76,86 <b>93,00</b>
--------	---	-----------------------

## GAISMAS TUNEĻI AR LAMPAS FUNKCIJU DIENAS UN NAKTS RISINĀJUMI

TCF 0010 + ZTL ++	TCF S00C01	408,26 <b>494,00</b>
TCR 0010P1 + TCR 0010P2 + ZTL ++	TCR S00C01	581,82 <b>704,00</b>
TLF 2010 + ZTL ++	TLF S00C01	379,34 <b>459,00</b>
TLR 2010 + ZTL ++	TLR S00C01	461,98 <b>559,00</b>
TWF 2010 + ZTL ++	TWF S00W01	379,34 <b>459,00</b>
TWR 2010 + ZTL ++	TWR S00W01	461,98 <b>559,00</b>

# AKSESUĀRI

Cenas bez PVN, Euro

**Cenas ar PVN, Euro**

## LOGU AKSESUĀRI

Papildus produkti ērtākai lietošanai un drošībai

<b>ZCZ 112</b>	Apkalpes stienis ir ideāli piemērots VELUX jumta logiem ar rokturi vērtnes apakšā, kas tiek uzstādīti neaizsniedzamā vietā. Stienis ir 120 cm garš.	52,89 <b>64,00</b>
<b>ZOZ 012K1</b>	Uzlabo aizsardzību, pievienojot pa centrālo asi veramajiem jumta logiem pretuzlaušanas slēdzeni. Tā novērš logu atvēršanu no iekšpuses bez atslēgas.	20,66 <b>25,00</b>
<b>ZOZ 095</b>	Adapteris neaizsniedzamu VELUX pa centrālo asi veramo jumta logu (GLU, GLL, GZL) vadībai ar apkalpes stienja palīdzību. Paredzēts vecā dizaina augšējām rokturim.	10,74 <b>13,00</b>
<b>ZZZ 181K2</b>	Apakšējais rokturis VELUX jumta logiem, kas verami pa centrālo asi un kuru izmēra kodā ir burts K.	28,10 <b>34,00</b>
<b>ZZZ 237</b>	Piestipriniet celtna āķus abās VELUX jumta loga pusēs, lai viegli, ātri un droši paceltu smagus jumta logus. Pēc piestiprināšanas var pieslēgt celtna pacelšanas siksnas un logu ātri un vienkārši pacelt līdz jumta atvēršanai. Celtna āķus var izmantot ar lielāko daļu VELUX jumta logu tipu līdz 120 kg.	421,49 <b>510,00</b>
<b>ZZZ 244</b>	Ar elastīgajām pārnēsāšanas siksnām divi cilvēki var droši nest lielas un smagas VELUX kastes bez papildu aprīkojuma. Siksnas var izmantot ar visiem VELUX jumta logiem, lai nodrošinātu ērtu pacelšanu un precīzu vadāmību pa šaurām ejām un kāpnēm.	66,12 <b>80,00</b>
<b>ZZZ 258</b>	Atkārtoti lietojamie VELUX rāmja aizsargi ir paredzēti, lai samazinātu bojājumu risku, atkārtoti uzstādot logu tā rāmī. Izgatavots no izturīgas gumijas, trīs aizsargu komplektu var uzstādīt uz jebkura VELUX jumta loga apakšējā un sānu rāmja, lai tas neradītu pēdas rāmī.	27,27 <b>33,00</b>

Cenas bez PVN, Euro

**Cenas ar PVN, Euro**

## ŽALŪZIJU UN SLĒĢU AKSESUĀRI

<b>ZCT 100</b>	Pagarinājums teleskopiskajam apkalpes stienim ZCT 200K, pievienojot tam 100 cm.	19,83 <b>24,00</b>
<b>ZCT 200K</b>	Teleskopiskais apkalpes stienis neaizsniedzamu VELUX pa centrālo asi veramo jumta logu un žalūziju vadībai. 100-180 cm garš. Izmantojot stieni žalūziju vadīšanai, jāpievieno adapteris ZOZ 085.	24,79 <b>30,00</b>
<b>ZCZ 080K</b>	Apkalpes stienis neaizsniedzamu VELUX pa centrālo asi veramo jumta logu un žalūziju vadībai. 80 cm garš. Izmantojot stieni žalūziju vadīšanai, jāpievieno adapteris ZOZ 085.	19,83 <b>24,00</b>
<b>ZOZ 040</b>	Adapteris apkalpes stienim, lai varētu vadīt neaizsniedzamas ruļļveida žalūzijas ar āķiem (RHL).	10,74 <b>13,00</b>
<b>ZOZ 085</b>	Adapteris apkalpes stienim, lai varētu vadīt neaizsniedzamas žalūzijas.	10,74 <b>13,00</b>
<b>ZOZ 157SWL</b>	Produkts divu insektu tīklu savienošanai specifiskas loga ailes gadījumā (skat. 58. lpp.)	19,83 <b>24,00</b>
<b>ZOZ ++</b>	Adaptēra plātne āra produktiem aizsardzībai pret sauli, kas ļauj darbināt žalūzijas un saulesargus jumta logiem ar solāro vadību GGL un GGU	50,41 <b>61,00</b>
<b>ZOZ 217</b>	Projekcijas sviras tiek izmantotas papildu ventilācijai un gaismas pieplūdei, kad ruļļveida slēgi ir nolaisti. Tikai manuālajiem VELUX jumta logiem no 2000. gada (izņemot GTU/GTL).	38,02 <b>46,00</b>
<b>ZOZ 229</b>	Īpaši kronšteini, kas ļauj uzstādīt saulesargus MML-SA un MSL-SA uz VELUX elektriskā loga GPU.	42,15 <b>51,00</b>
<b>ZOZ 230</b>	Žalūziju montāžas kronšteini nepieciešami logiem, kas ražoti pirms 2012. gada.	4,96 <b>6,00</b>
<b>ZOZ 238</b>	ZOZ 238 ir komplekts ārējā aksesuāra SSS-SA, MSL-SA, MML-SA uzstādīšanai uz VELUX jumta logiem, kas ražoti pirms 2000. gada. ZOZ 238 nevar izmantot VELUX jumta logiem, kas ražoti pirms 1992. gada.	24,79 <b>30,00</b>
<b>ZOZ 241</b>	Kabeļu komplekts ir nepieciešams, lai VELUX elektriskās žalūzijas uzstādītu uz manuāli vadāmiem VELUX jumta logiem vai manuāli vadāmiem VELUX jumta logiem, kas ir modernizēti ar motoru. VELUX elektriskās žalūzijas var vadīt ar tālvadības pulti, lai nodrošinātu pilnīgu kontroli pār dabisko apgaismojumu istabā.	19,83 <b>24,00</b>
<b>ZOZ 243</b>	Kabeļu komplekts ir nepieciešams VELUX elektriskajām žalūzijām, kuras jāuzstāda vecākās paaudzes VELUX jumta logiem (VKI/VES/V21).	19,83 <b>24,00</b>
<b>ZOZ 246</b>	Izmanto, uzstādot ar saules enerģiju darbināmus slēgus un saulesargus (SSS vai MSL) uz maziem VELUX ar saules enerģiju darbināmiem jumta logiem (izmēri C un F).	55,37 <b>67,00</b>
<b>ZOZ 250</b>	Vads, ko izmanto solāri vadāmam saulesargam un mīkstajam slēgim (MSL/SSS) uzlādēšanai displejos	9,92 <b>12,00</b>
<b>ZOZ 253</b>	Uzstādīšanas komplekts ruļļveida žalūziju SML/SSL uzstādīšanai jumta logiem, kas ražoti pirms 2000. gada	23,97 <b>29,00</b>
<b>ZOZ 254</b>	Uzstādīšanas komplekts SSL/SML ruļļveida žalūziju SSL/SML uzstādīšanai jumta logiem, kas ražoti no 1942. līdz 2000. gadam	23,97 <b>29,00</b>

Ja tālvadības žalūzijas DML/RML/FML/FMC tiek uzstādītas uz manuāli vadāmiem jumta logiem vai logiem ar KMG motoru, tad vienmēr ir nepieciešams pasūtīt papildu adapteri ZOZ 241/243. Izvēlies adapteri atbilstoši VELUX jumta loga paaudzei.

# VIRSGAISMAS LOGI

Cenas bez PVN, Euro  
Cenas ar PVN, Euro

Izmērs (cm)\*

060060  
60x60

080080  
80x80

090060  
90x60

090090  
90x90

100100  
100x100

120090  
120x90

120120  
120x120

150080  
150x80

## JAUNĀS PAAUDZES VIRSGAISMAS LOGS AR IZLIEKTA STIKLA VIRSMU

Iebūvēšanas slīpums (minimālais) Iebūvēšanas slīpums (maksimālais)

### Virsmā

ISU 1093	Izliekta stikla virsmā virsgaismas logam	0	15	466,94 565,00	556,20 673,00	514,88 623,00	618,18 748,00	686,78 831,00	714,05 864,00	892,56 1 080,00	830,58 1 005,00
----------	--	---	----	------------------	------------------	------------------	------------------	------------------	------------------	--------------------	--------------------

Ūrc,ref300 W/(m<sup>2</sup>K)\*\* Arc,ref300 m<sup>2</sup>\*\*

### Pamatne

CFU 0020Q	Neverama pamatne, vienkameras stikla pakete	0,65	4,4	349,59 423,00	416,53 504,00	385,95 467,00	462,81 560,00	514,05 622,00	534,71 647,00	627,27 759,00	565,29 684,00
CFU 0025Q	Neverama pamatne, divkameru stikla pakete	0,55	4,4	454,55 550,00	541,32 655,00	500,83 606,00	601,65 728,00	668,60 809,00	695,04 841,00	814,88 986,00	734,71 889,00
CVU 0220Q	Elektriski verama pamatne, vienkameras stikla pakete	0,65	4,4	1 042,98 1 262,00	1 109,92 1 343,00	1 079,34 1 306,00	1 156,20 1 399,00	1 207,44 1 461,00	1 228,10 1 486,00	1 320,66 1 598,00	1 258,68 1 523,00
CVU 0225Q	Elektriski verama pamatne, divkameru stikla pakete	0,55	4,4	1 147,93 1 389,00	1 234,71 1 494,00	1 194,21 1 445,00	1 295,04 1 567,00	1 361,98 1 648,00	1 388,43 1 680,00	1 508,26 1 825,00	1 428,10 1 728,00
CVU 0320Q	Solāri verama pamatne, vienkameras stikla pakete	0,65	4,4	1 042,98 1 262,00	1 109,92 1 343,00	1 079,34 1 306,00	1 156,20 1 399,00	1 207,44 1 461,00	1 228,10 1 486,00	1 320,66 1 598,00	1 258,68 1 523,00
CVU 0325Q	Solāri verama pamatne, divkameru stikla pakete	0,55	4,4	1 147,93 1 389,00	1 234,71 1 494,00	1 194,21 1 445,00	1 295,04 1 567,00	1 361,98 1 648,00	1 388,43 1 680,00	1 508,26 1 825,00	1 428,10 1 728,00

### Iebūvēšanas piederumi

ZCU 0015	Paaugstinājums ar atloku, 15 cm, saderīgs ar virsgaismas logiem CVU un CFU	260,33 315,00	278,51 337,00	275,21 333,00	290,08 351,00	299,17 362,00	302,48 366,00	334,71 405,00	314,05 380,00
ZCU 1015	Paaugstinājums, 15 cm, bez atloka, saderīgs ar virsgaismas logiem CVU un CFU	233,88 283,00	250,41 303,00	247,93 300,00	261,16 316,00	269,42 326,00	271,90 329,00	301,65 365,00	282,64 342,00
ZZZ 210U	Nostiprināšanas komplekts virsgaismas logiem CVU/CFU	57,02 69,00	61,16 74,00	60,33 73,00	63,64 77,00	66,12 80,00	66,12 80,00	73,55 89,00	69,42 84,00
BBX 0000	Tvaika barjera virsgaismas logiem	21,49 26,00	23,14 28,00	23,14 28,00	23,97 29,00	24,79 30,00	24,79 30,00	28,10 34,00	26,45 32,00
LSF 2000	Ailes apdare virsgaismas logiem	268,60 325,00	287,60 348,00	294,21 356,00	307,44 372,00	326,45 395,00	319,83 387,00	345,45 418,00	329,75 399,00

\* Visiem taisnstūrveida izmēriem (ar elektrisko vai saules enerģiju) loga eņģes novietotas garākajā pusē.

\*\* Aprēķināts izmēram 120x120 cm ar 300 mm paaugstinājumu 0° jumta slīpumā.

	 150100 150x100	 150120 150x120	 150150 150x150	 200060 200x60	 200100 200x100
	906,61 <b>1 097,00</b>	1 064,46 <b>1 288,00</b>	1 235,54 <b>1 495,00</b>	940,50 <b>1 138,00</b>	1 297,52 <b>1 570,00</b>
	642,98 <b>778,00</b>	724,79 <b>877,00</b>	842,98 <b>1 020,00</b>	642,98 <b>778,00</b>	884,30 <b>1 070,00</b>
	835,54 <b>1 011,00</b>	942,15 <b>1 140,00</b>	1 095,87 <b>1 326,00</b>	835,54 <b>1 011,00</b>	1 149,59 <b>1 391,00</b>
	1 336,36 <b>1 617,00</b>	1 418,18 <b>1 716,00</b>	1 536,36 <b>1 859,00</b>	1 336,36 <b>1 617,00</b>	1 577,69 <b>1 909,00</b>
	1 528,93 <b>1 850,00</b>	1 635,54 <b>1 979,00</b>	1 789,26 <b>2 165,00</b>	1 528,93 <b>1 850,00</b>	1 842,98 <b>2 230,00</b>
	1 336,36 <b>1 617,00</b>	1 418,18 <b>1 716,00</b>	1 536,36 <b>1 859,00</b>	1 336,36 <b>1 617,00</b>	1 577,69 <b>1 909,00</b>
	1 528,93 <b>1 850,00</b>	1 635,54 <b>1 979,00</b>	1 789,26 <b>2 165,00</b>	1 528,93 <b>1 850,00</b>	1 842,98 <b>2 230,00</b>
	347,11 <b>420,00</b>	374,38 <b>453,00</b>	406,61 <b>492,00</b>	358,68 <b>434,00</b>	428,10 <b>518,00</b>
	312,40 <b>378,00</b>	336,36 <b>407,00</b>	366,12 <b>443,00</b>	323,14 <b>391,00</b>	385,12 <b>466,00</b>
	76,03 <b>92,00</b>	82,64 <b>100,00</b>	89,26 <b>108,00</b>	79,34 <b>96,00</b>	94,21 <b>114,00</b>
	28,93 <b>35,00</b>	28,93 <b>35,00</b>	29,75 <b>36,00</b>	28,93 <b>35,00</b>	32,23 <b>39,00</b>
	352,07 <b>426,00</b>	357,85 <b>433,00</b>	383,47 <b>464,00</b>	367,77 <b>445,00</b>	400,00 <b>484,00</b>

Cenas bez PVN, Euro  
Cenas ar PVN, Euro

Izmērs (cm)\*

060060  
60x60

080080  
80x80

090060  
90x60

090090  
90x90

100100  
100x100

120090  
120x90

120120  
120x120

150080  
150x80

## JAUNĀS PAAUDZES VIRSGAISMAS LOGS AR PLAKANA STIKLA VIRSMU

Iebūvēšanas slīpums (minimālais) Iebūvēšanas slīpums (maksimālais)

### Virsmā

ISU 2093	Plakana stikla virsmā	2	15	337,19 <b>408,00</b>	401,65 <b>486,00</b>	371,90 <b>450,00</b>	446,28 <b>540,00</b>	495,87 <b>600,00</b>	515,70 <b>624,00</b>	644,63 <b>780,00</b>	600,00 <b>726,00</b>
----------	-----------------------	---	----	-------------------------	-------------------------	-------------------------	-------------------------	-------------------------	-------------------------	-------------------------	-------------------------

Urc.ref300 W/(m<sup>2</sup>K)\*\* Arc.ref300 m<sup>2</sup>\*\*

### Pamatne

CFU 0020Q	Neverama pamatne, vienkameras stikla pakete	0.75	4.1	349,59 <b>423,00</b>	416,53 <b>504,00</b>	385,95 <b>467,00</b>	462,81 <b>560,00</b>	514,05 <b>622,00</b>	534,71 <b>647,00</b>	627,27 <b>759,00</b>	565,29 <b>684,00</b>
CFU 0025Q	Neverama pamatne, divkameru stikla pakete	0.60	4.1	454,55 <b>550,00</b>	541,32 <b>655,00</b>	500,83 <b>606,00</b>	601,65 <b>728,00</b>	668,60 <b>809,00</b>	695,04 <b>841,00</b>	814,88 <b>986,00</b>	734,71 <b>889,00</b>
CVU 0220Q	Elektriski verama pamatne, vienkameras stikla pakete	0.75	4.1	1 042,98 <b>1 262,00</b>	1 109,92 <b>1 343,00</b>	1 079,34 <b>1 306,00</b>	1 156,20 <b>1 399,00</b>	1 207,44 <b>1 461,00</b>	1 228,10 <b>1 486,00</b>	1 320,66 <b>1 598,00</b>	1 258,68 <b>1 523,00</b>
CVU 0225Q	Elektriski verama pamatne, divkameru stikla pakete	0.60	4.1	1 147,93 <b>1 389,00</b>	1 234,71 <b>1 494,00</b>	1 194,21 <b>1 445,00</b>	1 295,04 <b>1 567,00</b>	1 361,98 <b>1 648,00</b>	1 388,43 <b>1 680,00</b>	1 508,26 <b>1 825,00</b>	1 428,10 <b>1 728,00</b>
CVU 0320Q	Solāri verama pamatne, vienkameras stikla pakete	0.75	4.1	1 042,98 <b>1 262,00</b>	1 109,92 <b>1 343,00</b>	1 079,34 <b>1 306,00</b>	1 156,20 <b>1 399,00</b>	1 207,44 <b>1 461,00</b>	1 228,10 <b>1 486,00</b>	1 320,66 <b>1 598,00</b>	1 258,68 <b>1 523,00</b>
CVU 0325Q	Solāri verama pamatne, divkameru stikla pakete	0.60	4.1	1 147,93 <b>1 389,00</b>	1 234,71 <b>1 494,00</b>	1 194,21 <b>1 445,00</b>	1 295,04 <b>1 567,00</b>	1 361,98 <b>1 648,00</b>	1 388,43 <b>1 680,00</b>	1 508,26 <b>1 825,00</b>	1 428,10 <b>1 728,00</b>

### Iebūvēšanas piederumi

ZCU 0015	Paaugstinājums ar atloku, 16 cm, saderīgs ar virsgaismas logiem CVU un CFU	260,33 <b>315,00</b>	278,51 <b>337,00</b>	275,21 <b>333,00</b>	290,08 <b>351,00</b>	299,17 <b>362,00</b>	302,48 <b>366,00</b>	334,71 <b>405,00</b>	314,05 <b>380,00</b>
ZCU 1015	Paaugstinājums, 16 cm, bez atloka, saderīgs ar virsgaismas logiem CVU un CFU	233,88 <b>283,00</b>	250,41 <b>303,00</b>	247,93 <b>300,00</b>	261,16 <b>316,00</b>	269,42 <b>326,00</b>	271,90 <b>329,00</b>	301,65 <b>365,00</b>	282,64 <b>342,00</b>
ZZZ 210U	Nostiprināšanas komplekts virsgaismas logiem CVU/CFU	57,02 <b>69,00</b>	61,16 <b>74,00</b>	60,33 <b>73,00</b>	63,64 <b>77,00</b>	66,12 <b>80,00</b>	66,12 <b>80,00</b>	73,55 <b>89,00</b>	69,42 <b>84,00</b>
BBX 0000	Tvaika barjera virsgaismas logiem	21,49 <b>26,00</b>	23,14 <b>28,00</b>	23,14 <b>28,00</b>	23,97 <b>29,00</b>	24,79 <b>30,00</b>	24,79 <b>30,00</b>	28,10 <b>34,00</b>	26,45 <b>32,00</b>
LSF 2000	Ailes apdare virsgaismas logiem	268,60 <b>325,00</b>	287,60 <b>348,00</b>	294,21 <b>356,00</b>	307,44 <b>372,00</b>	326,45 <b>395,00</b>	319,83 <b>387,00</b>	345,45 <b>418,00</b>	329,75 <b>399,00</b>

\* Visiem taisnstūrveida izmēriem (ar elektrisko vai saules enerģiju) loga eņģes novietotas garākajā pusē.

\*\* Aprēķināts izmēram 120x120 cm ar 300 mm paaugstinājumu 0° jumta slīpumā.

Cenas bez PVN, Euro  
Cenas ar PVN, Euro

060060

080080

090060

090090

100100

120090

120120

150080

## ŽALŪZIJAS JAUNĀS PAAUDZES VIRSGAISMAS LOGIEM

DSU	Gaismu necaurļaidīgās žalūzijas, solārā vadība	318,18 <b>385,00</b>	332,23 <b>402,00</b>	324,79 <b>393,00</b>	338,84 <b>410,00</b>	346,28 <b>419,00</b>	352,89 <b>427,00</b>	359,50 <b>435,00</b>	356,20 <b>431,00</b>
MSU	Saulessargs, solārā vadība	318,18 <b>385,00</b>	332,23 <b>402,00</b>	324,79 <b>393,00</b>	338,84 <b>410,00</b>	346,28 <b>419,00</b>	352,89 <b>427,00</b>	359,50 <b>435,00</b>	356,20 <b>431,00</b>
ZIU	Insektu tīkls, manuālā vadība	79,34 <b>96,00</b>	82,64 <b>100,00</b>	80,99 <b>98,00</b>	85,12 <b>103,00</b>	86,78 <b>105,00</b>	88,43 <b>107,00</b>	90,08 <b>109,00</b>	89,26 <b>108,00</b>

Saulessargi un gaismu necaurļaidīgās žalūzijas ir novietotas jumta loga iekšpusē. Mēs iesakām uzstādīt aksesuārus jumta loga iebūvēšanas laikā. Produkti ir savienojami ar jaunās paaudzes CVU un CFU virsgaismas logiem ar plakānu un izliektu stiklu. Saulessargu un žalūzijas var kombinēt ar insektu tīklu. Nav iespējams apvienot saulessargu ar žalūziju

	 150100 150x100	 150120 150x120	 150150 150x150	 200060 200x60	 200100 200x100
	654,55 <b>792,00</b>	767,77 <b>929,00</b>	891,74 <b>1 079,00</b>	679,34 <b>822,00</b>	936,36 <b>1 133,00</b>
	642,98 <b>778,00</b>	724,79 <b>877,00</b>	842,98 <b>1 020,00</b>	642,98 <b>778,00</b>	884,30 <b>1 070,00</b>
	835,54 <b>1 011,00</b>	942,15 <b>1 140,00</b>	1 095,87 <b>1 326,00</b>	835,54 <b>1 011,00</b>	1 149,59 <b>1 391,00</b>
	1 336,36 <b>1 617,00</b>	1 418,18 <b>1 716,00</b>	1 536,36 <b>1 859,00</b>	1 336,36 <b>1 617,00</b>	1 577,69 <b>1 909,00</b>
	1 528,93 <b>1 850,00</b>	1 635,54 <b>1 979,00</b>	1 789,26 <b>2 165,00</b>	1 528,93 <b>1 850,00</b>	1 842,98 <b>2 230,00</b>
	1 336,36 <b>1 617,00</b>	1 418,18 <b>1 716,00</b>	1 536,36 <b>1 859,00</b>	1 336,36 <b>1 617,00</b>	1 577,69 <b>1 909,00</b>
	1 528,93 <b>1 850,00</b>	1 635,54 <b>1 979,00</b>	1 789,26 <b>2 165,00</b>	1 528,93 <b>1 850,00</b>	1 842,98 <b>2 230,00</b>
	347,11 <b>420,00</b>	374,38 <b>453,00</b>	406,61 <b>492,00</b>	358,68 <b>434,00</b>	428,10 <b>518,00</b>
	312,40 <b>378,00</b>	336,36 <b>407,00</b>	366,12 <b>443,00</b>	323,14 <b>391,00</b>	385,12 <b>466,00</b>
	76,03 <b>92,00</b>	82,64 <b>100,00</b>	89,26 <b>108,00</b>	79,34 <b>96,00</b>	94,21 <b>114,00</b>
	28,93 <b>35,00</b>	28,93 <b>35,00</b>	29,75 <b>36,00</b>	28,93 <b>35,00</b>	32,23 <b>39,00</b>
	352,07 <b>426,00</b>	357,85 <b>433,00</b>	383,47 <b>464,00</b>	367,77 <b>445,00</b>	400,00 <b>484,00</b>

	150100	150120	150150	200060	200100
	366,94 <b>444,00</b>	394,21 <b>477,00</b>	432,23 <b>523,00</b>	387,60 <b>469,00</b>	452,89 <b>548,00</b>
	366,94 <b>444,00</b>	394,21 <b>477,00</b>	432,23 <b>523,00</b>	387,60 <b>469,00</b>	452,89 <b>548,00</b>
	91,74 <b>111,00</b>	98,35 <b>119,00</b>	108,26 <b>131,00</b>	96,69 <b>117,00</b>	113,22 <b>137,00</b>

Cenas bez PVN, Euro												
Cenas ar PVN, Euro												
Izmērs (cm)*	060060 60x60	060090 60x90	080080 80x80	090090 90x90	090120 90x120	100100 100x100	100150 100x150	120120 120x120	150150 150x150			

### VIRSGAISMAS LOGS AR KUPOLA VIRSMU

				Iebūvēšanas slīpums (minimālais)		Iebūvēšanas slīpums (maksimālais)							
Virsmas													
ISD 0000	Caurspīdīgs akrila kupols	0	15	188,43 <b>228,00</b>	207,44 <b>251,00</b>	223,97 <b>271,00</b>	249,59 <b>302,00</b>	287,60 <b>348,00</b>	276,86 <b>335,00</b>	365,29 <b>442,00</b>	360,33 <b>436,00</b>	498,35 <b>603,00</b>	
ISD 0010	Caurspīdīgs polikarbonāta kupols	0	15	203,31 <b>246,00</b>	223,97 <b>271,00</b>	242,15 <b>293,00</b>	269,42 <b>326,00</b>	310,74 <b>376,00</b>	299,17 <b>362,00</b>	395,04 <b>478,00</b>	388,43 <b>470,00</b>	538,02 <b>651,00</b>	
ISD 0100	Pienbalts akrila kupols	0	15	188,43 <b>228,00</b>	207,44 <b>251,00</b>	223,97 <b>271,00</b>	249,59 <b>302,00</b>	287,60 <b>348,00</b>	276,86 <b>335,00</b>	365,29 <b>442,00</b>	360,33 <b>436,00</b>	498,35 <b>603,00</b>	
ISD 0110	Pienbalts polikarbonāta kupols	0	15	203,31 <b>246,00</b>	223,97 <b>271,00</b>	242,15 <b>293,00</b>	269,42 <b>326,00</b>	310,74 <b>376,00</b>	299,17 <b>362,00</b>	395,04 <b>478,00</b>	388,43 <b>470,00</b>	538,02 <b>651,00</b>	

### Ūv vērtība W/(m²K)\*\*

Pamatne													
CFP 0073QV	Neverama pamatne, izturīga pret ielaušanos, vienkameras stikla pakete	0.80		349,59 <b>423,00</b>	385,95 <b>467,00</b>	416,53 <b>504,00</b>	462,81 <b>560,00</b>	534,71 <b>647,00</b>	514,05 <b>622,00</b>	642,98 <b>778,00</b>	627,27 <b>759,00</b>	842,98 <b>1 020,00</b>	
CFP 0073	Neverama pamatne, vienkameras stikla pakete	0.87		283,47 <b>343,00</b>	312,40 <b>378,00</b>	337,19 <b>408,00</b>	374,38 <b>453,00</b>	433,06 <b>524,00</b>	416,53 <b>504,00</b>	520,66 <b>630,00</b>	508,26 <b>615,00</b>	682,64 <b>826,00</b>	
CVP 0073U	Manuāli darbināma pamatne, divkameru stikla pakete	0.87		478,51 <b>579,00</b>	514,88 <b>623,00</b>	545,45 <b>660,00</b>	591,74 <b>716,00</b>	663,64 <b>803,00</b>	642,98 <b>778,00</b>	771,90 <b>934,00</b>	756,20 <b>915,00</b>	-	
CVP 0573	Elektriski darbināma pamatne	0.87		698,35 <b>845,00</b>	734,71 <b>889,00</b>	765,29 <b>926,00</b>	811,57 <b>982,00</b>	883,47 <b>1 069,00</b>	862,81 <b>1 044,00</b>	991,74 <b>1 200,00</b>	976,03 <b>1 181,00</b>	1 191,74 <b>1 442,00</b>	
CVP 0673QV	Elektriski darbināma pamatne, izturīga pret ielaušanos	0.80		1 016,53 <b>1 230,00</b>	1 052,89 <b>1 274,00</b>	1 083,47 <b>1 311,00</b>	1 129,75 <b>1 367,00</b>	1 201,65 <b>1 454,00</b>	1 180,99 <b>1 429,00</b>	1 309,92 <b>1 585,00</b>	1 294,21 <b>1 566,00</b>	1 509,92 <b>1 827,00</b>	

### Iebūvēšanas piederumi

BBX 0000	Tvaika barjera virsgaismas logiem			21,49 <b>26,00</b>	23,14 <b>28,00</b>	23,14 <b>28,00</b>	23,97 <b>29,00</b>	24,79 <b>30,00</b>	24,79 <b>30,00</b>	28,93 <b>35,00</b>	28,10 <b>34,00</b>	29,75 <b>36,00</b>	
LSF 2000***	Ailes apdare virsgaismas logiem			268,60 <b>325,00</b>	287,60 <b>348,00</b>	294,21 <b>356,00</b>	307,44 <b>372,00</b>	326,45 <b>395,00</b>	319,83 <b>387,00</b>	352,07 <b>426,00</b>	345,45 <b>418,00</b>	383,47 <b>464,00</b>	
ZCE 0015	Paaugstinājums ar atloku, 16 cm			260,33 <b>315,00</b>	275,21 <b>333,00</b>	278,51 <b>337,00</b>	290,08 <b>351,00</b>	302,48 <b>366,00</b>	299,17 <b>362,00</b>	347,11 <b>420,00</b>	334,71 <b>405,00</b>	406,61 <b>492,00</b>	
ZCE 1015	Paaugstinājums, bez atloka, 16 cm			233,88 <b>283,00</b>	247,93 <b>300,00</b>	250,41 <b>303,00</b>	261,16 <b>316,00</b>	271,90 <b>329,00</b>	269,42 <b>326,00</b>	312,40 <b>378,00</b>	301,65 <b>365,00</b>	366,12 <b>443,00</b>	
ZZZ 210	Nostiprināšanas komplekts			57,02 <b>69,00</b>	60,33 <b>73,00</b>	61,16 <b>74,00</b>	63,64 <b>77,00</b>	66,12 <b>80,00</b>	66,12 <b>80,00</b>	76,03 <b>92,00</b>	73,55 <b>89,00</b>	89,26 <b>108,00</b>	

\* Visiem taisnstūra izmēriem (ar elektrisko un saules enerģiju) eņģes atrodas īsajā pusē.

\*\* Aprēķināts izmēram 120x120 cm ar 300 mm paaugstinājumu 0° jumta slīpumā.

\*\*\* Šis universālais risinājums ietver PVC paneļus un tvaika barjeru.

Cenas bez PVN, Euro											
Cenas ar PVN, Euro											
	060060	060090	080080	090090	090120	100100	100150	120120	150150		

### ŽALŪZIJAS VIRSGAISMAS LOGAM AR KUPOLA VIRSMU

FMG	Plisētās žalūzijas, elektriski vadāmas	240,50 <b>291,00</b>	245,45 <b>297,00</b>	250,41 <b>303,00</b>	256,20 <b>310,00</b>	266,12 <b>322,00</b>	261,16 <b>316,00</b>	276,86 <b>335,00</b>	271,90 <b>329,00</b>	-
FMK	Gaismu necaurīdīgās enerģoefektīvās žalūzijas, elektriski vadāmas	269,42 <b>326,00</b>	275,21 <b>333,00</b>	280,99 <b>340,00</b>	286,78 <b>347,00</b>	298,35 <b>361,00</b>	292,56 <b>354,00</b>	310,74 <b>376,00</b>	304,13 <b>368,00</b>	366,12 <b>443,00</b>
FSK	Gaismu necaurīdīgās enerģoefektīvās žalūzijas, solāri vadāmas	269,42 <b>326,00</b>	275,21 <b>333,00</b>	280,99 <b>340,00</b>	286,78 <b>347,00</b>	298,35 <b>361,00</b>	292,56 <b>354,00</b>	310,74 <b>376,00</b>	304,13 <b>368,00</b>	366,12 <b>443,00</b>
MSG	Saulessargs, solāri vadāms	265,29 <b>321,00</b>	271,07 <b>328,00</b>	276,86 <b>335,00</b>	282,64 <b>342,00</b>	294,21 <b>356,00</b>	288,43 <b>349,00</b>	305,79 <b>370,00</b>	300,00 <b>363,00</b>	-

Uzstādot elektriski darbināmās žalūzijas uz CFP neveramā virsgaismas loga, nepieciešams iegādāties arī KUX 110 vadības bloku.

Žalūziju krāsu kodi: FMG: 1016 – balta, 1259 – smilšu krāsa, FMK/FSK: 1045 – balta, 1047 – melna.

MSG un FSK nevar uzstādīt ar necaurredzamo kupolu.

FMK/FMG/FSK var kombinēt ar solāro saulessargu MSG.



Cenas bez PVN, Euro													
Cenas ar PVN, Euro													
Izmērs (cm)*	060060 60x60	080080 80x80	090060 90x60	090090 90x90	100100 100x100	120090 120x90	120120 120x120	150100 150x100	150150 150x150	200100 200x100			

### KUPOLS

Iebūvēšanas slīpums (minimālais) Iebūvēšanas slīpums (maksimālais)

Virsmas													
ISJ 0102	Divu slāņu akrila kupols, necaurredzams	0	15	157,02 <b>190,00</b>	187,60 <b>227,00</b>	173,55 <b>210,00</b>	208,26 <b>252,00</b>	231,40 <b>280,00</b>	240,50 <b>291,00</b>	300,83 <b>364,00</b>	305,79 <b>370,00</b>	416,53 <b>504,00</b>	437,19 <b>529,00</b>
ISJ 0103	Trīs slāņu akrila kupols, necaurredzams	0	15	212,40 <b>257,00</b>	252,89 <b>306,00</b>	234,71 <b>284,00</b>	280,99 <b>340,00</b>	312,40 <b>378,00</b>	324,79 <b>393,00</b>	405,79 <b>491,00</b>	412,40 <b>499,00</b>	561,98 <b>680,00</b>	590,08 <b>714,00</b>
ISJ 0112	Divu slāņu polikarbonāta kupols, necaurredzams	0	15	180,99 <b>219,00</b>	215,70 <b>261,00</b>	200,00 <b>242,00</b>	239,67 <b>290,00</b>	266,12 <b>322,00</b>	276,86 <b>335,00</b>	346,28 <b>419,00</b>	351,24 <b>425,00</b>	479,34 <b>580,00</b>	503,31 <b>609,00</b>
ISJ 0113	Trīs slāņu polikarbonāta kupols, necaurredzams	0	15	243,80 <b>295,00</b>	290,91 <b>352,00</b>	269,42 <b>326,00</b>	323,14 <b>391,00</b>	358,68 <b>434,00</b>	372,73 <b>451,00</b>	466,12 <b>564,00</b>	473,55 <b>573,00</b>	645,45 <b>781,00</b>	677,69 <b>820,00</b>

Uw vērtība ar divu slāņu virsmu W/(m²K)\*\* Uw vērtība ar trīs slāņu virsmu W/(m²K)\*\*

Pamatne													
CFJ 0010	Neverama pamatne, 15 cm	2.2	1.7	233,88 <b>283,00</b>	278,51 <b>337,00</b>	257,85 <b>312,00</b>	309,09 <b>374,00</b>	343,80 <b>416,00</b>	357,85 <b>433,00</b>	419,83 <b>508,00</b>	429,75 <b>520,00</b>	563,64 <b>682,00</b>	591,74 <b>716,00</b>
CFJ 1010	Neverama pamatne, 30 cm	2.2	1.7	292,56 <b>354,00</b>	347,93 <b>421,00</b>	322,31 <b>390,00</b>	386,78 <b>468,00</b>	429,75 <b>520,00</b>	447,11 <b>541,00</b>	523,97 <b>634,00</b>	537,19 <b>650,00</b>	704,96 <b>853,00</b>	-
CFJ 2020	Neverama pamatne, 50 cm	2.1	1.7	538,02 <b>651,00</b>	640,50 <b>775,00</b>	593,39 <b>718,00</b>	711,57 <b>861,00</b>	790,91 <b>957,00</b>	822,31 <b>995,00</b>	964,46 <b>1 167,00</b>	988,43 <b>1 196,00</b>	1 296,69 <b>1 569,00</b>	-
CVJ 0210	Elektriski vadāma pamatne, 15 cm	2.0	1.6	835,54 <b>1 011,00</b>	880,17 <b>1 065,00</b>	859,50 <b>1 040,00</b>	910,74 <b>1 102,00</b>	945,45 <b>1 144,00</b>	959,50 <b>1 161,00</b>	1 021,49 <b>1 236,00</b>	1 031,40 <b>1 248,00</b>	1 165,29 <b>1 410,00</b>	1 193,39 <b>1 444,00</b>
CVJ 1210	Elektriski vadāma pamatne, 30 cm	2.0	1.6	932,23 <b>1 128,00</b>	976,86 <b>1 182,00</b>	956,20 <b>1 157,00</b>	1 007,44 <b>1 219,00</b>	1 042,15 <b>1 261,00</b>	1 056,20 <b>1 278,00</b>	1 118,18 <b>1 353,00</b>	1 128,10 <b>1 365,00</b>	1 261,98 <b>1 527,00</b>	-
CVJ 2220	Elektriski vadāma pamatne, 50 cm	2.0	1.6	1 310,74 <b>1 586,00</b>	1 355,37 <b>1 640,00</b>	1 334,71 <b>1 615,00</b>	1 385,95 <b>1 677,00</b>	1 420,66 <b>1 719,00</b>	1 434,71 <b>1 736,00</b>	1 496,69 <b>1 811,00</b>	1 506,61 <b>1 823,00</b>	1 640,50 <b>1 985,00</b>	-

### Iebūvēšanas piederumi

ZCJ 0000	Nomaiņas rāmis kupolam	154,55 <b>187,00</b>	169,42 <b>205,00</b>	161,98 <b>196,00</b>	178,51 <b>216,00</b>	185,95 <b>225,00</b>	193,39 <b>234,00</b>	221,49 <b>268,00</b>	239,67 <b>290,00</b>	-	-
ZCJ 1112	Nomaiņas komplekts manuālai vēršanai	386,78 <b>468,00</b>	386,78 <b>468,00</b>	386,78 <b>468,00</b>	386,78 <b>468,00</b>	386,78 <b>468,00</b>	386,78 <b>468,00</b>	386,78 <b>468,00</b>	386,78 <b>468,00</b>	-	-
ZCJ 1210	Nomaiņas komplekts elektriskai vēršanai	601,65 <b>728,00</b>	601,65 <b>728,00</b>	-	601,65 <b>728,00</b>	601,65 <b>728,00</b>	-	601,65 <b>728,00</b>	-	-	-
ZZZ 210J	Nostiprināšanas komplekts	59,50 <b>72,00</b>	63,64 <b>77,00</b>	62,81 <b>76,00</b>	66,94 <b>81,00</b>	68,60 <b>83,00</b>	69,42 <b>84,00</b>	76,86 <b>93,00</b>	79,34 <b>96,00</b>	93,39 <b>113,00</b>	-
ZZZ 257	Aizsardzības režģis	76,86 <b>93,00</b>	109,92 <b>133,00</b>	99,17 <b>120,00</b>	129,75 <b>157,00</b>	150,41 <b>182,00</b>	156,20 <b>189,00</b>	194,21 <b>235,00</b>	203,31 <b>246,00</b>	273,55 <b>331,00</b>	-

\* Visiem tainstūra izmēriem (ar elektrisko un saules enerģiju) loga eņģes atrodas garākajā pusē.

\*\* Aprēķināts izmēram 120x120 cm ar 300 mm paaugstinājumu 0° jumta slīpumā.



Cenas bez PVN, Euro  
Cenas ar PVN, Euro

MK04 78x98	MK06 78x118	MK08 78x140	PK06 94x118	PK08 94x140	SK06 114x118	SK08 114x140	UK04 134x98

## DŪMU LŪKAS

		W/(m <sup>2</sup> K) Iebūvēšanas slīpums										
<b>GGL 307040D</b>	Priedes koks, apstrādāts ar trīskāršu pārklājumu, caurspīdīgs lakojuums, vienkameras stikla pakete	1.3	15-60	741,32 <b>897,00</b>	774,38 <b>937,00</b>	803,31 <b>972,00</b>	843,80 <b>1021,00</b>	876,86 <b>1061,00</b>	868,60 <b>1051,00</b>	925,62 <b>1120,00</b>	880,17 <b>1065,00</b>	
<b>GGL 306640D</b>	Priedes koks, apstrādāts ar trīskāršu pārklājumu, caurspīdīgs lakojuums, divkammeru stikla pakete	1.0	15-60	891,74 <b>1079,00</b>	938,02 <b>1135,00</b>	977,69 <b>1183,00</b>	1034,71 <b>1252,00</b>	1080,99 <b>1308,00</b>	1069,42 <b>1294,00</b>	1148,76 <b>1390,00</b>	1085,95 <b>1314,00</b>	
<b>GGU 007040D</b>	Balts poliuretāns ap koka kodolu ar papildu izturīgu pārklājumu, vienkameras stikla pakete	1.3	15-60	835,54 <b>1011,00</b>	876,86 <b>1061,00</b>	912,40 <b>1104,00</b>	962,81 <b>1165,00</b>	1004,13 <b>1215,00</b>	994,21 <b>1203,00</b>	1065,29 <b>1289,00</b>	1009,09 <b>1221,00</b>	
<b>GGU 006640D</b>	Balts poliuretāns ap koka kodolu ar papildu izturīgu pārklājumu, divkammeru stikla pakete	1.0	15-60	1023,14 <b>1238,00</b>	1080,99 <b>1308,00</b>	1130,58 <b>1368,00</b>	1201,65 <b>1454,00</b>	1259,50 <b>1524,00</b>	1244,63 <b>1506,00</b>	1344,63 <b>1627,00</b>	1266,12 <b>1532,00</b>	

Pieslēgums jāiegādājas atsevišķi.

ģeometriskais laukums Av, m <sup>2</sup> (laukums ir vienāds lūkām ar un bez deflektoriem)	0,63	0,77	0,92	0,95	1,14	1,17	1,40	1,13
Aktīvais laukums Aa, m <sup>2</sup> , dūmu lūkai ar deflektoru	0,36	0,46	0,59	0,53	0,68	0,61	0,77	0,54
Aktīvais laukums Aa, m <sup>2</sup> , dūmu lūkai bez deflektora	0,19	0,29	0,43	0,30	0,46	0,28	0,44	0,16

Cenas bez PVN, Euro  
Cenas ar PVN, Euro

Izmērs (cm)*	090120 90x120	100100 100x100	120120 120x120

Cenas bez PVN, Euro  
Cenas ar PVN, Euro

## ĪPAŠU FUNKCIJU JUMTA LOGI PLAKANIEM JUMTIEM

		Iebūvēšanas slīpums (minimālais)		Iebūvēšanas slīpums (maksimālais)				
<b>Virsmā</b>								
<b>ISD 0000</b>	Caurspīdīgs akrila kupols	0	15	287,60 <b>348,00</b>	276,86 <b>335,00</b>	360,33 <b>436,00</b>		
<b>ISD 0010</b>	Caurspīdīgs polikarbonāta kupols	0	15	310,74 <b>376,00</b>	299,17 <b>362,00</b>	388,43 <b>470,00</b>		
<b>ISD 0100</b>	Necaurredzams akrila kupols	0	15	287,60 <b>348,00</b>	276,86 <b>335,00</b>	360,33 <b>436,00</b>		
<b>ISD 0110</b>	Necaurredzams polikarbonāta kupols	0	15	310,74 <b>376,00</b>	299,17 <b>362,00</b>	388,43 <b>470,00</b>		
<b>Ūv vērtība W/(m<sup>2</sup>K)**</b>								
<b>Pamatne</b>								
<b>CXP 0473Q</b>	Manuāli darbināma pamatne jumta lūkai	0,86		1 069,42 <b>1 294,00</b>	1 028,10 <b>1 244,00</b>	1 254,55 <b>1 518,00</b>		
<b>CSP 1073Q</b>	Dūmu lūka	0,99		-	1 876,03 <b>2 270,00</b>	2 289,26 <b>2 770,00</b>		
<b>Iebūvēšanas piederumi</b>								
<b>BBX 0000</b>	Tvaika barjera virsgaismas logiem			24,79 <b>30,00</b>	24,79 <b>30,00</b>	28,10 <b>34,00</b>		
<b>LSF 2000***</b>	Ailes apdare virsgaismas logiem			326,45 <b>395,00</b>	319,83 <b>387,00</b>	345,45 <b>418,00</b>		
<b>ZCE 0015****</b>	Paaugstinājums ar atloku, 15 cm			302,48 <b>366,00</b>	299,17 <b>362,00</b>	334,71 <b>405,00</b>		
<b>ZCE 1015****</b>	Paaugstinājums, bez atloka, 15 cm			271,90 <b>329,00</b>	269,42 <b>326,00</b>	301,65 <b>365,00</b>		
<b>ZZZ 210</b>	Nostiprināšanas komplekts			66,12 <b>80,00</b>	66,12 <b>80,00</b>	73,55 <b>89,00</b>		

## PIEDERUMI DŪMU LŪKĀM

<b>KFA 100 WW</b>	VELUX dūmu detektors KFA 100		157,02 <b>190,00</b>
<b>KFC 210 EU</b>	VELUX vadības ierīce KFC 210		828,10 <b>1 002,00</b>
<b>KFC 220 EU</b>	VELUX vadības ierīce KFC 220		1 071,07 <b>1 296,00</b>
<b>KFK 100 WW</b>	VELUX vadības slēdzis KFK 100		157,02 <b>190,00</b>
<b>KFK 200 WW</b>	VELUX ventilācijas slēdzis KFK 200		157,02 <b>190,00</b>
<b>KFX 210 EU</b>	VELUX vadības sistēma KFX 210		972,73 <b>1 177,00</b>
<b>KLA 200 WW</b>	VELUX lietus sensors KLA 200		77,69 <b>94,00</b>

\* Visiem taisnstūra izmēriem (ar elektrisko un saules enerģiju) loga enģes atrodas īsākajā pusē.

\*\* Aprēķināts izmēram 120x120 cm ar 300 mm paaugstinājumu 0° jumta slīpumā.

\*\*\* Šis universālais risinājums ietver PVC paneļus, tvaika barjeru un pieslēgumus.

\*\*\*\* Nav savienojams ar CSP.

CXP nevar uzstādīt žalūzijas.

CSP nav saderīgs ar FMG un FMK. MSG un FSK var uzstādīt uz CSP.

UK08  
134x140

990,91  
**1 199,00**

1 240,50  
**1 501,00**

1 147,11  
**1 388,00**

1 459,50  
**1 766,00**

1,67

0,83

0,38

### Klasifikācija atbilstoši Eiropas standartam par dūmu un karstu- ma izplūdes ventilatoriem EN 12101-3

Īpašības	Vērtība	
Darbības uzticamība (Re)	Re 1 000 + 10 000	
Atvēršanās zem slodzes (SL)	<b>Slīpam jumtam:</b> Visiem izmēriem = SL1000	<b>Plakanam jumtam:</b> Izmēram 100x100 = SL1000 Izmēram 120x120 = SL500
Zema apkārtējā temperatūra	T (-15)	
Stabilitāte zem vēja slodzes (WL)	WL 3000	
Izturība pret karstumu (B)	B 300	
Reakcija pret uguni (V)	Reakcija pret uguni GGL 40D: C-s1, d2 Reakcija pret uguni GGÜ 40D: D-s2, d2 Reakcija pret uguni CSP: B-S1, d0	

Lai iegūtu vairāk informācijas, apmeklējiet vietni velux.lv. Mēs paturam tiesības veikt izmaiņas specifikācijās.

#### Elektroinstalācijas shēma slīpam jumtam

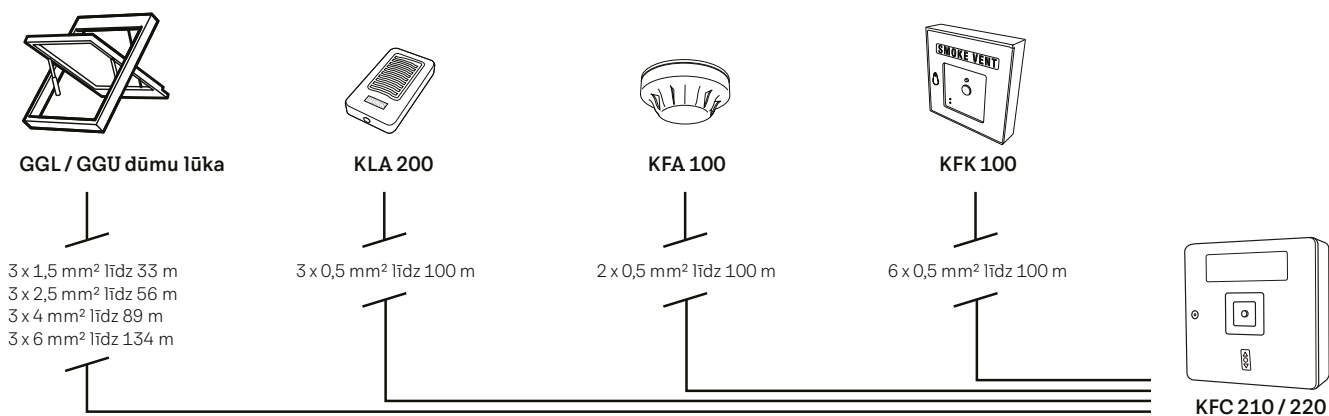

#### Elektroinstalācijas shēma plakanam jumtam

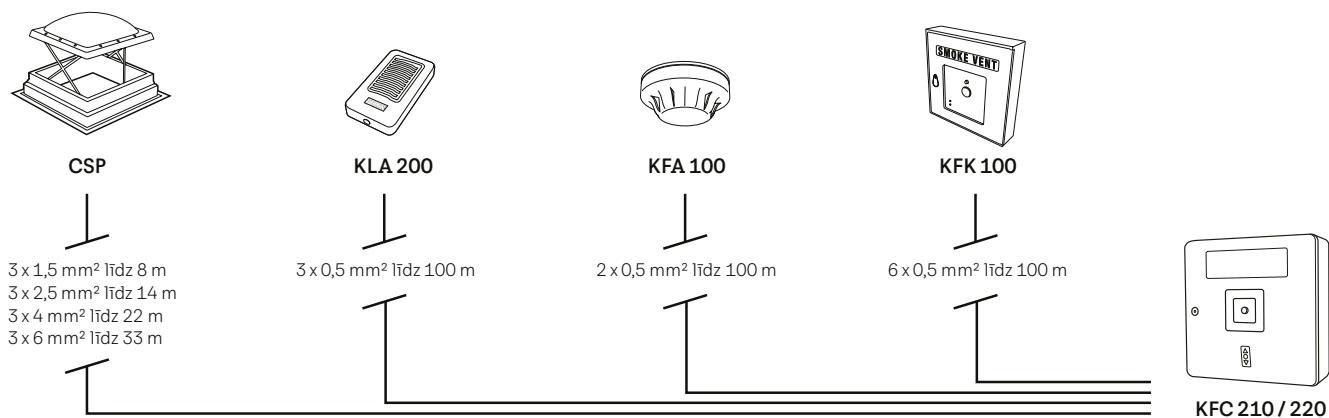

Mēs pārveidojam telpas kopš 1941. gada. Vairāk nekā 80 gadus, VELUX ir palīdzējis cilvēkiem iedomāties un pārveidot telpas, izmantojot dienasgaismu un svaigu gaisu caur jumtu. Mūsu produktu klāstā ietilpst jumta logi, dekoratīvās žalūzijas, saulesargi un slēdži, kā arī iebūvēšanas piederumi un viedās mājas risinājumi. Radot gaišāku, veselīgāku, ilgtspējīgāku vietu, kur dzīvot, strādāt, mācīties un spēlēties, mēs piedāvājam uzlabot ikviena ikdienas dzīvi visā pasaulē. Mēs strādājam globāli gan pārdošanā, gan ražošanā. Mēs trādājam vairāk nekā 40 valstīs, un mums ir ap 11 500 darbinieku visā pasaulē. VELUX grupa pieder sabiedrībai ar ierobežotu atbildību VKR Holding A/S, kas pilnībā pieder bezpeļņas labdarības fondiem (VELUX FOUNDATIONS) un ģimenei. Lai iegūtu papildinformāciju, apmeklējiet vietni [velux.com](http://velux.com).

VELUX Latvia SIA  
Liepājas iela 34  
LV-1002, Rīga

Tel: 80 00 88 02

E-pasts: [velux.latvia@velux.com](mailto:velux.latvia@velux.com)  
Mājaslapa: [www.velux.lv](http://www.velux.lv)

[www.facebook.com/VELUXLatvia](https://www.facebook.com/VELUXLatvia)  
[www.youtube.com/@VELUXLatvia](https://www.youtube.com/@VELUXLatvia)

