

Planning aids

Industrial installations

Cable support systems and connection and fastening systems for industry and construction project infrastructure



Towards the future

Because, for us, product features such as installation speed, load capacity, functionality and availability are at the forefront of every innovation, OBO systems are always reliable, safe and of the highest quality. A high production depth and strong process automation also allow us to deal with the requirements of our customers in a targeted manner.

For the new edition of our catalogue, we have once again questioned our own processes. Is OBO a progressive, flexible company? Are our structures effective and our processes efficient? Do we know our markets to a sufficient level? And primarily: Are we actually the best possible partner that you could imagine?

For us to be able to answer these questions with a confident “Yes”, we have optimised our structures once again, sharpened our profile and defined our services more clearly. This will allow us to react more quickly and reliably in future – both nationally and internationally – and also address the requirements of each individual customer even better.

This optimisation is best reflected in the three new installation areas. Thanks to this considerably more streamlined structure, we can emphasise the product benefits even further and make the appropriate areas of application more tangible.

Because it is better:
OBO – simply better

OBO Product Worlds



Industrial installations

Cable support systems and connection and fastening systems for industry and construction project infrastructure

- Cable trays
- Mesh cable trays
- Cable ladders
- Industrial ducts and trunking
- Support structures
- Electrical installation pipes
- Wiring ducts and trunking
- Power supply units
- Distributors
- Junction boxes
- Concealed and cavity wall installations
- Terminals
- Cable glands
- Installation and fastening clips
- Anchors and fastening systems



Building installations

Cable routing and underfloor systems for administrative and functional buildings including architectural solutions

- Electrical installation ducts and trunking
- Device installation ducts and trunking
- Skirting ducts and trunking
- Service poles
- Underfloor applications in screed
- Underfloor applications in concrete
- Underfloor applications, on-floor
- Service outlets for underfloor applications
- Floor sockets and floor boxes
- Installation housings and supports
- Tabletop sockets
- Sockets, switches, data and multimedia technology



Safety and protection installations

Lightning, surge and fire protection systems









- Surge protection
- Explosion protection
- Lightning protection
- Earthing
- Equipotential bonding
- Insulation
- Cable bandages – prevention of the spread of fire
- Escape route installations – false ceiling mounting
- Fire protection ducts – protection of escape routes
- Fire protection ducts
- Systems for the maintenance of electrical functionality – cable-specific routing variants
- Systems for the maintenance of electrical functionality – standard support structures and routing systems
- Systems for the maintenance of electrical functionality – FireBox T series junction boxes
- Anchoring

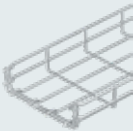

Planning aids

Industrial installations

Cable support, connection and fastening systems for industry and construction project infrastructure

	General planning aids	7
	Cable trays	59
	Mesh cable trays	85
	Cable ladders	97
	Industrial ducts and trunking	115
	Support structures	133
	Power supply units	161
	Wiring ducts and trunking	175
	Anchors and fastening systems	183



High demands are placed on products that are used in industrial environments. Electrical installations used in industrial settings are exposed to different weather and ambient conditions, need to withstand mechanical demands and loads and must also provide protection in the event of fire.

That is why the properties of the materials used are critical to the selection of installation systems for industrial applications. Depending on where they are used, the corrosion resistance and load-bearing capacity of metals or the chemical and impact resistance of plastics are just some of the key selection criteria. In addition to the structural requirements, other points that can be decisive for the type and design of electrical installation systems in industrial settings include the maintenance of electrical functionality in the event of fire, electromagnetic compatibility or explosion protection.

This catalogue is intended to be both a source of information and a decision-making aid. It provides information on materials, corrosion resistance, surface refinements, testing procedures and protection ratings, among other things. It also explains how cable volumes and loads are calculated and how these can be used to select the appropriate installation system. Maintaining the electrical function of safety-relevant systems in the event of fire is also addressed, as are electromagnetic compatibility and important certificates and test marks.

General planning aids

Surfaces and corrosion	8
Properties of plastics	18
Protection ratings	22
Nominal values of electrical equipment	24
Zone division for explosive areas	25
Cable sizes	26
Basic values for calculation of the cable volume	27
Fastening clips	28
Selection of the correct cable support system	29
Cable load	32
Cable glands and DIN EN 50262	40
Information on cable fastening	41
Classification of installation pipes (according to DIN EN 61386-1)	42
Definition of electromagnetic compatibility (EMC)	44
Guaranteeing EMC	45
Magnetic shield insulation of cable support systems	46
Transfer impedance of cable support systems	47
Maintenance of the electrical supply	48
Standards, certifications and test marks	52
Every test mark at a glance	54
First-hand support and knowledge	55
OBO Construct – planning software and product configurators	56



Metal: Corrosion and corrosion protection



Corrosion

(from the Latin *corrodere*, “to decompose, erode, gnaw away”) in a technical context is a reaction between a material (generally a metal) and its surroundings leading to a measurable change in the material and potentially impairing the functionality of a component or system.

A large number of products used in industrial installations are made of metal. Metals are much tougher than many other materials and are less sensitive to mechanical loading. The OBO metal products are made of aluminium, die-cast zinc, stainless steel or steel.

Steel (St), the most commonly used material, is very strong and has good elasticity and chemical resistance. However, steel is susceptible to corrosion and must therefore be protected accordingly.

Stainless steels consist mainly of alloyed, very hard and rustproof steels. Stainless steels are divided into quality classes according to the percentage of alloys. These are indicated by the material number according to DIN EN 10027.

Aluminium (Al), as a light metal, has comparatively low strength but good electrical conductivity and high corrosion resistance.

Die-cast zinc components (Zn) are very strong and hard. The manufacturing process enables the production of very precise components with good corrosion resistance.

Corrosion protection

“Corrosion protection” means all steps taken to prevent corrosion damage to metallic components. It is impossible to prevent corrosion permanently, so corrosion protection measures generally aim to reduce the speed of corrosion so that the component is not damaged by corrosion for the duration of its service life. The term “passive corrosion protection” refers to all measures designed to shield products from corrosive media. Coatings are one way of achieving passive corrosion protection. At OBO, most steel products are protected from corrosion by a layer of zinc. Zinc coatings can be applied to components using a variety of methods.

Zinc slat covering

Zinc slat coverings are coatings applied in a non-electrolytic manner. They offer a cathodic protection and thus have excellent corrosion protection, while at the same time, there is no risk of hydrogen-induced breakage. Due to these properties, this coating type is used for connection components with a high strength classification or structural parts with high tensile strength. The low layer thickness of the zinc slat covering allows a thin, homogeneous coating, which is particularly important for maintaining the accuracy of screw threads. This coating achieves a resistance of 480 hrs in the salt spray test for the connection elements.

Galvanisation types

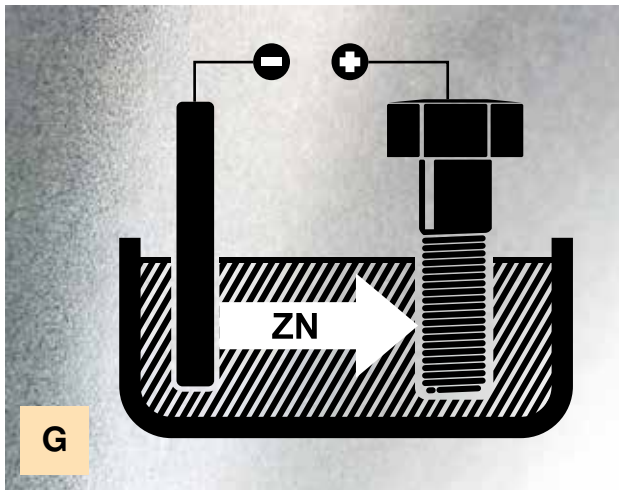

Electrogalvanisation – electrolytic galvanisation in accordance with DIN EN 12329

In electrogalvanisation, the component is coated by dipping it not in molten zinc, but in a zinc electrolyte, through which a direct electric current is passed.

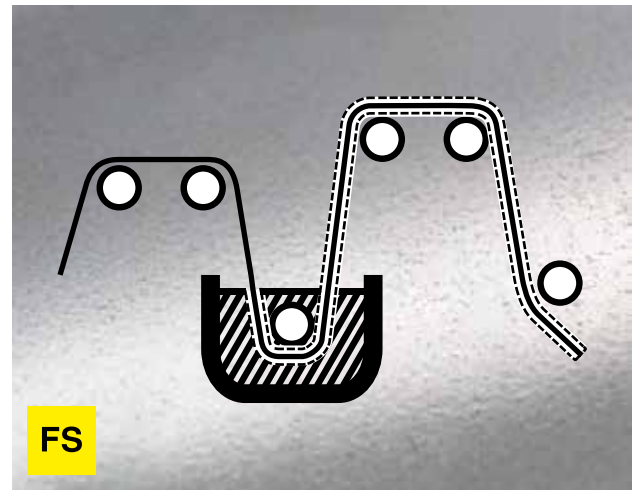

Strip galvanising – hot galvanised according to the strip-galvanising method in accordance with DIN EN 10327 (formerly DIN EN 10147 and DIN EN 10142)

Strip galvanisation or Sendzimir galvanisation is where a continuous ribbon of steel is galvanised in a continuous line.

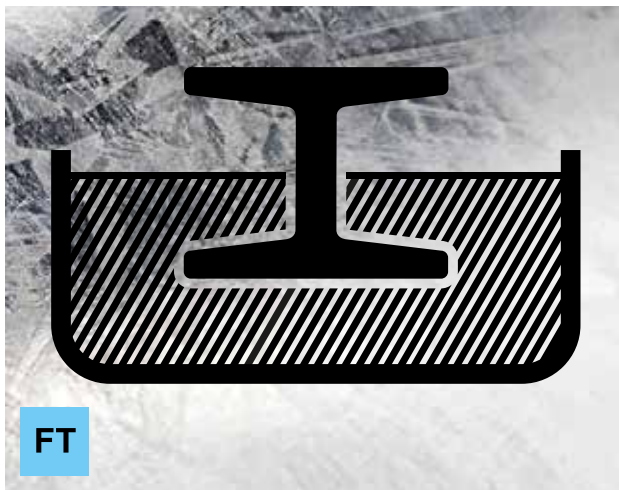

Hot-dip galvanisation – hot galvanisation using the dipping method according to DIN EN ISO 1461

Batch galvanisation is mainly used for galvanising pre-fabricated steel parts, by dipping them in molten zinc at a temperature of around 450 °C.



Hot-dip coating – zinc-aluminium coating in accordance with DIN EN 10346

In contrast to conventional coating systems, the material being galvanised in the double-dip process passes through two baths in succession: the first contains pure zinc, the second a zinc-aluminium alloy.

Surface testing and corrosion categories

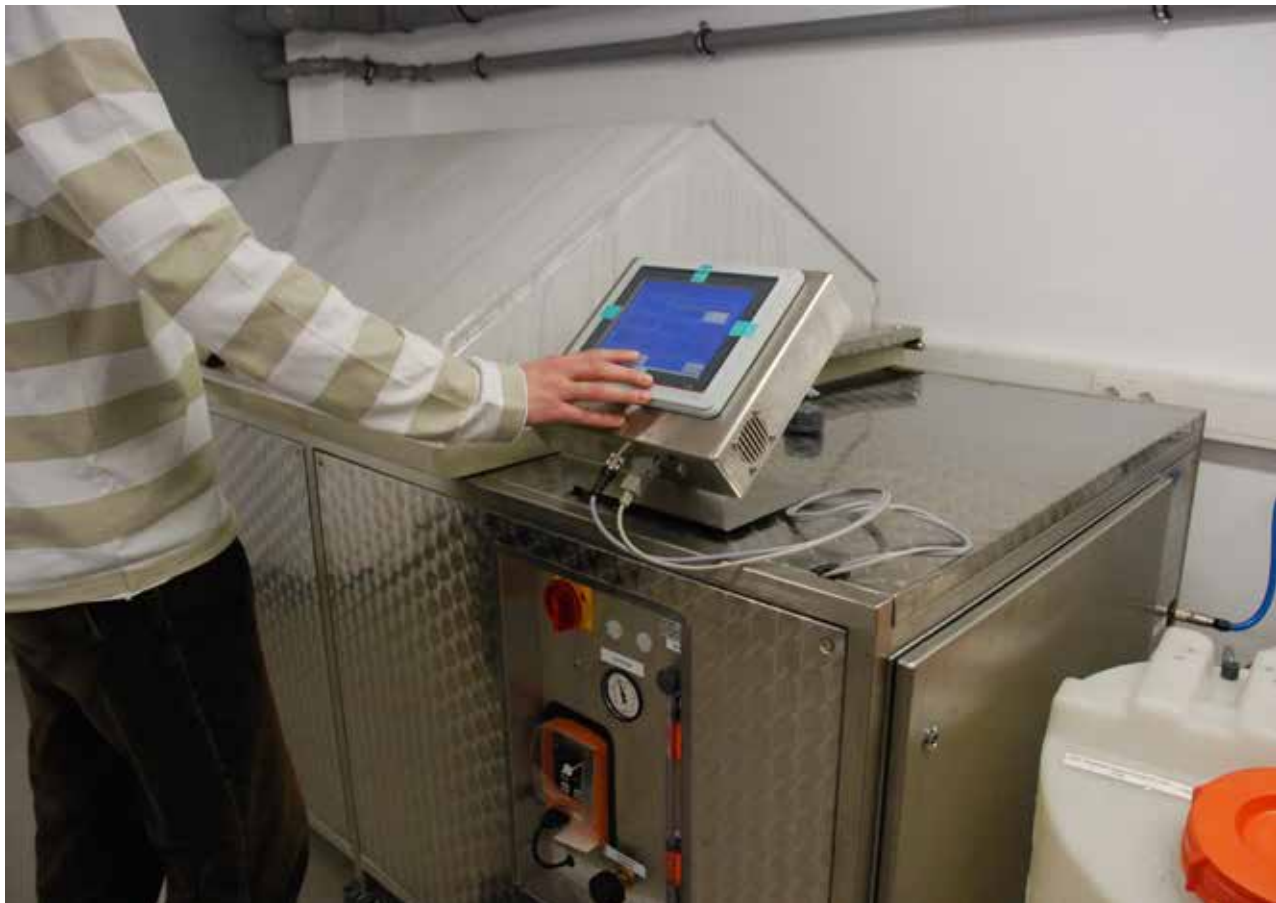

Classification of corrosion resistance

All the system components must show sufficient resistance against corrosion in agreement with the standard DIN EN 61537. The minimum zinc layer thicknesses are determined through a measurement. The grouping into the appropriate class is detailed in the table "Classification of corrosion resistance". The table "Corrosion categories according to DIN EN ISO 12944" shows the area of application and the zinc loss to be expected.

Classification of corrosion resistance

All components, depending on the environment, must show sufficient resistance against corrosion in agreement with the standard DIN EN 61537.

This is how corrosion categories are determined, e.g. with a salt spray test. In this procedure, components are sprayed with salt for a certain time period. The resulting level of red rust is the basis for allocation to a corrosion category, i.e. in which environment the component is resistant to corrosion.



Classification of corrosion resistance (from the draft of DIN EN 61537)

Class	Reference material and surface treatment
0*	None
1	Electroplated to a minimum thickness of 5 µm
2	Electroplated to a minimum thickness of 12 µm
3	Pre-galvanised to grade 275 to EN 10327 and EN 10326
4	Pre-galvanised to grade 350 to EN 10327 and EN 10326
5	Post-galvanised to a zinc mean coating thickness of (minimum) 45 µm according to ISO 1461
6	Post-galvanised to a zinc mean coating thickness (minimum) of 55 µm according to ISO 1461
7	Post-galvanised to a zinc mean coating thickness (minimum) of 70 µm according to ISO 1461
8	Post-galvanised to a zinc mean coating thickness (minimum) of 85 µm according to ISO 1461 (usually high silicon steel)
9A	Stainless steel manufactured to ASTM: A 240/A 240M – 95a designation S30400 or EN 10088 grade 1-4301 without a post-treatment *
9B	Stainless steel manufactured to ASTM: A 240/A 240M – 95a designation S31603 or EN 10088 grade 1-4404 without a post-treatment *
9C	Stainless steel manufactured to ASTM: A 240/A 240M – 95a designation S30400 or EN 10088 grade 1-4301 with a post-treatment **
9D	Stainless steel manufactured to ASTM: A 240/A 240M – 95a designation S31603 or EN 10088 grade 1-4404 with a post-treatment **

* For materials which do not have a declared corrosion resistance classification

** The end treatment process is used to improve the protection against crack corrosion and the contamination of other steels

Corrosivity categories to DIN EN ISO 12944

Corrosion category	Typical environment, inside	Typical environment, outside	Corrosion load	Average zinc removal
C 1	Heated buildings with neutral atmospheres, e.g. offices, shops, schools, hotels	-	Insignificant	<0.1 µm/a
C 2	Unheated buildings in which condensation can occur, e.g. warehouse, sports halls	Atmosphere with low level of impurities. Often rural areas	Low	0.1 to 0.7 µm/a
C 3	Production facilities with a high level of humidity and some air impurities, e.g. plants for food production, laundries, breweries, dairies	City and industrial atmosphere, considerable impurities through sulphur dioxide, coastal areas with low salt load	Medium	0.7 to 2.1 µm/a
C 4	Chemical plants, swimming pools, boat sheds over seawater	Industrial areas and coastal areas with low salt load	Strong	2.1 to 4.2 µm/a
C 5-I	Buildings or areas with almost constant condensation and with high levels of impurities	Industrial areas with high levels of humidity and aggressive atmosphere	Very strong (industry)	4.2 to 8.4 µm/a
C 5-M	Buildings or areas with almost continuous condensation and with high levels of impurities	Coastal or offshore areas with salt load	Very strong (sea)	> 4.2 to 8.4 µm/a

Contact corrosion



If two different metals are conductively connected with each other, contact corrosion can occur. This poses a considerable risk to the load capacity and lifespan of the components used.

The level of contact corrosion is primarily determined by the level of the potential difference between the contact partners. Contact corrosion occurs at potential differences of 100 mV or greater and the anodic (electrically negative) partner is at risk of corrosion. Therefore, strongly non-precious metals should never be brought into contact with precious metals.

Additional contact corrosion criteria:

- Level of electrical resistance between the contact partners. The higher the resistance, the lower the contact corrosion. Positive on Al and Ti.
- Occurrence of an electrolyte. An electrolyte, such as perspiration or condensation, attacks the protective layers, increasing conductivity. Dirt increases this effect through released ions.
- Length of the impact of the electrolyte. The longer the electrolyte is active, the greater the corrosion will be.
- The surface ratios of the contact partners influence the current density. The best thing to have is a small surface ratio of the "precious" to the "less precious" contact partner.
- Different environments or atmospheres can increase or influence the risk of contact corrosion to varying degrees.







Installation locations

Whether indoors or outdoors, in aggressive atmospheres or under special hygienic conditions, OBO can offer the perfect surface and materials for your installation, no matter what the requirements may be.

OBO metal products are machined from high-quality sheet steel or steel wire and are available with various surfaces.

Different hardening and coating methods ensure tailor-made corrosion protection, specially tailored to the appropriate application:

Application	Material	Surface protection
Indoors 	St Steel	L Painted/powder-coated
	St Steel	FS Strip galvanised (approx. 20 µm) DIN EN 10327
	St Steel	G Electrogalvanised/electrolytically galvanised (approx. 2.5–10 µm), DIN EN 12329
Outdoors 	St Steel	FT Hot galvanised (approx. 40–60 µm) DIN EN ISO 1461
	St Steel	DD Zinc-aluminium coating (approx. 23 µm) DIN EN 10346
	VA Stainless steel A2	
	VA Stainless steel A4	
Especially corrosive areas 	VA Stainless steel A2	
	VA Stainless steel A4	

Contact corrosion in different environments



Land climate



Component (large)	Component (small)					
	FT	VA	Alu	Cu	CuZn 37	Zn
Steel, galvanised St FS FT G DD	✓	✓	✓	!	○	✓
Stainless steel VA V2A V4A V5A	✓	✓	○	○	○	✓
Aluminium Alu	✓	✓	✓	!	○	✓
Copper Cu	○	○	○	✓	○	!
Brass CuZn 37	✓	!	○	○	✓	!
Die-cast zinc Zn	○	○	✓	✗	○	✓

- ✓ No risk of contact corrosion
- Low risk of contact corrosion
- ! Risk in case of small area ratio (area of non-precious metal/area of precious metal)
- ✗ High risk of contact corrosion



Industrial atmosphere



Component (large)	Component (small)					
	FT	VA	Alu	Cu	CuZn 37	Zn
Steel, galvanised St FS FT G DD	✓	✓	○	✗	!	✓
Stainless steel VA V2A V4A V5A	✓	✓	○	○	○	✓
Aluminium Alu	○	○	✓	!	!	✓
Copper Cu	!	!	✗	✓	○	!
Brass CuZn 37	○	○	✗	○	✓	○
Die-cast zinc Zn	✓	✓	✓	✗	!	✓

- ✓ No risk of contact corrosion
- Low risk of contact corrosion
- ! Risk in case of small area ratio (area of non-precious metal/area of precious metal)
- ✗ High risk of contact corrosion



Maritime climate



Component (large)	Component (small)					
	FT	VA	Alu	Cu	CuZn 37	Zn
Steel, galvanised St FS FT G DD	✓	○	✗	!	✗	○
Stainless steel VA V2A V4A V5A	○	✓	✗	○	○	✓
Aluminium Alu	✗	○	✓	!	!	✓
Copper Cu	!	!	✗	✓	○	!
Brass CuZn 37	○	○	✗	○	✓	○
Die-cast zinc Zn	✓	✓	✓	✗	!	✓

- ✓ No risk of contact corrosion
- Low risk of contact corrosion
- ! Risk in case of small area ratio (area of non-precious metal/area of precious metal)
- ✗ High risk of contact corrosion



Surfaces for special visual requirements or specific environmental conditions



Applications with specific optical requirements or special environmental conditions

Colour-coated products are becoming ever more popular. The coating may be required for optical reasons or for reasons of corrosion protection.

Colour coatings for reasons of corrosion protection

- Products in FT (hot-dip galvanised version)
- All RAL colours available
- Coating of the visible surfaces or the complete system
- Suitable for the colour of the structure when routed openly
- Separation of different voltages/functions (e.g. blue 230/400 V power supply; red weak current such as telephone cables and IT)

Colour-coated systems are not specifically indicated in this Industrial installation product catalogue. You can obtain details of these systems by contacting our telephone hotline on +49 (0)2371 7899-2000.

Plastic: Materials and properties

Essentially plastics be of one of three types: thermoplastics, elastomers and Duroplast.

Thermoplastics

Also known as plastomers, these are plastics that can be shaped within a specific temperature range. This process is reversible, in other words, thermoplastics can theoretically be cooled and then melted down again any number of times. Another unique advantage of thermoplastics is that they can be welded.

Elastomers

Elastomers have a fixed shape, but can be elastically deformed. They can elastically deform under tensile and compressive stresses, but afterwards will return to their original shape. Elastomers are used for producing seals and membrane entries.

Duroplastics

Duroplastics or thermosetting polymers/plastics, are plastics that can no longer be deformed following curing. Duroplasts produce hard, glass-like (brittle) polymeric materials with a high thermo-mechanical strength.

Properties

The area of application for which plastic OBO products are suitable depends mainly on the properties of the material being used. The most important material properties are:

- Temperature resistance
- Risk of stress cracks
- Chemical resistance
- Halogen freedom
- UV resistance
- Flame resistance

Temperature ranges of plastics

		Material	Max. temperature resistance permanent	Max. temperature resistance short-term	Min. temperature resistance static
Thermoplast	ABS/ASA	Acrylonitrile butadiene styrene	70 °C	85 °C	-40 °C
	EVA	Ethylene vinyl acetate	55 °C	70 °C	-50 °C
	PA	Polyamide	120 °C	150 °C	-40 °C
	PA/GF	Polyamide, fibre-glass reinforced	120 °C	160 °C	-20 °C
	PBPT	Polybutylene terephthalate	120 °C	140 °C	-40 °C
	PC	Polycarbonate	110 °C	125 °C	-35 °C
	PE	Polyethylene	70 °C	90 °C	-40 °C
	PP	Polypropylene (PP)	90 °C	110 °C	-30 °C
	PS	Polystyrene	70 °C	80 °C	-10 °C
	PVC	Polyvinyl chloride	65 °C	80 °C	-30 °C
Elastomer	NBR/SBR	Rubber mixture	100 °C	110 °C	-40 °C
	NBR	Nitrile rubber	100 °C	110 °C	-30 °C
Duroplast	UF	Duroplast, Amino-plast, type 131.5	65 °C	90 °C	-40 °C
	MF	Duroplast, melamine resin, type 150	80 °C	110 °C	-40 °C

Risk of stress cracks

Medium	ABS/ASA	UF	MF	EVA	NBR/SBR	NBR	PA	PA/GF	PBPT	PC	PE	PP	PS	PVC
Risk of stress cracks	✗	✓	✓	✓	✓	✓	✓	○	○	✓	!	✓	✗	○

Danger of tension cracks:

✓ Virtually negligible

○ Low

! High

✗ Very high

Chemical resistance

Medium	ABS/ASA	UF	MF	EVA	NBR/SBR	NBR	PA	PA/GF	PBPT	PC	PE	PP	PS	PVC
Petroleum	✓	✓	✓	○	✓	○	✓	✓	✓		○	○	○	✓
Fat	✓	✓	✓	✓	✓	○	✓	✓	✓				○	✓
Benzole	!	✓	✓	○	✓	!	✓	✓	○	!	!	○	!	!
Solvents	!						✓	✓	○				!	!
Formic acid	✓	!									!	○		
Citric acid	✓	!		○							!			
Lactic acid	✓	!		○							!	○	!	!
Hydrochloric acid	○	!									✓			!
Sulphanic acid	○	!									✓			!
Acetone	!	✓					✓	✓	○	!	!	○	!	!
Petrol	!	✓	✓	○	○	!	✓	✓	✓	✓	!	○	!	✓
Butyric acid	!	!		○							!	○		!
Chlorine	!						!	!	!	!	!	!	!	
Acetic acid	!	!		○							!		!	
Nitric acid	!	!									✓		!	
Ester		✓	✓	○	!	!								
Alcohol		✓	✓	○			✓						✓	
Mild alkalis		✓	✓	✓	✓	✓	○	○	!		✓	✓		✓
Mild acids		○	○	✓	✓	✓	!	!	✓	✓	✓			✓
Ether		✓	✓	○									!	
Water		✓	✓	✓	✓	✓								
Strong acids		!	!	○						!	!	!		!
Strong alkalis		!	!	✓					!		✓	✓		✓
Hydrofluoric acid				○							✓			
Paraffin hydrocarbon				○								○		
Haloalkanes				!										
Ketones				!	!								!	
Aldehyde				✓										
Organid acids				○							!	○		
Seawater					✓	✓								
Diesel fuel							✓	✓	✓		○	○	!	
Ammoniac									○				!	

Resistance:

✓ Resistant

○ Limited resistance

! Not resistant

Plastic: material properties



Halogen freedom

Estimates suggest that around 95% of fire victims die not due to the immediate effects of the fire, but of poisoning from the smoke. In addition, the corrosive fire gases created during fires cause immense damage to property and can permanently damage the structure of a building. Therefore, halogen-free installation systems should or must always be used in public areas (emergency routes, lifts, etc.). The chemical composition of these halogen-free systems is designed in such a way that, in the case of fire, they produce less hazardous

(toxic/corrosive) gases, which could combine with extinguishing agents to form hydrochloric acid. In the sense of the standard DIN VDE 0472, this means that materials are considered halogen-free when “the proportions of the halogens chlorine, bromine and iodine are $\leq 0.2\%$ for chlorine and $\leq 0.1\%$ for fluorine”.

OBO Bettermann offers a wide range of halogen-free products that reduce the risk of harm to people and property to a minimum in case of fire.



UV resistance

Outdoor installations should always be viewed particularly critically with regard to the mounting locations and the selection of the installation materials.

UV radiation is damaging to many plastics, causing them to turn yellow and/or brittle or lose their elasticity. However, plastics can be protected against UV damage through the addition of UV stabilisers. Products made from UV-resistant materials are specially marked. In general,

besides UV radiation, installations outdoors must also take other environmental influences into account. Factors such as maximum temperatures, regularity of (extreme) temperature changes, humidity and the location of use/mounting (housing, industry, town, region, continent) all have an important role to play here.



Flame-resistance/fire-resistance

Materials are described as flame-resistant if they prevent the spread of fire or are sufficiently fire-resistant. According to DIN EN 60695-2-11 (VDE 0471 Part 2-11), electrical connection materials must be subjected to a glow wire test, in order to evaluate the fire risk of the end product. When the glow wire test is being carried out, a

glowing wire (for temperature see table below) is inserted into the component to be tested for a period of 30 seconds and then removed. After 30 seconds at the latest, the object, if it has caught light, must have extinguished again, in order to specify the flame resistance.



Types of installation systems

Types of samples Test temperatures in °C	Surface-mounted	Concealed	Flush-mounted	Cavity wall/ furniture	Concrete structure	Installation duct
Connection sockets	650	650	750	850	650	750
Accessory sockets and device connection sockets	750	650	-	850	650	750
Ceiling lights, connection sockets	750	650	-	850	650	750
Wall light connection sockets	750	650	-	850	650	750
Device connection sockets	750	650	-	850	650	750
Connection sleeves	750	-	-	-	-	750
Insulation sections, which support active parts	960	-	-	-	-	-

Protection ratings



IP protection rating

The IP protection rating specifies how far a component is protected against contact and foreign bodies and the ingress of water. The IP protection ratings are controlled by the standard DIN EN 60529 (VDE 0470 Part 1). The IP is always made up of two digits.

The first digit designates the contact and foreign body protection. On the one hand, it specifies how far a housing prevents access to dangerous parts, by preventing or limiting the ingress of body parts or objects held by a person. On the other hand, it specifies how far the housing protects the installed resources against the ingress of solid foreign bodies.

Protection rating

First code digit	...against access to the dangerous parts	...against solid foreign bodies
0	Protected against access to dangerous parts with the back of the hand	Not protected
1	Protected against access to dangerous parts with a finger	Protected against solid foreign bodies of 50 mm diameter and larger
2	Protected against access to dangerous parts with a tool	Protected against solid foreign bodies of 12.5 mm diameter and larger
3	Protected against access to dangerous parts with a wire	Protected against solid foreign bodies of 2.5 mm diameter and larger
4	Protected against access to dangerous parts with a wire	Protected against solid foreign bodies of 1.0 mm diameter and larger
5	Protected against access to dangerous parts with a wire	Dust-protected
6	Protected against access to dangerous parts with a wire	Dust-proof



The second digit specifies the protection against water. It specifies how far the resource is protected against incoming water and the resulting damage.

Protection rating against the entry of water with a damaging impact

Second code digit	Short description	Definition
0	Not protected	-
1	Protected against water droplets	Droplets falling vertically may have no damaging impact.
2	Protected against water droplets when the housing is tilted to up to 15°	Droplets falling vertically may not have a damaging impact, if the housing is tilted to angle of 15° on either side of the vertical.
3	Protected against spray water	Water being sprayed at an angle of 60° on both sides of the vertical may not have any damaging impact.
4	Protected against spray water	Water spraying the housing from any direction may not have any damaging impact.
5	Protected against water jets	Jets of water pointing at the housing from any direction may not have any damaging impact.
6	Protected against strong water jets	Strong jets of water pointing at the housing from any direction may not have any damaging impact.
7	Protected against the effects of being temporarily immersed in water	If the housing is sometimes underwater under standard pressure and time conditions, then water may not enter in such volumes as would have a damaging impact.
8	Protected against the effects of being continuously immersed in water	If the housing is continuously underwater, then water may not enter in such volumes as would have a damaging impact and this shall be subject to conditions to be agreed between the manufacturer and the user. However, the conditions are more difficult to fulfil than for number 7.



IK code

The IK code to DIN EN 50102 indicates the protection rating of housings against external mechanical loads. It is made up of the code letters IK and a two-digit number from 00 to 10. Each group of numbers stands for a load energy value in Joules (J). The IK code always applies to

the complete housing, which guarantees the protection of resources against the damaging effects of mechanical loads. The housings are tested by knocking them with different testing hammers.

IK code	00	01	02	03	04	05	06	07	08	09	10
Stress energy value [J]	-	0.15	0.20	0.35	0.50	0.70	1	2	5	10	20

Nominal values of electrical equipment



When using junction boxes, connection sockets and connection terminals, the resources are assigned nominal values. In the designation, a distinction is made between the maximum approved voltage (nominal voltage), the

maximum approved current (nominal current) and the maximum approved cross-section (nominal cross-section of the cables to be connected).

2,5
mm²

Nominal cross-section

Largest tested-approved cross-section of the cables to be connected.

16
A

Nominal current

The nominal current is the highest permissible operating current that can be continuously passed through connections (e.g. terminals) marked with that value.

660
V

Nominal voltage

Greatest approved voltage at the connection point.

In addition to the nominal values, the number of entries for junction boxes and the number of poles of clamp connectors are also possible labels.

12

Number of poles

Number of connection points of the clamp connector.

7

Number of entries

Number of entries in an electrical connection box or connection socket.

Zone division for explosive areas

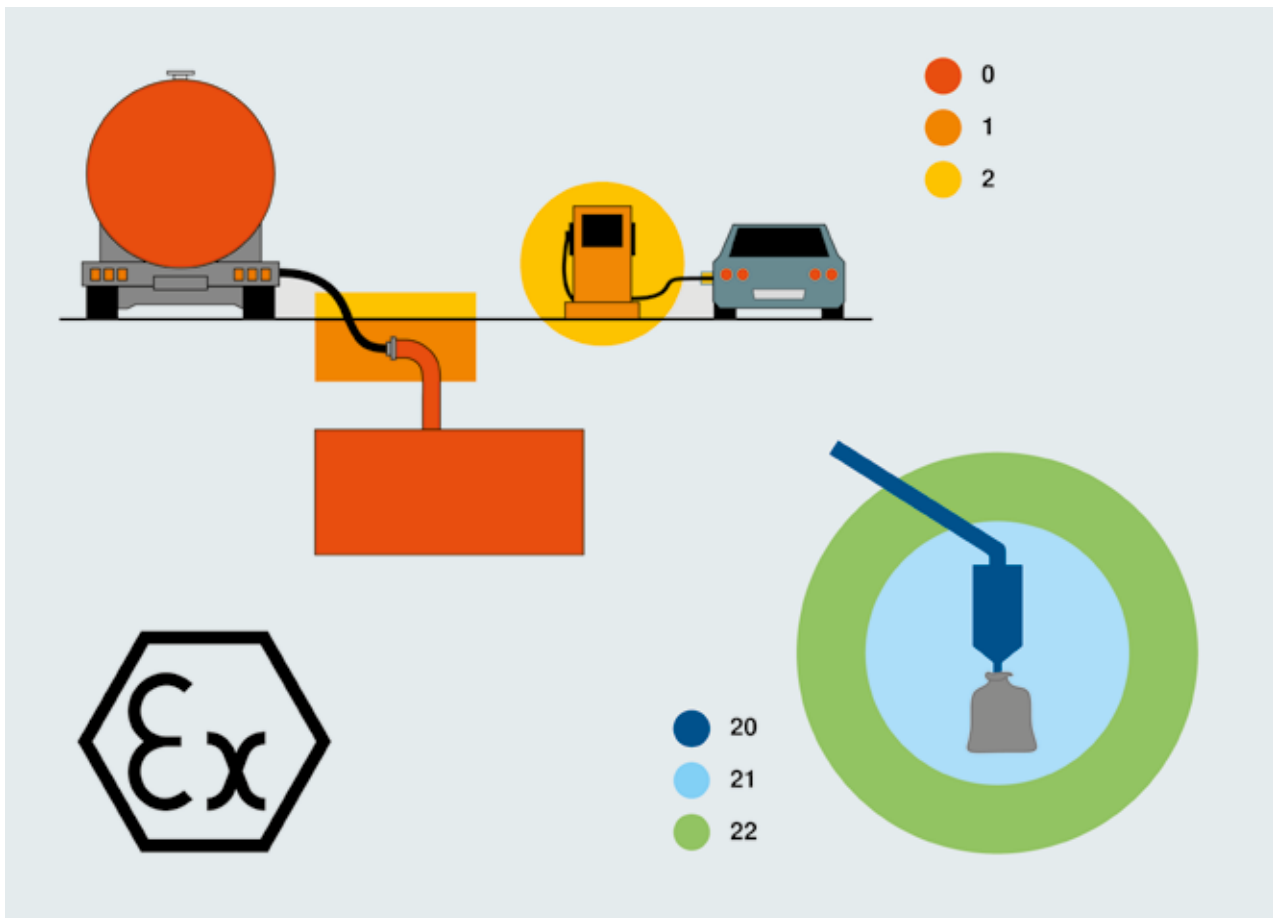

Products used in potentially explosive areas must comply with the ATEX directives. The ATEX workplace directive 1999/92/EC sets out the minimum requirements for improving the safety and health protection of workers at risk from potentially explosive atmospheres. The direc-

tive divides areas with dangerous, potentially explosive atmospheres into zones. Ex-tested products may be used in the respective zones in accordance with their approval.

Zone allocation of device group II (applied)

Gas	Dust
Explosive gas atmosphere, zone division to DIN EN 60079-10	Explosive dust-air mixtures, zone division to DIN EN 61214-10
Zone 0	Zone 20
An area in which it can be expected that, under normal conditions, an explosive atmosphere of gas occurs continuously or for long periods of time.	An area in which it can be expected that, under normal conditions, an explosive atmosphere of dust/air occurs continuously or for long periods of time.
Zone 1	Zone 21
An area in which it can be expected that, under normal conditions, an explosive atmosphere of gas occasionally occurs.	An area in which it can be expected that, under normal conditions, an explosive atmosphere of dust/air occasionally occurs.
Zone 2	Zone 22
Area, in which it can be expected that, under normal conditions, an explosive atmosphere of gas seldom or only briefly occurs.	Area, in which it can be expected that, under normal conditions, an explosive atmosphere of dust/air seldom or only briefly occurs.

Cable sizes

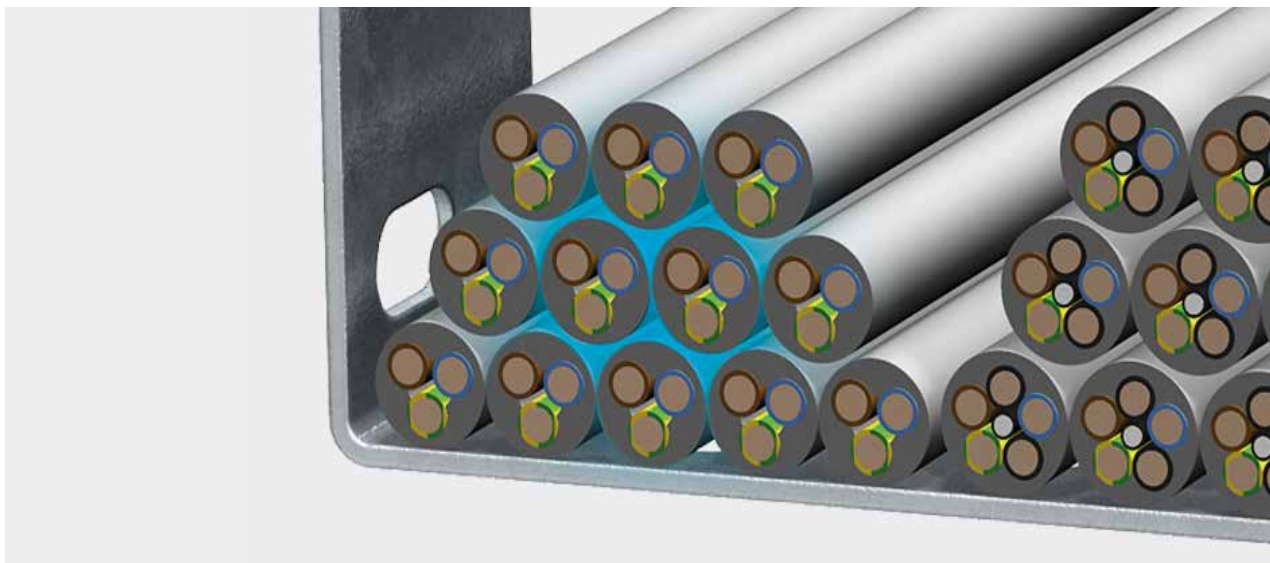

The term “cable” means a jacketed electrical cable for the transmission of electrical energy and data. Cables are given according to their nominal cross-section. The external diameter and usable cross-section depend on their nominal cross-section and the number of individual wires contained in the cable. When fastening clips or ca-

ble support systems are used, it is important to know the actual space requirements of the individual cables. It is not sufficient to take only the diameter as a basis for the calculation of the cable volume.

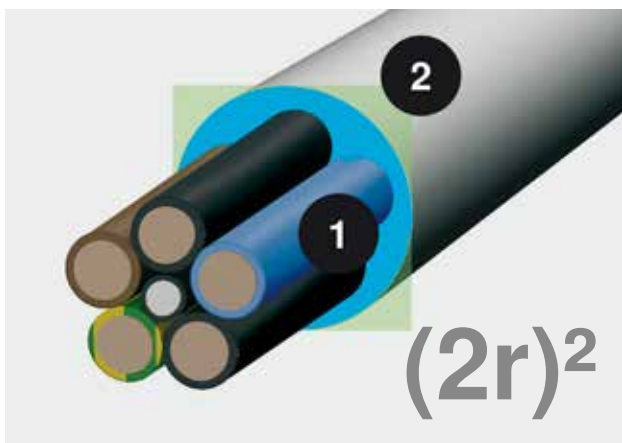

Circular area (1) and space required (2)

Calculation with the formula $(2r)^2$

The circular area of the cable cross-section says little about the actual space required by a cable. Calculate: $(2r)^2$. This value reflects the realistic space requirements, including the compartments.

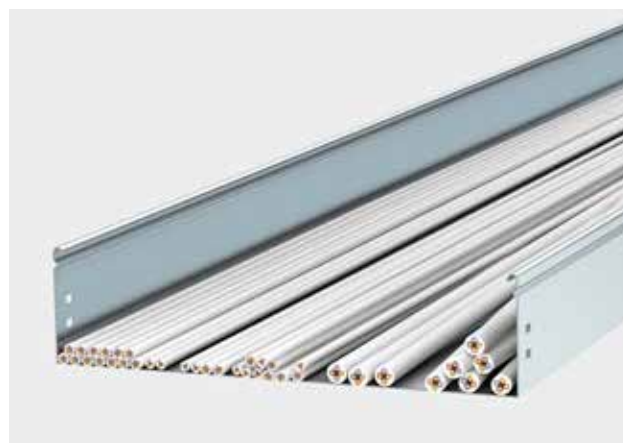

To save you work, we have listed the diameter and usable cross-section of the most important cable types below.

Important:

These values are average values, which may vary from manufacturer to manufacturer. Please refer to the manufacturer's specifications for the exact values.



Basic values for calculation of the cable volume

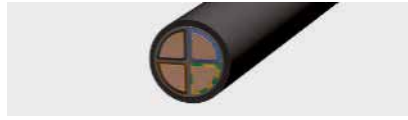
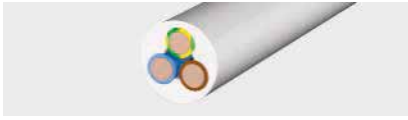

Insulated power cables

Type	Diameter mm	Usable cross-section cm ²
1 x 4	6.5	0.42
1 x 6	7	0.49
1 x 10	8	0.64
1 x 16	9.5	0.9
1 x 25	12.5	1.56
3 x 1.5	8.5	0.72
3 x 2.5	9.5	0.9
3 x 4	11	1.21
4 x 1.5	9	0.81
4 x 2.5	10.5	1.1
4 x 4	12.5	1.56
4 x 6	13.5	1.82
4 x 10	16.5	2.72
4 x 16	19	3.61
4 x 25	23.5	5.52
4 x 35	26	6.76
5 x 1.5	9.5	0.9
5 x 2.5	11	1.21
5 x 4	13.5	1.82
5 x 6	14.5	2.1
5 x 10	18	3.24
5 x 16	21.5	4.62
5 x 25	26	6.76
7 x 1.5	10.5	1.1
7 x 2.5	13	1.69

Insulated power cables

Type	Diameter mm	Usable cross-section cm ²
1 x 10	10.5	1.1
1 x 16	11.5	1.32
1 x 25	12.5	1.56
1 x 35	13.5	1.82
1 x 50	15.5	2.4
1 x 70	16.5	2.72
1 x 95	18.5	3.42
1 x 120	20.5	4.2
1 x 150	22.5	5.06
1 x 185	25	6.25
1 x 240	28	7.84
1 x 300	30	9
3 x 1.5	11.5	1.32
3 x 2.5	12.5	1.56
3 x 10	17.5	3.06
3 x 16	19.5	3.8
3 x 50	26	6.76
3 x 70	30	9
3 x 120	36	12.96
4 x 1.5	12.5	1.56
4 x 2.5	13.5	1.82
4 x 6	16.5	2.72
4 x 10	18.5	3.42
4 x 16	21.5	4.62
4 x 25	25.5	6.5
4 x 35	28	7.84
4 x 50	30	9
4 x 70	34	11.56
4 x 95	39	15.21
4 x 120	42	17.64
4 x 150	47	22
4 x 185	52	27
4 x 240	58	33.6
5 x 1.5	13.5	1.82
5 x 2.5	14.5	2.1
5 x 6	18.5	3.42
5 x 10	20.5	4.2
5 x 16	22.5	5.06
5 x 25	27.5	7.56
5 x 35	34	11.56
5 x 50	40	16

Telecommunications cables

Type	Diameter mm	Usable cross-section cm ²
2 x 2 x 0.6	5	0.25
4 x 2 x 0.6	5.5	0.3
6 x 2 x 0.6	6.5	0.42
10 x 2 x 0.6	7.5	0.56
20 x 2 x 0.6	9	0.81
40 x 2 x 0.6	11	1.12
60 x 2 x 0.6	13	1.69
100 x 2 x 0.6	17	2.89
200 x 2 x 0.6	23	5.29
2 x 2 x 0.8	6	0.36
4 x 2 x 0.8	7	0.49
6 x 2 x 0.8	8.5	0.72
10 x 2 x 0.8	9.5	0.9
20 x 2 x 0.8	13	1.69
40 x 2 x 0.8	16.5	2.72
60 x 2 x 0.8	20	4
100 x 2 x 0.8	25.5	6.5
200 x 2 x 0.8	32	10.24



IT cables type Cat...

Type	Diameter mm	Usable cross-section cm ²
Cat. 5	8	0.64
Cat. 6	8	0.64



Coax cable (Standard)

Type	Diameter mm	Usable cross-section cm ²
SAT/BK cable	6.8	0.48

Fastening clips



Fastening clips are given with their maximum span distance as a nominal size in mm. This makes it easy to determine the appropriate clip for the planned cable volume. If the necessary clamping range is between two nominal sizes, e.g. 16 mm, we recommend using the smaller nominal size.

If cables are not fastened directly in the clip, but routed through an installation pipe for example, the relationship between the external diameter and metric or PG sizes must be observed when selecting the correct fastening clip. You will find more information on this in the table below.

Overview of external diameters, metric and PG sizes

External diameter in mm	Metric size	PG size
Up to 12	M12	PG 7
Up to 16	M16	PG 9/PG 11
Up to 20	M20	PG 13.5/ PG 16
Up to 25	M25	PG 21
Up to 32	M32	PG 21
Up to 40	M40	PG 36
Up to 50	M50	PG 42/PG 48
Up to 63	M63	-





Selection of the correct cable support system



When selecting the right cable support system, the cable volume is not the only decisive factor. The type of cabling, method of laying and cable weight all play an important role. The most important aspects are explained on the following pages.

Cable types

Not all cables are the same. To select the perfect cable support system, you need to know which type of cables are to be laid: Are they sensitive data cables, which must be laid at a certain distance from each other on account of the necessary shielding? Or power cables, for which a not inconsiderable heat build-up must be taken? For all these applications OBO can offer tailor-made system solutions.

System types



Universal cable trays

Areas of application: from low-voltage cabling to power supply.



Mesh cable trays for the installation of light cables

Areas of application: IT cabling, telephone cabling and control cables. Also suitable for use in false ceilings and cavity floors.



Cable ladders for power cables with a large cross-section

Areas of application: (power) cables with large cross-sections. These can be fastened to the rungs using U clamps. The large load capacity and good ventilation ensure perfect cable routing.



Wide span cable trays and ladders for large support distances

Areas of application: for installations in which the support distances are more than three metres, on account of the construction conditions.



Modular system for special tasks

The product range that knows no bounds. The range of individually combinable products is particularly suited to complex installation tasks.



AZ small duct for universal use

Areas of application: from luminaire support systems to low-voltage cabling and power supply.



Finding the appropriate system for the planned cable volume



Cable height

The cable height may not exceed the edge height of the cable tray.



Volume reserve

When selecting the system, a volume reserve of at least 30% should be planned for possible later installations.

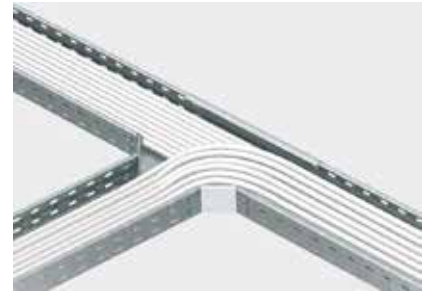

Branches

When dimensioning branches, the bending radii of the cables must be taken into account.



Separation of system levels

When selecting the volume, pay attention to the different cables. To separate different voltage levels, you must take the required spacings into account.



Same usable cross-section, different requirements

There are different requirements for laying data and power cables. Even if the usable cross-section or cable volume is the same, data cables tend to have a narrow, high tray, whereas power cables require a wide, flat version, to avoid heat build-up.



Examples

Flat, wide variant:

- E.g. for power cables
- Cable tray width: 300 mm
- Side height: 35 mm
- Usable cross-section: 103 cm² e.g. for data cables
- Cable tray width: 100 mm
- Side height: 110 mm
- Usable cross-section: 108 cm²

Calculating the cable load



100 mm = 15 kg/m



100 mm = 15 kg/m



100 mm = 15 kg/m



100 mm = 15 kg/m



100 mm = 15 kg/m



100 mm = 15 kg/m

Of equal significance for the selection of the most suitable cable support system is the load capacity. This must be matched with the expected cable weight (including the reserve for later installation). There are three variants for determining the cable weight:

Variant 1: Orientation to experience values

The average load capacity of a cable tray can be calculated roughly using experience values. For a system with a rail height of 60 mm, a value of 15 kg per 100 mm width is valid for each metre of cable tray or cable ladder. However, more accurate than orientation to experience values is to calculate the cable load using the formula from DIN VDE 0639 Part 1 (Variant 2) or the manufacturer's specifications (Variant 3). The graphics show the load capacities, based on experience values, of cable trays with a rail height of 60 mm, relative to cable tray widths of 100 to 600 mm.

Variant 2: Calculation formula according to VDE 0639 T1

DIN VDE 0639 Part 1 (cable support systems) offers a formula for calculating the maximum permitted cable load.

In the example calculation below, the maximum approved cable load for a cable tray is worked out using the dimension 60 mm x 300 mm and a usable cross-section of 178 cm².

Variant 3: Exact calculation according to manufacturer's specifications

Most cable manufacturers offer a very accurate method of calculating cable weights, and appropriate lists or tables can be obtained from them. Important: The table below only provides a rough overview. They are average values, which may vary from manufacturer to manufacturer. Please refer to the manufacturer's specifications for the exact values.

	0.028 N	
Cable load (F) =	-----	x Usable cross-section
	m x mm ²	

	0.028 N	
1. Cable load (F) =	-----	x 17,800 mm ² = 500 N/m
	m x mm ²	

2. Conversion from Newtons (N) to kilogrammes (kg)
10 N ~ 1 kg – in our example, this means: 500 N/m = 50 kg/m

3. Maximum occurring load = 50 kg/m



Actual cable load of different cable types

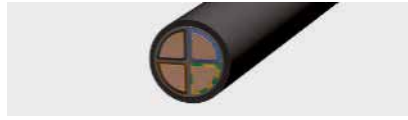
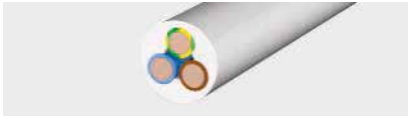

Insulated power cables

Type	Cable load kg/m
1 x 4	0.08
1 x 6	0.105
1 x 10	0.155
1 x 16	0.23
1 x 25	0.33
3 x 1.5	0.135
3 x 2.5	0.19
3 x 4	0.265
4 x 1.5	0.16
4 x 2.5	0.23
4 x 4	0.33
4 x 6	0.46
4 x 10	0.69
4 x 16	1.09
4 x 25	1.64
4 x 35	2.09
5 x 1.5	0.19
5 x 2.5	0.27
5 x 4	0.41
5 x 6	0.54
5 x 10	0.85
5 x 16	1.35
5 x 25	1.99
7 x 1.5	0.235
7 x 2.5	0.35

Insulated power cables

Type	Cable load kg/m
1 x 10	0.18
1 x 16	0.24
1 x 25	0.35
1 x 35	0.46
1 x 50	0.6
1 x 70	0.8
1 x 95	1.1
1 x 120	1.35
1 x 150	1.65
1 x 185	2
1 x 240	2.6
1 x 300	3.2
3 x 1.5	0.19
3 x 2.5	0.24
3 x 10	0.58
3 x 16	0.81
3 x 50	1.8
3 x 70	2.4
3 x 120	4
4 x 1.5	0.22
4 x 2.5	0.29
4 x 6	0.4
4 x 16	1.05
4 x 25	1.6
4 x 35	1.75
4 x 50	2.3
4 x 70	3.1
4 x 95	4.2
4 x 120	5.2
4 x 150	6.4
4 x 185	8.05
4 x 240	11
5 x 1.5	0.27
5 x 2.5	0.35
5 x 6	0.61
5 x 10	0.88
5 x 16	1.25
5 x 25	1.95
5 x 35	2.4
5 x 50	3.5

Telecommunications cables

Type	Cable load kg/m
2 x 2 x 0.6	0.03
4 x 2 x 0.6	0.035
6 x 2 x 0.6	0.05
10 x 2 x 0.6	0.065
20 x 2 x 0.6	0.11
40 x 2 x 0.6	0.2
60 x 2 x 0.6	0.275
100 x 2 x 0.6	0.445
200 x 2 x 0.6	0.87
2 x 2 x 0.8	0.04
4 x 2 x 0.8	0.055
6 x 2 x 0.8	0.08
10 x 2 x 0.8	0.115
20 x 2 x 0.8	0.205
40 x 2 x 0.8	0.38
60 x 2 x 0.8	0.54
100 x 2 x 0.8	0.875
200 x 2 x 0.8	1.79



Coax cable (standard)

Type	Cable load kg/m
SAT/BK cable	0.06



IT cables type Cat...

Type	Cable load kg/m
Cat. 5	0.06
Cat. 6	0.06

Finding the appropriate system for the cable load

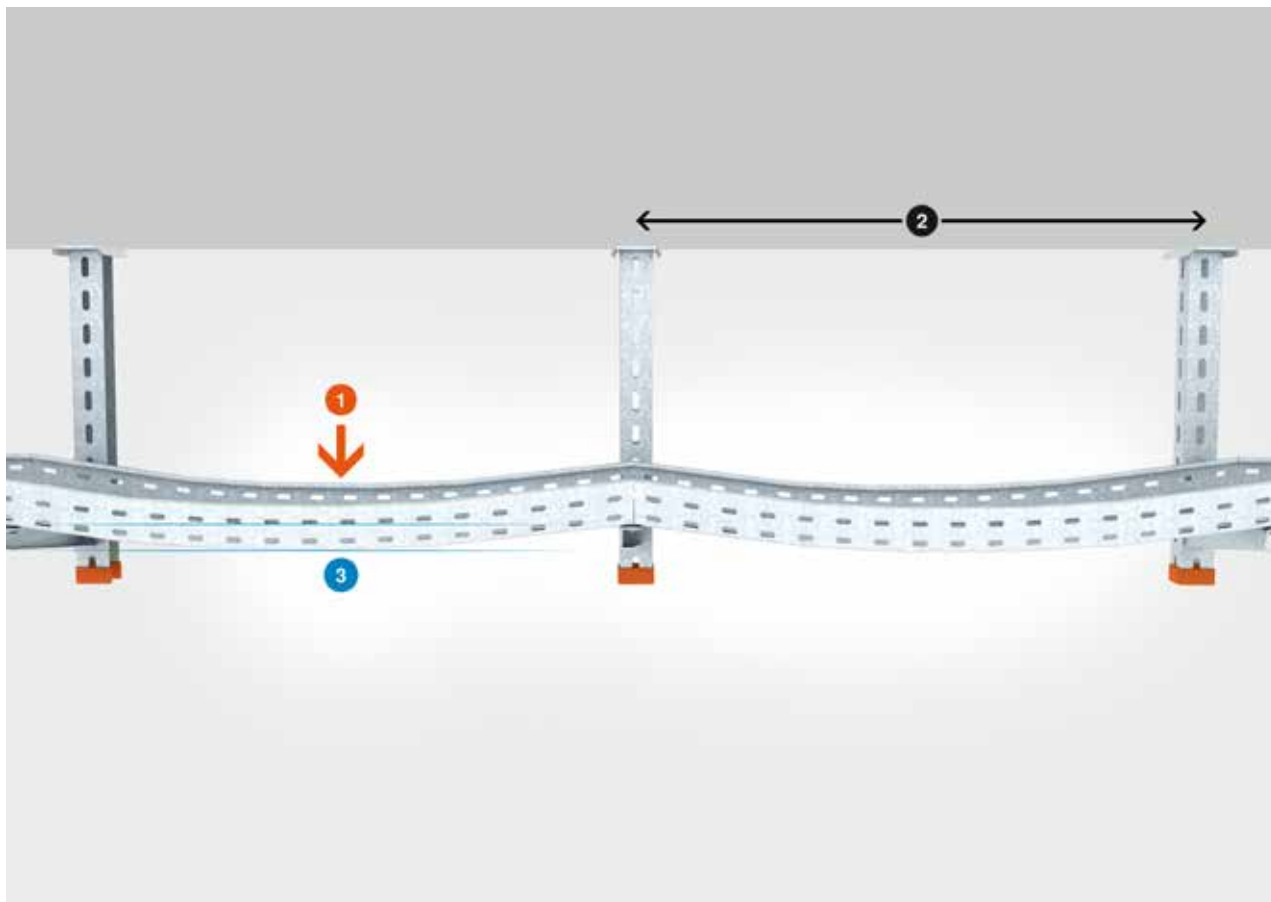

Explanation of the pictograms: 1 = Load in kN without human weight, 2 = Support width in m, 3 = Strut bend in mm

Load tests for cable support systems

All OBO products and systems are subjected to practical load testing. The basic principles for the tests of OBO cable support systems is DIN EN 61537 and DIN VDE 0639. After the load test, the maximum load capacity can be determined for each component, depending on the support distances and specific article parameters, such as component dimensions. This is all shown in a chart, included with each component.

You can find additional information on the load tests for cable trays, brackets and suspended supports on the following pages. The values given do not take resistance against environmental forces such as snow, wind and other outside influences into account.



Finding the appropriate system for the cable load

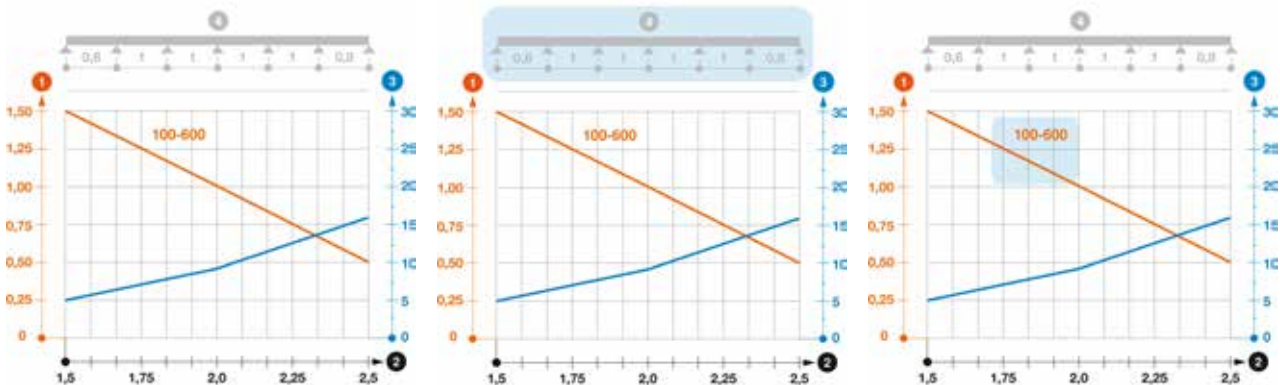

Load diagram legend

- 1 = Load in kN/m without human weight
- 2 = Support width in m
- 3 = Strut bending in mm
- 4 = Schematic diagram of the support widths for the testing process
- = Approved load depending on support width for the different tray widths
- = Rail bend depending on support width

Information 1: The testing process

The basic principles of the tests of OBO cable support systems is VDE 0639 Part 1 and DIN EN 61537. The purpose of the tests is to determine the maximum load capacities for each component, depending on parameters such as component width, support spacing, etc. and to present this in a diagram to be included with each component. The area highlighted in blue in the above example schematises the experiment set-up with a variable support spacing (L) in the central area and a factor of $0.8 \times L$ at the front and rear ends of the cable tray.

Information 2: Load curves for selected cable tray or cable ladder widths

The load capacity of the cable trays according to the support width can be read off in the diagram using the load curves – this is an example for a cable tray for the tray widths 100 to 600 mm. It may occur that, in the load curves, width differences must be made, allowing multiple curves to be visible simultaneously in the diagram. A key factor for the load capacity of the cable trays is, beside the support spacing and side height, the material thickness, which varies according to type.

Finding the appropriate system for the cable load

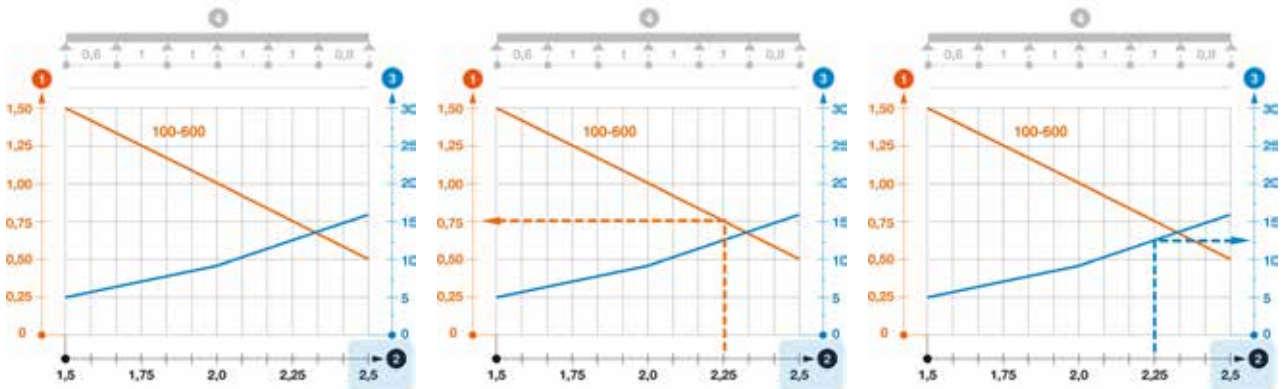

Information 3: Possible support spacings

The theoretically possible support spacings for the cable tray can be read off on the axis at the foot of the table. Using the load curves, it is easy to read off to what extent the load capacity of the system falls as the support spacing grows. On all OBO cable support systems (with the exception of the wide span trays), we recommend not exceeding a support spacing of 1.5 m if possible.

Information 4: Ratio: load/span

Which load is possible at which support spacing? With the diagram, you can find the appropriate information at a glance. In our example (with the blue background) a span of 2.25 m for the cable tray produces a maximum load capacity of 0.75 kN for each running metre of cable tray. Please note that, in this example, the volume of the cable tray may exceed the permitted load. Therefore, if at all possible, do not exceed the support spacing of 1.5 m, as recommended by OBO.

Information 5: $W =$ Rail bending

To what extent does the load on a cable tray cause the rail to bend? This information is supplied by the blue curve (w) in millimetres (orientation values on the axis on the right-hand side of the diagram).

The course of the blue curve clearly shows how quickly the cable tray will sag as the support spacing increases. In our example, the bend at a support spacing of 2.25 m is shown, here approximately 12 mm.



Finding the appropriate bracket for the cable load

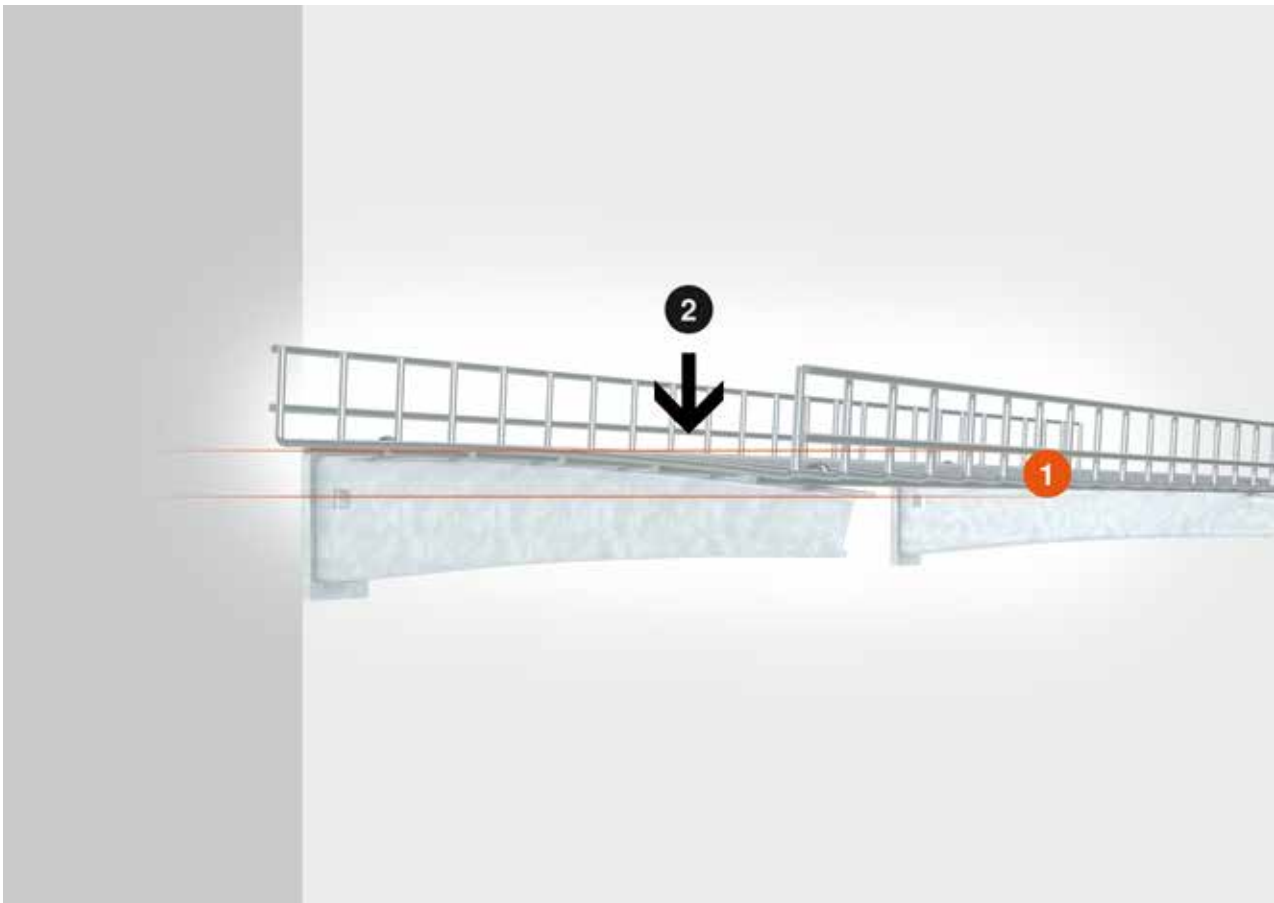

Key component of the OBO cable support systems are the mounting components, in particular the brackets and suspended supports. They connect the cable trays and ladders to the wall and to the ceiling, and are thus an important construction element of the overall system. When calculating the load capacity of a cable support system, the brackets and suspended supports must not be forgotten. The test diagram is also useful in selecting the right products.

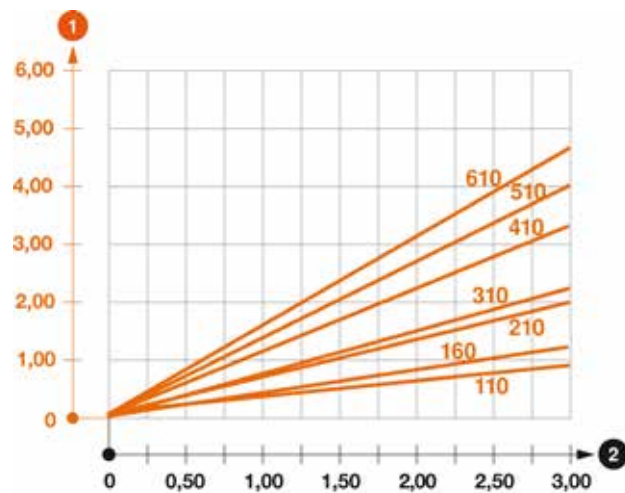

Load diagram legend

- 1 = Bend in mm at the bracket tip
- 2 = Load in kN/m without human weight
- = Load curves for the various bracket lengths

Finding the appropriate bracket for the cable load

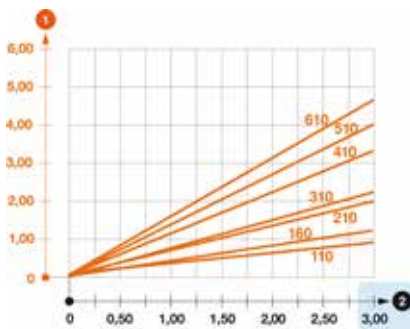

Information 1: Recommended maximum load of the brackets

The bracket is the part of the installation system upon which the cable tray or mesh cable tray is located. It is either directly connected to the wall or is connected to the ceiling using supports. The grey bar on the right edge of the diagram provides information on the maximum load capacity of the bracket.

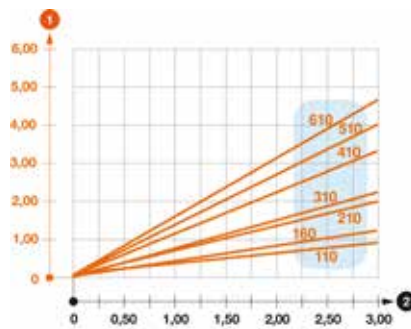

Information 2: Load curves for all bracket widths

The bending of the bracket is dependent on its width, which, in our example, can range from 110 mm to 610 mm. The load curves are assigned to the appropriate bracket type.

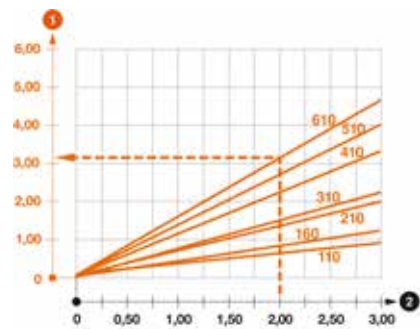

Information 3: Bending of the bracket tip at a specific load

The load curve in the diagram provides information on the bending of the boom tip at a specific load. In our example (dotted orange line), a 610 mm-wide bracket with a load of 2 kN bends by approx. 3.1 mm. A basic rule of thumb is: The shorter the bracket, the less the bend will be.

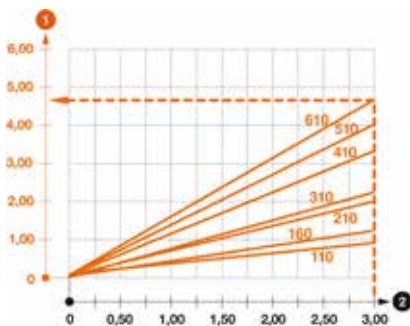

Information 4: Bending of the bracket tip at maximum load

The bending factor of the bracket at maximum load can also be seen in the diagram. In our example (shown in orange), the bend value for a 610 mm-wide bracket at a maximum load of approx. 3.0 kN is approximately 4.5 mm. To minimise the bend, the centre of gravity of the cable load should be as close as possible to the wall or the support fastening.

Finding the appropriate support for the cable load

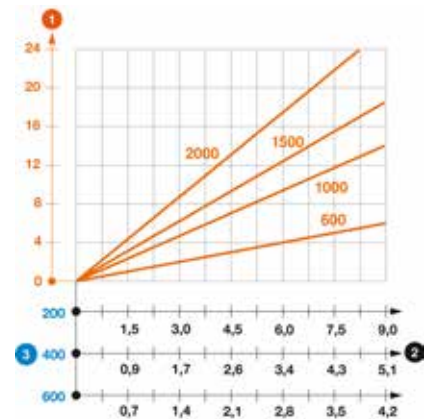

Load diagram legend

- 1 = Bend in mm at the bracket tip
- 2 = Load in kN/m without human weight
- = Load curves for the various bracket lengths

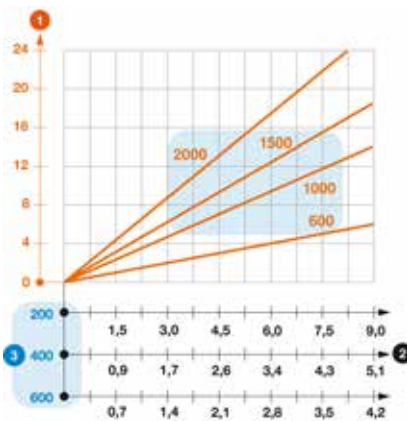

Information 1: Various support lengths and bracket widths

The load capacity of a cable support system is not just dependent on the width of a bracket, but also on the length of a suspended support. The load curves in the diagram provide information on the load capacity of a suspended support of length 600, 1,000, 1,500 or 2,000 mm, taking the bracket width into account.

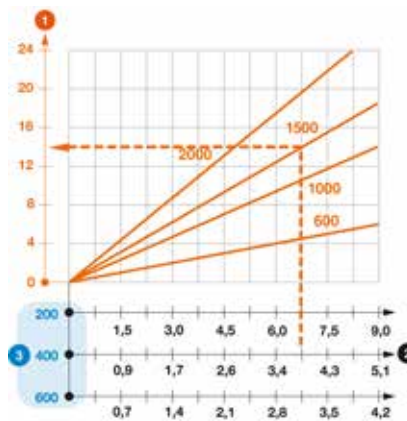

Information 2: Calculation of the deflection for the example

The weight of the total suspended support/bracket/cable tray system causes an excursion of the suspended support from the vertical. The excursion value can be read off from the axis on the left edge of the diagram. In our example (blue background), a 1,500 mm-long suspended support, together with a 400 mm-wide bracket and a weight load of 4 kN at the end of the support will produce a deflection of approximately 14 mm.

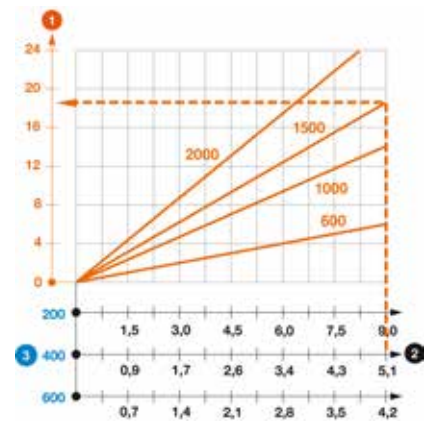

Information 3: Calculation of the excursion at maximum load for the example

The deflection of the suspended support at a maximum load can also be read off on the diagram. Our blue example shows a deflection of roughly 18 mm at the end of the support for a 1,500 mm-long suspended support in combination with a 400 mm-wide bracket at a maximum cable load of approximately 5 kN.

Cable glands and DIN EN 50262

Cable glands are manufactured and tested according to DIN EN 62444. Amongst other things, this standard controls the retaining ability and strain relief of cables. The V-TEC cable glands from OBO Bettermann correspond to version "A". Table 2A indicates the extraction forces that these cable glands must be able to withstand, according to the standard. The V-TEC cable glands also fulfil the requirements of DIN EN 62444 with regard to the twist protection of cables (see Table 3). To ensure the

tested dust and moisture protection of the cable glands, continuous perforations should correspond to the mounting openings specified in the standard DIN EN 62444 according to Table 1. The on-site specialist must ensure that these parameters are complied with in order to hand over a functioning system.

Table 1

Size of the penetration hole	mm	6	8	10	12	16	20	25	32	40	50	63	75
Thread of the cable gland	M	M6	M8	M10	M12	M16	M20	M25	M32	M40	M50	M63	M75
Diameter of the mounting hole (+0.2/-0.4)	mm	6.5	8.5	10.5	12.5	16.5	20.5	25.5	32.5	40.5	50.5	63.5	75.5

Table 2 A

Cable diameter	Retaining capacity	Strain relief, version A
mm	N	N
to 4	5	--
>4 to 8	10	30
>8 to 11	15	42
>11 to 16	20	55
>16 to 23	25	70
>23 to 31	30	80
>31 to 43	45	90
>43 to 55	55	100
>55	70	115

Table 3

Cable diameter	Torque Version A and B
mm	Nm
>4 to 8	0.10
>8 to 11	0.15
>11 to 16	0.35
>16 to 23	0.60
>23 to 31	0.80
>31 to 43	0.90
>43 to 55	1.00
>55	1.20

Information on cable fastening



Cable fastening

The standard DIN EN 61914 “Cable holders for electrical installations” specifies that cable holders “must be able to accept cables or cable bundles of the diameter specified by the manufacturer or responsible retailer, without tearing or breaking or shearing off the threads of bolts”. During the installation of cables, the current national and international standards must be taken into account, such as DIN VDE 0100 520. “Suitable tools and methods, which prevent damage or changes to the shape” must be used for fastening.

In addition, with masses of cables, DIN VDE 0298 requires the appropriate “load capacities of cables for fixed laying in and on buildings...” to be taken into account when selecting the fastening systems.

Besides these standardising aspects, the end customer’s or client’s particular laying specifications can/must be

taken into account.

The fastening spacing for cables is given in DIN VDE 0100-520, June 2003. For example, cables laid horizontally require a spacing of 20x the cable diameter. However, a spacing of 80 cm should not be exceeded. With vertical laying, the clip spacings may be increased but should not exceed 1.5 m.

The table below shows the maximum fastening spacings for cables according to the cable diameter. The laying spacings given in the “Industrial installations” product catalogue, e.g. for bus holders or Quick clips, are guide values and can only be treated as such.

External diameter of the cables mm	Maximum spacing for horizontal fastening mm	Maximum spacing for vertical fastening mm
$D \leq 9$	250	400
$9 < D \leq 15$	300	400
$15 < D \leq 20$	350	450
$20 < D \leq 40$	400	550



Classification of installation pipes (according to DIN EN 61386-1)



The OBO Bettermann pipe systems are machined and tested according to DIN EN 61386 (Electrical installation pipe systems for electrical energy and information) and DIN EN 60423 (External diameters of electrical installation pipes and thread for electrical installation pipes and their accessories).

Numeric code

DIN EN 61386-1 classifies installation pipes using a 12-digit numeric code, which provides information on the pressure resistance, impact resistance or use temperatures. You can find the first five digits in the product descriptions of the pipe systems.

	First digit		Second digit		Third digit		Fourth digit		Fifth digit
	Pressure resistance		Impact resistance		Minimum use temperature		Maximum use temperature		Bending behaviour
1	Very light (125 N)	1	Very light (0.5 kg/100 mm)	1	+ 5 °C	1	+ 60 °C	1	Rigid
2	Light (320 N)	2	Light (1.0 kg/100 mm)	2	- 5 °C	2	+ 90 °C	2	Bendable
3	Medium (750 N)	3	Medium (2.0 kg/100 mm)	3	- 15 °C	3	+ 105 °C	3	Bendable, self-healing
4	Heavy (1250 N)	4	Heavy (2.0 kg/300 mm)	4	- 25 °C	4	+ 120 °C	4	Flexible
5	Very heavy (4000 N)	5	Very heavy (6.8 kg/300 mm)	5	- 45 °C	5	+ 150 °C		
						6	+ 250 °C		
						7	+ 400 °C		

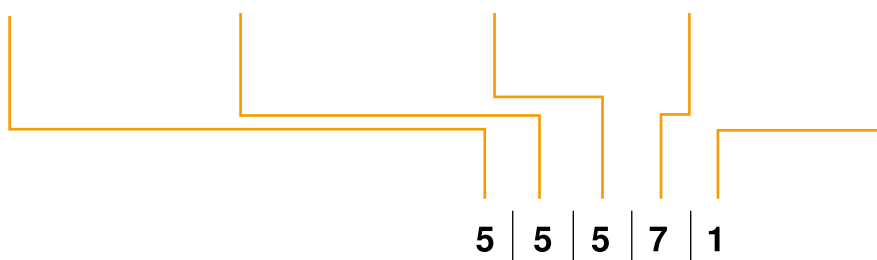



Classification according to IEC EN 61386-1: Corrosion protection

	Resistance against corrosion	Suitable surfaces
1	Low protection, inside and outside	
2	Medium protection, inside and outside	<ul style="list-style-type: none"> • Painted black (SW) • Electrogalvanised (G) • Strip galvanised (FS)
3	Medium protection inside, high protection outside	
4	High protection, inside and outside	<ul style="list-style-type: none"> • Hot-dip galvanised (FT) • Stainless steel (V2A, V4A)



Protection against mechanical loads

OBO metal pipes are particularly suited to use under tough industrial conditions. They provide reliable protection against very heavy mechanical loads during cable routing.

The different material and surface qualities, from galvanised to painted, allow perfect adaptation to the requirements of the appropriate environment.

Maintenance of electrical function E30/E90

Our steel pipes guarantee the maintenance of electrical function to E30/E90. They are thus ideal for the connection of safety-relevant equipment, such as fire alarm systems.

Definition of electromagnetic compatibility (EMC)

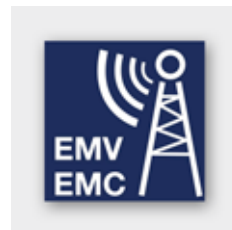

In recent years, the use of electronic circuits has increased continually. Whether in industrial systems, medicine, households, telecommunications systems or electrical building installations – we find powerful electrical equipment and systems everywhere, and these switch ever greater currents, achieve greater radio ranges and transport ever more power in smaller spaces. However, the use of state-of-the-art technology means that the complexity of applications also increases. The consequence of this is that ever more opposing influences (electromagnetic interferences) can occur from system parts and cables, causing damage and economic losses.

Here, we talk of electromagnetic compatibility.

Electromagnetic compatibility (EMC) is the ability of an electrical unit to function satisfactorily in its electromagnetic environment, without inappropriately influencing this environment, to which other units also belong (VDE 0870-1). In terms of standardisation, electromagnetic compatibility is dealt with by the EMC directive 2004/108/EC. This means that electrical resources emit electromagnetic interferences (emissions), which are picked up by other devices or units (immision) that act as receivers (interference sink). This, in turn, means that the function of an interference sink can be severely reduced, and, in the worst-case scenario, total failure and economic losses. The interferences can then spread along cables or in the form of electromagnetic waves.

Path of faults

Fault source (transmitting emissions)	Coupling of interference variables (spreading of interference)	Fault sink (receiving emissions)
For example - Mobile telephones - Switching components - Ignition systems - Frequency converters - Lighting strike - Welding devices	- Galvanic - Inductive - Capacitive - Electromagnetic	- Process computer - Radio receiver systems - Controllers - Converters - Measuring units



Guaranteeing EMC



Guaranteeing EMC

A systematic planning process is necessary to guarantee EMC. The interference sources must be identified and quantified. The coupling describes the spread of the interference from the interference source up to the influenced device, the interference sink. The task of EMC planning is to ensure the compatibility at the source, coupling path and sink using suitable measures. During their daily work, planners and installation engineers are confronted with this subject on an increasingly regular basis. This means that EMC is a basic factor to be taken into consideration during the planning of installations and cabling systems. Due to the high complexity of electromagnetic compatibility, the problems of EMC must be analysed and solved using simplifying hypotheses and models as well as experiments and measurements.

Cable support systems and their contribution to EMC

Cable support systems can make an important contribution to the improvement of EMC. They are passive and can thus make a safe, long-lasting contribution to EMC through the fact that cables are run within cable support systems or are shielded by them.

Routing cables inside cable support systems greatly reduces the galvanic coupling and coupling due to electrical and magnetic fields in the cables.

Thus cable support systems can make a contribution to the reduction of coupling from the source to the sink. The shielding action of cable support systems can be quantified by the coupling resistance and the shield attenuation. This gives the planner important engineering parameters for cable support systems for the EMC engineering.

Lightning discharge

From the analysis of the effectiveness of EMC in buildings (EN 62305-4), we know that lightning discharge is one of the greatest sources of interference to be expected. This causes a direct current feed into the entire equipotential bonding system in the building and/or to magnetic decoupling of interference currents in electrical cables. With regard to these couplings, cable support systems can offer an effective contribution to the reduction of interference voltages.

Magnetic shield insulation of cable support systems

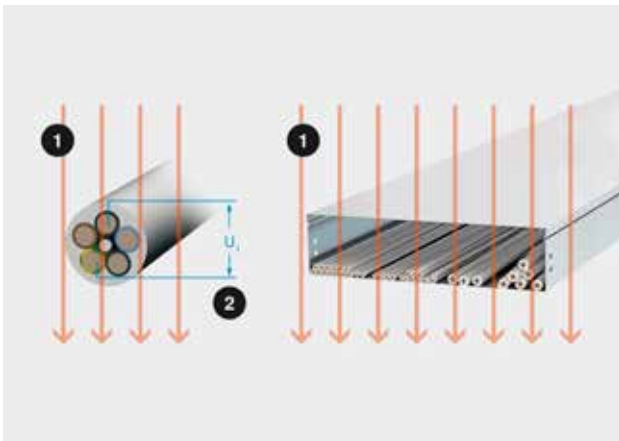

The magnetic field (H) of strength 3 kA/m in a defined experimental set-up: without cable support system on the left, with cable support system on the right. 1 = Field H, 2 = $V1 L_{zuPE}$



The magnetic shield insulation of cable support systems is the ratio in decibels (dB) of an induced voltage into an unprotected cable to the induced voltage into the same cable, when this is in a cable support system.

Experimental structure to determine the magnetic shield insulation of cable support systems:

An unshielded cable (NYM-J 5x6 mm²) is subjected to an 8/20 magnetic field with a strength of 3 kA/m. Here, the induced voltage V1 is measured in the unshielded cable. The same cable is then positioned in the centre of a cable support system (once with a cover, once without) and subjected to the same magnetic field of 3 kA/m. Here, the induced voltage V2 is measured in the unshielded cable. The magnetic shield insulation is calculated from the measured values according to the formula:

$$\alpha_S = 20 \log (V1/V2) \text{ dB}$$

Experiment result:

The magnetic shield effect α_S of a cable support system could be clearly proved by the experiments and the simulation with an FEM program. The best result of around 50 dB was achieved with cable support systems (cable trays) with covers.

Note:

The shield insulation against electrical fields is as it is with a Faraday cage, almost perfect.

Magnetic shield insulation 8/20 dB

Type, cable tray/cable ladder	Without cover	With cover
RKSM 630 FS	20	50
MKS 630 FS	20	50
MKS 630 FT	20	50
MKSU 630 FS	20	50
MKSU 630 FT	20	50
MKSU 630 VA	20	50
GRM 55/300 FS	15	34
LG 630 NS FT	10	15

Transfer impedance of cable support systems

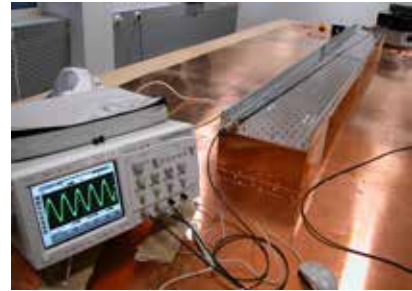
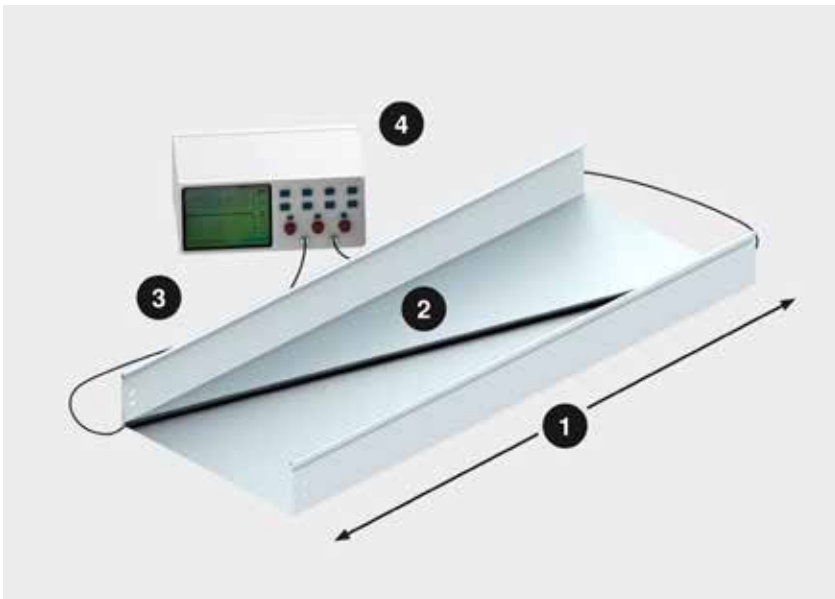

$$Z'_T = \frac{U_{\text{Stör}}}{I_{\text{Stör}} * L}$$

Experimental structure for transfer impedance: 1 = length l, 2 = U, 3 = I, 4 = pulse source 8/20

Z'_T : Transfer impedance
 $U_{\text{Interference}}$: Interference voltage measured in cable
 $I_{\text{Interference}}$: Interference current, fed into the shield from outside (KTS)
 L : Length of the cable support system

Transfer impedance (coupling resistant) of cable support systems

The transfer impedance of a cable support system is the ratio of the measured voltage $V_{\text{Interference}}$ measured in the lengthwise direction within the cable support system, to the coupled current $I_{\text{Interference}}$. The transfer impedance is determined in the same way as with the measurement of the electrical conductivity properties in Chapter 11.1. (DIN EN 61537). If there is a lightning strike on a building, partial currents will flow through the entire equipotential bonding system.

Installed cables are best run within a cable support system. Installed cable support systems are always included in the equipotential bonding system. In so doing, the partial current flows via the cable support system. A very small component can therefore still flow along the cables laid within the cable support system. This component is determined by the transfer impedance of the cable support system.

The following applies for the transfer impedance:

$$Z_T = V_{\text{Interference}} / (I_{\text{Interference}} \times L) \text{ [m}\Omega\text{/m]}$$

The values given are based on measurements, in which a pulse current of the wave shape 8/20 was passed through a defined length of a cable support system.

Experiment result:

The effect of the cable support system against galvanic coupling was clearly proved by the experiments. The best result was achieved with cable support systems (cable trays) with covers.

Transfer impedance 8/20 mOhm/m

Type, cable tray/cable ladder	Without cover	With cover
MKS 630 FS	1.14	0.71
MKS 630 FT	1.14	0.71
MKSU 630 FS	0.44	0.09
MKSU 630 FT	0.44	0.09
GRM 55/300 FS	6.17	5.5

Maintenance of the electrical supply



Safety in case of fire

To ensure that emergency and escape routes and important technical equipment such as emergency lighting, fire alarm systems and smoke exhaust systems remain usable in case of fire, it is absolutely essential to provide special protection for the power supply for these systems. The use of special cables and routing systems means that it is possible to maintain the power supply, even in the case of fire, thus guaranteeing the maintenance of electrical function.

You can find detailed information on the subject of fire protection in the OBO protective installation catalogue.

Maintenance of electrical function is particularly important in buildings regularly frequented by large numbers of people. These include public buildings such as schools, hospitals, meeting places, civic buildings and underground stations, but also industrial plants, high-rise buildings, shopping centres and large car parks.

Fire loads of installation systems

According to rules governing wiring systems in the individual German federal states, no fire loads may be installed in emergency and escape routes. OBO's fire-tested steel fastenings fulfil these requirements.



Junction boxes with integrated maintenance of electrical function ensure the fireproof connection of the safety cables. The boxes in the FireBox series are tested and approved for 30 to 90 minutes of the maintenance of electrical function in accordance with DIN 4102-12.





E30

30 minutes:

maintenance of electrical function for an evacuation.

The first 30 minutes after the start of a fire are decisive when clearing the affected building.

During this time, the maintenance of the electrical supply must be guaranteed for the following units:

- Safety lighting systems
- Lifts with fire control
- Fire alarm systems
- Alarm systems and systems to issue instructions to visitors and employees
- Smoke extraction systems

E90

90 minutes:

Maintenance of electrical function for better fire-fighting.

To support firefighting operations, it is imperative that certain technical equipment is supplied with sufficient power even up to 90 minutes after a fire breaks out in a building. This equipment includes:

- Systems to increase the pressure of the water for fighting the fire
- Mechanical smoke extraction and smoke protection pressure systems
- Fire brigade lifts, bed lifts in hospitals

Individual routing systems for the maintenance of electrical function

With the individual laying systems, OBO Bettermann can offer a range of practical, flexible mounting options for electrical installations with the maintenance of electrical function. The systems are suited to vertical and horizontal installation and are approved for the fire protection class-

es E30 to E90. Standardised supporting constructions as defined in the testing standard, DIN 4102 Part 12, include: The laying of cables with individual clips and the laying of cables with profile rail, clamp clip and a long trough.



Standard routing type, clamp clip, type 2056

Standard support construction consisting of clamp clip without long trough for individual laying or bundling cables.

- Wall or ceiling mounting
- Horizontal installation
- Rail mounting: Max. 0.3 m
- Anchor spacing in the rail: Max. 0.25 m
- Individual cable assignment: Diameters of up to 100 mm possible
- Assignment with bunched cables: Max. 3 cables with max. diameter 25 mm



Collecting clamp

Cable-specific laying type with cable ties for individual laying, horizontal/vertical mounting on wall or ceiling.

Type 2031/M 15

- Fastening distance: Max. 0.5 m
- Cable assignment: Max. 1.1 kg/m

Type 2031/M 30

- Fastening distance: Max. 0.5 m
- Cable assignment: Max. 2.5 kg/m

Type 2031/M 70

- Fastening distance: Max. 0.8 m
- Cable assignment: Max. 6.0 kg/m



E30

E60

E90

Standard routing type, single clip, type 732/733

Standard support construction consisting of spacer clips for individual laying or bundling cables.

- Wall or ceiling mounting
- Vertical or horizontal mounting
- Mounting spacing: Max. 0.3 m
- Individual cable assignment: Diameters of up to 50 mm possible
- Assignment with bunched cables: Max. 3 cables with max. diameter 25 mm



E30

Pressure clips

Cable-specific laying type with pressure clips for individual laying, mounting on the ceiling.

Type 2033 M

- Fastening distance: Max. 0.5 m

Type 2034 M

- Fastening distance: Max. 0.5 m

Standards, specifications and certifications



Standards

OBO offers products for professionals, made by professionals: Our products are manufactured and tested according to the respective specifications of the standards. For example, DIN EN 61537 describes all the relevant parameters for cable support systems, such as area of application, test conditions, corrosion resistance and temperature classification. As a competent manufacturer, OBO subjects itself to these requirements on a daily basis. Comprehensive test procedures guarantee that systems which conform to standards function safely.

Specifications

All the OBO products and systems are CE-compliant according to the appropriate EC guidelines. This also applies to standard parts such as bolts, washers and nuts that are components of various product systems. The appropriate EC declaration of conformity certifies agreement with the named directives or standards, but does not guarantee properties. The safety instructions in the product information and the general safety regulations must be complied with during installation and use.

Certifications

For OBO, product quality is closely connected to continuous testing and checking – which is why we manufacture almost all our products ourselves. This enormous depth of production is an expression of our demand for quality. From construction, and the materials used through production, right up to logistics, our employees personally guarantee the quality and availability of OBO products. The multitude of approvals emphasise our high demand for quality and product functionality.

Our integrated quality management system forms the solid basis of our ISO 9001 certification, which we have held since 1994. The confirmation of suitability enables defined and workable processes in accordance with KTA 1401 and 10 CFR 50.



Certificates and test marks



VDE

VDE is the Association for Electrical, Electronic and Information Technologies, their study and the technologies and applications based upon them. The VDE mark on electrical equipment is proof that the equipment complies with VDE regulations and/or European or international harmonised standards, and meets the safety requirements of the applicable directives. The VDE mark indicates that a product is safe in relation to electrical, mechanical, thermal, toxic, radiological and other hazards.

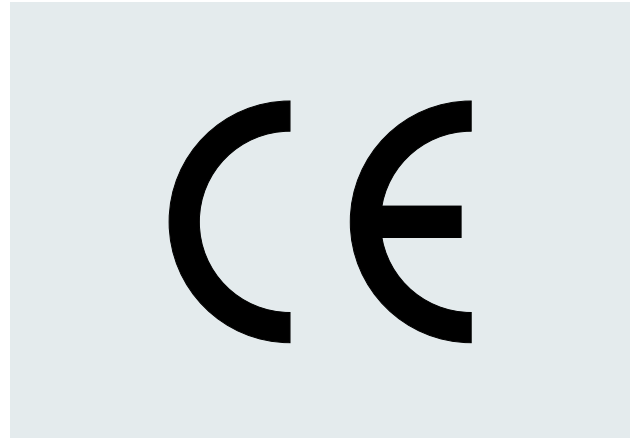

CE symbol

Technical resources included in a legal ordinance, i.e. electrical resources, machines and safety components, must have a CE symbol, with which the manufacturer confirms that the safety requirements of the ordinances are fulfilled. In addition, there must also be a declaration of conformity and technical documentation. The CE symbol is not a quality mark, but simply a declaration by the manufacturer that they have complied with the legal requirements and the codes of practice.





























UL

Underwriters Laboratories (UL) is an independent organisation that tests and certifies product safety. UL certification is generally required if a product is to be sold on the US market.



UL offers various certification options: the "UL Listed" test mark indicates that UL has tested representative samples of a product and that it conforms to UL's safety requirements. The "UL Recognized" component test mark entitles a product to be used in a product or system bearing the "UL Listed" test mark.

Every test mark at a glance

	American Bureau of Shipping, USA		AFNOR Quality symbol of the French standardisation institute
	AENOR, Producto Certificado, Spain		Underwriters Laboratories Inc., USA + CSA, Canada
	STOWARZYSZENIE ELEKTRYKÓW POLSKICH, Poland		Österreichischer Verband für Elektrotechnik, Austria
	Lightning current-tested		INSTITUTO ITALIANO DEL MARCHO DI QUALITÀ, Italy
	Lightning current-tested, Class H (100 kA)		RINA 1861, Ship Classification, Certification and Services
	CEBEC, Belgium		Underwriters Laboratories Inc., USA
	Canadian Standards Association, Canada		SEMKO An Inchcape Testing Services Company, Sweden
	DEMKO, Danmarks Elektriske Materielkontrol, Denmark		Eidgenössisches Starkstrominspektorat, Switzerland
	Deutsches Institut für Bautechnik Berlin, Germany		South African Bureau of Standards
	Det Norske Veritas		Shock-tested, Bundesamt für Zivilschutz, Germany
	ENEC Austria		Sähkötarvikeskeskus Elinspektionscentralen Electrical Inspectorate, Finland
	ATEX certificate for explosive areas		Underwriters Laboratories Inc., USA
	ELEKTROTECHNICKÝ ZKUŠEBNÍ ÚSTAV, Czech Republic		Underwriters Laboratories Inc., USA
	FIMKO, Finland		Verband der Elektrotechnik, Elektronik, Informationstechnik e.V., Germany
	Forschungs- und Materialprüfungsanstalt, Germany		German Association of Electricians, tested safety
	Russia, GOST The State Committee for Standards		5-year warranty
	Test marks for technical resources, tested safety		
	Halogen-free; without chloride, fluoride or bromine		
	INMETRO, Brazil		
	KEMA-KEUR, Netherlands		
	Labelling of metric products		
	MAGYAR ELEKTROTECHNIKAI ELLENŐRZŐ INTÉZET Budapest, Hungary		
	NEMKO, Norway		





First-hand support and knowledge



OBO KTS seminars: First-hand knowledge

With a comprehensive programme of training courses and seminars, OBO supports its customers with first-hand specialist knowledge. Besides the theoretical principles, practical everyday implementation is also dealt with. Special calculation and application examples round off the comprehensive programme of knowledge transfer.

Invitations to tender, product information and data sheets

We can make life easier for you, with our comprehensive selection of materials designed for practical applications, which provide you with effective support with the planning and calculation of a project. These include:

- Invitations to tender
- Product information
- Information sheets
- Data sheets

Invitations to tender on the Internet at www.ausschreiben.de

More than 10,000 entries can be accessed free of charge. Regular updates and extensions mean that you always have a comprehensive overview of the OBO products. All the current file formats (PDF, DOC, GAEB, HTML, TEXT, XML, ÖNORM) are available.
www.ausschreiben.de

OBO Construct – planning software and product configurators

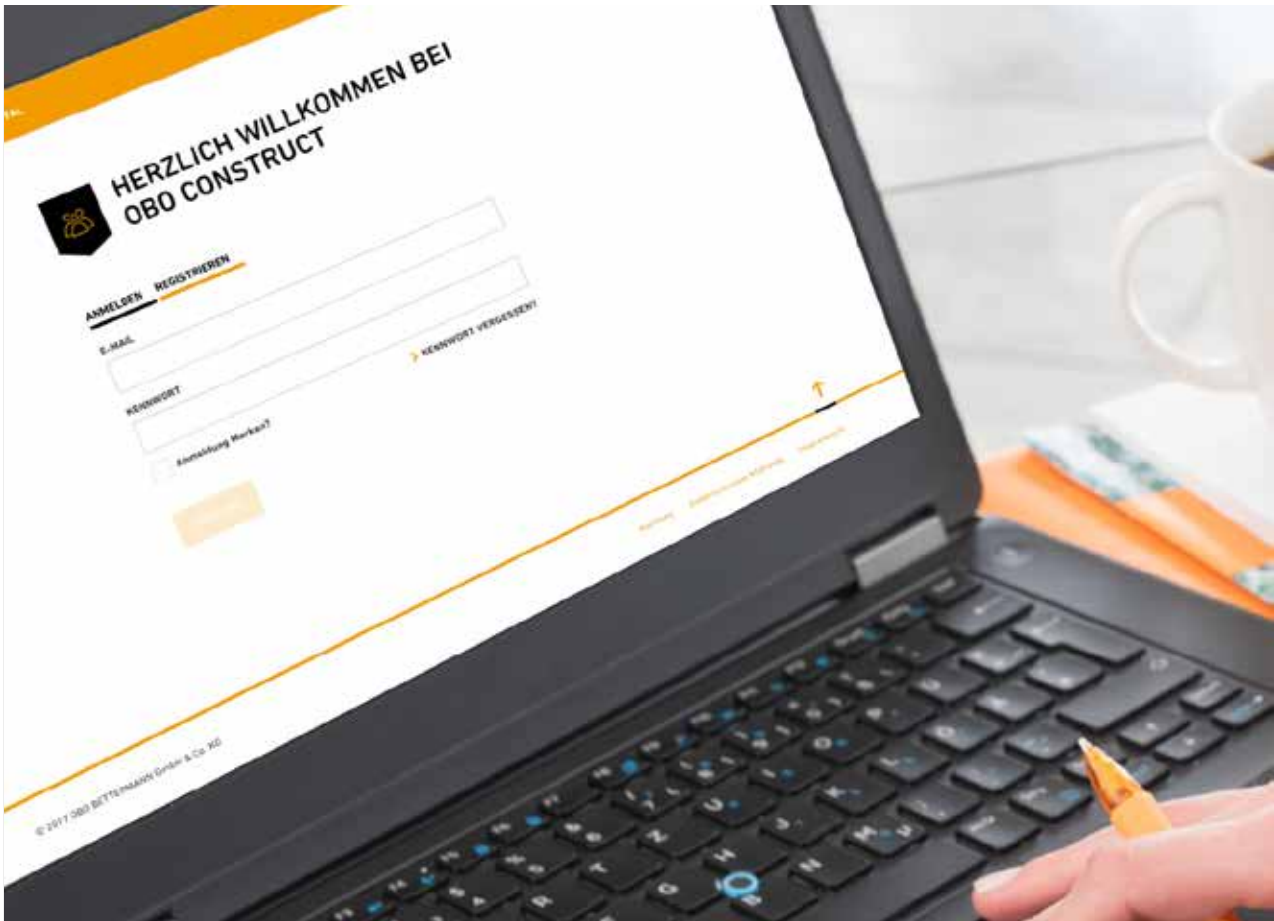

The OBO Construct electronic planning aids are programs developed to support electrical installation engineers and planners in the design of electrical installation systems.

By systemically querying technically relevant planning parameters, these programs simplify the search for suitable products and related system accessories.

All new OBO Construct apps have responsive design. They can be opened on any device, regardless of operating system.

Advantages:

- Work aid independent of time and place
- Transmit planning requirements to complete product systems
- Find suitable products quickly and simply
- Calculate quantities automatically
- Download configuration results as Excel or Word files

Currently available versions:

- **Cable support systems**
AutoCAD plug-in version 3.0
(AutoCAD full version from 2013)
- **Underfloor systems**
Planning tool version 3.0
(web app for all devices)
- **Transient and lightning protection systems**
Earthing systems version 1.0
(web app for all devices)
- **Fire protection systems**
Insulation selection aid version 3.0
(web app for all devices)
- **Transient and lightning protection systems**
Surge protection version 1.0
(web app)
- **Cable support systems**
Cable assignment version 3.0
(web app for all devices)

More information

www.obo-construct.com



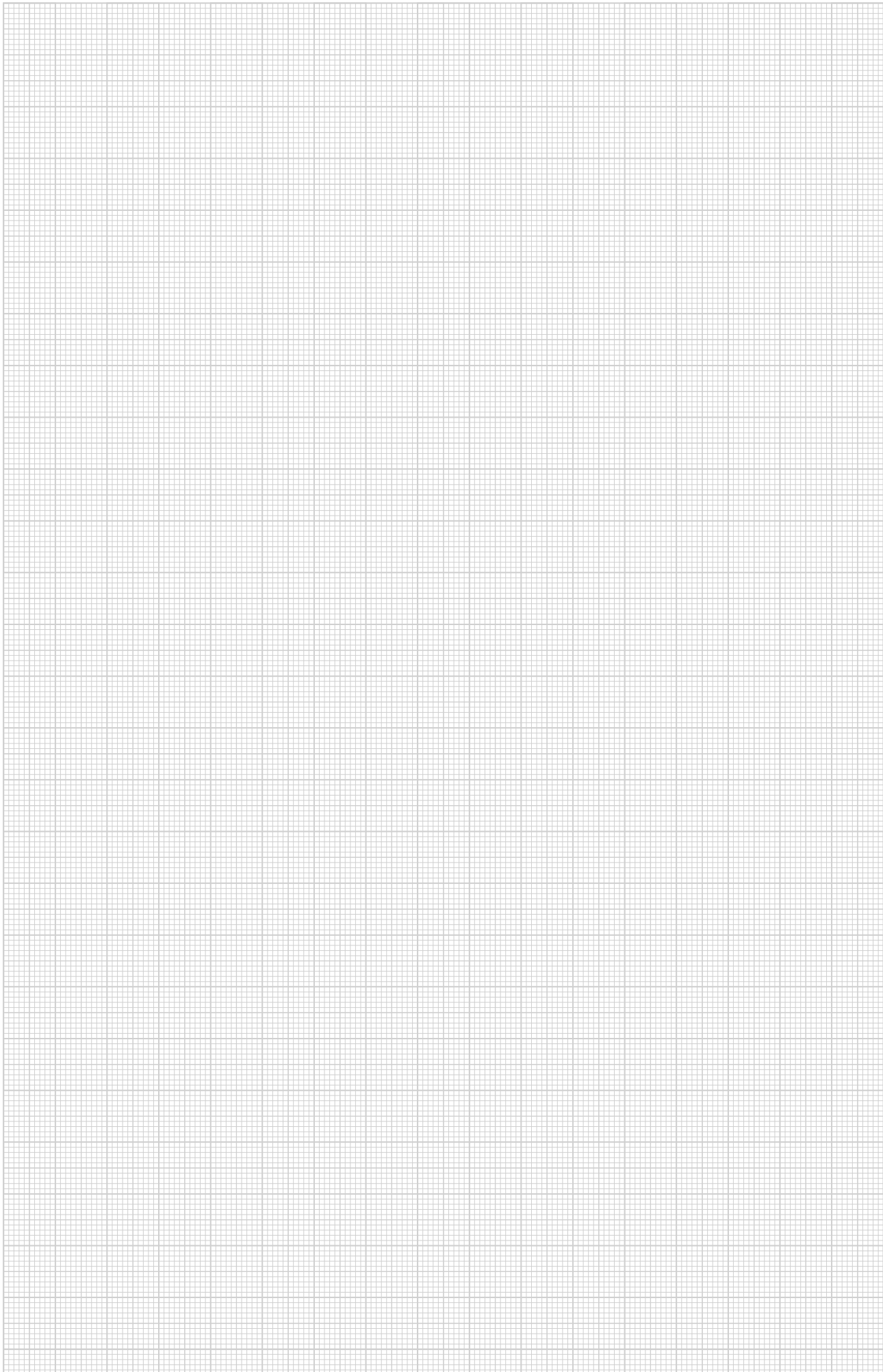

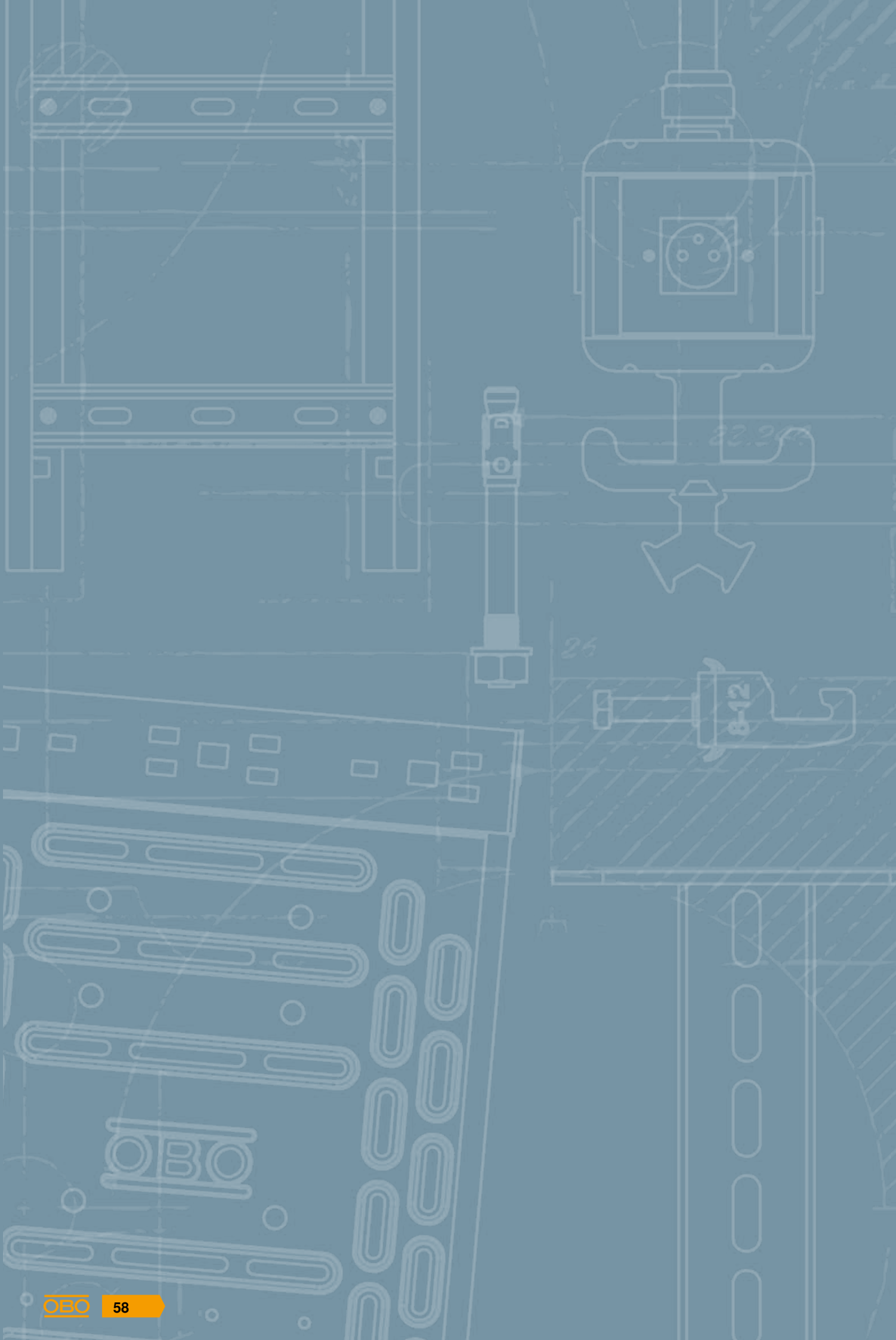

Cable trays



Magic® cable tray system

60



MKS-Magic®, SKS-Magic® cable tray system

66



MKS, SKS, DKS, IKS cable tray system

72



Wide span cable tray system

80



System description



The RKS-Magic® cable tray system permits particularly fast straight connections of cable trays. The innovative, screwless straight connector can be mounted in the blink of an eye. Just connect the ends of the cable tray, lock them in place – and you're done! The long-lasting, static straight connectors can be permanently stabilised by bending the connection flaps. The RKS-Magic® cable tray is available with the side heights 35 and 60 mm. A comprehensive range of fittings with bends (45° and 90°), tees, add-on tees and cross-overs completes the system. 90° bends and adjustable vertical riser (rising/falling) are available for vertical changes of direction. When mounting fittings, always plan additional supports.

Besides the various fittings, the system also includes all types of connectors (straight, angle and adjustable connectors) and additional accessories such as barrier strips, joint plates, mounting plates and lids.

You can find detailed mounting aids and article descriptions for this system on the following pages. The RKS-Magic® cable tray is tested for routing with the maintenance of electrical function. You can find comprehensive information on this in our new Safety and protective installations product catalogue.



Installation principle

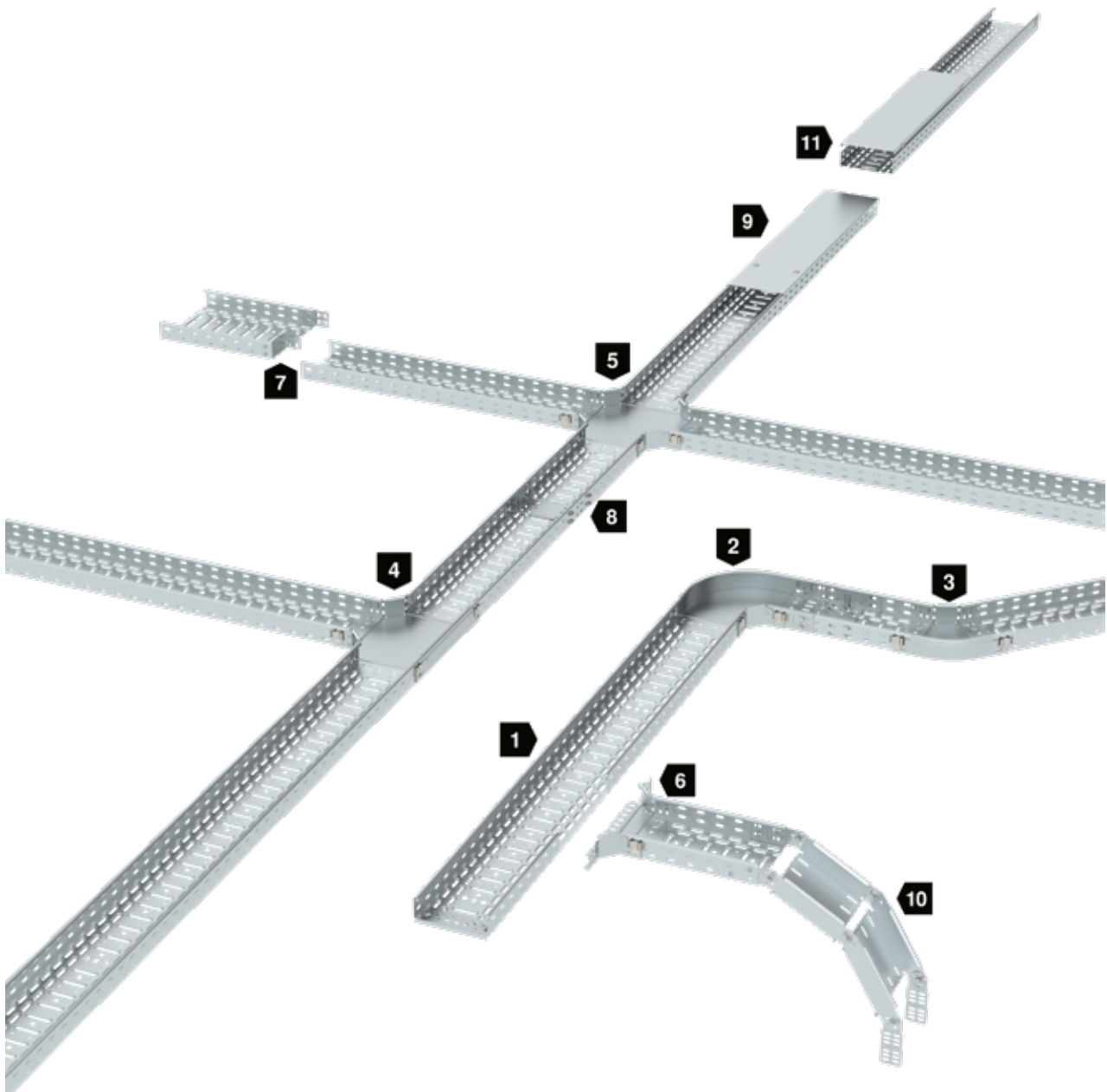

- 1** RKSM cable tray
- 2** 90° Magic bend
- 3** 45° Magic bend
- 4** Magic tee
- 5** Magic horizontal cross-over
- 6** Magic add-on tee
- 7** Reducer/stop-end
- 8** Magic straight connector set
- 9** Cover with turn buckle
- 10** Adjustable bend element
- 11** Unperforated cover and cover clamp

Mounting aid



Centre suspension application

Direct centre suspension with threaded rod, type 2078/M10. This mounting variant is possible for RKS cable trays of width 50 to 200 mm.



Ceiling mounting application, U support with bracket

Standard mounting of a cable tray with suspended support, type US, and suitable support bracket, type AW.



Wall mounting application with bracket

Standard cable tray mounting on the wall with wall and support brackets.



Quick fastening of cable tray on the bracket

The quick fastening is pushed upwards and turned through 90°. After locking, the quick fastening is fastened permanently by tightening it.



Straight cable tray connection, sleeve mounting

The spring element of the cable tray to be connected is snapped into the spring seat of the preceding cable tray from above.



Straight cable tray connection, sleeve mounting

The connected cable trays are fixed in place by bending the connection straps in the base with a screwdriver.



Releasing the connection

The straight connector can be released again at any time. To do this, push a screwdriver under the spring element to release the lock.



Mounting of Magic KTSMV straight connector set

To strengthen the connection, we recommend screwing on the joint plate for widths of more than 400 mm.



Floor fastening

Floor fastening at a distance with stand-off bracket, type DBL.

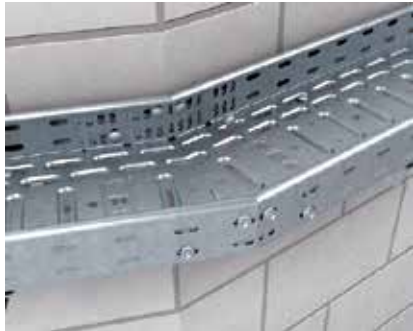

Horizontal angle connection of cable trays

Horizontal angle connection of cable trays for brackets created during construction and cut cable tray ends.



Vertical adjustable connection of cable trays

Vertical adjustable connection of cable trays for construction-side height jumps of any angle.



Width change and end closure

Illustration of a width change through the installation of the reducing bracket. This component allows the implementation of an end closure of cable trays.



Mounting of Magic bend

Mounting of fittings by simple interconnection. For this, the cable tray with the spring side is locked into the fitting connection from above.



Mounting of Magic add-on tee

Mounting of fittings by simple interconnection. For this, the cable tray with the spring side is locked into the fitting connection from above.



Mounting of Magic vertical add-on tee (bottom view)

Vertical mounting of the add-on tee as length-wise funnel. Perforation in the cable tray is created on site. For widths > 400 mm, please order connectors separately.



Mounting of Magic cross-over

Mounting of fittings by simple interconnection. For this, the cable tray with the spring side is locked into the fitting connection from above.



90° bend (rising/falling)

The 90° vertical bend is pushed over the rail of the cable tray and bolted with truss-head bolts, FRSB M6 x 12 mm. The cover is placed on loosely and fastened using the incoming cable tray covers. The cover clamp DKU can be used for additional fastening.



Mounting of rising adjustable vertical bend

Adjustable vertical bend to bridge height offsets or when changing from horizontal to vertical. The vertical adjustable bend is fastened to the cable tray directly using adjustable connectors.



Mounting of falling adjustable vertical bend
Mounting of the vertical adjustable bend, falling, to bridge height differences and changes from the horizontal to the vertical.



Mounting of floor end plate
The floor end plate is fastened to the end of the cable tray. It is used to protect outgoing cables.



Mounting plate with quick fastening
Fastening of the mounting plate, type MP, on the side rail of the cable tray. The mounting plate can be fastened to the rail with quick connectors, and permanently fastened using truss-head bolts of type FRSB 6x12 mm.



Universal mounting plate
The MP UNI mounting plate is attached by screwing it to the side rail of the cable tray.



Cover mounting with turn buckle
The cover is fastened to the cable tray using turn buckles; this is done by clamping the turn buckle under the rolled up side rail of the cable tray with a 90° turn.



Screwless cover mounting
Screwless cover mounting takes place with unperforated covers and the cover clamps, type DK DRLU. The cover clamp is simply fixed in the rail of the cable tray.



Mounting of fitting cover
The fitting cover is fastened to the cable tray using turn buckles; this is done by clamping the turn buckle under the rolled up side rail of the cable tray with a 90° turn.



Screwless barrier strip mounting
Screwless mounting of the TSG ... barrier strip with the KS KR hold-down clamp. The barrier strip can be run over the joint and connected without bolts and without processing using the barrier strip connector TSGV.



Screwless barrier strip mounting
Screwless barrier strip fastening of the barrier strip TSG 60, with truss-head bolts M 6x12. The barrier strip can simply be run over the joint and connected without bolts using the barrier strip connector TSGV.

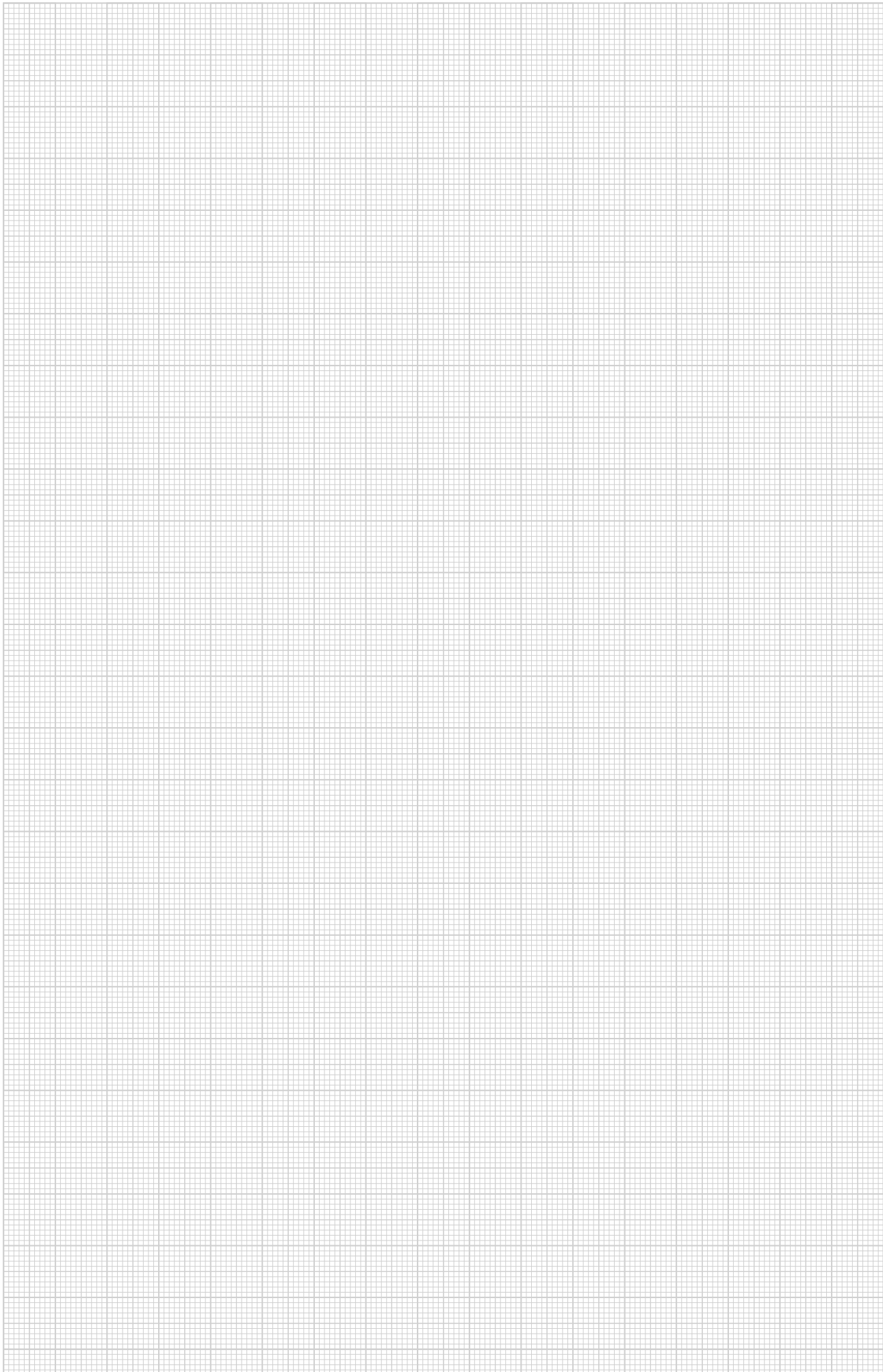

System description



The cable tray is suitable for universal cable routing. From low-voltage cabling to power supplies, from data cables to telecommunications networks. A full product range, with suitable system components, can create perfect solutions for any task. No matter whether used in dry inner areas or in aggressive atmospheres: Different surface versions and materials ensure safe corrosion protection. Side heights of 60, 85 and 110 mm are available. Due to the high hole proportion of 30% and more, the perforated cable trays MKSM and SKSM of widths of 200 mm or greater are ideally suited for use beneath sprinkler systems. The IKSM cable tray also has large openings in the side rail, which can be used for cable entries or exits.

The complete system is supplemented by connectable, screwless fittings with Magic connection. The system also includes all types of connectors and additional accessories such as barrier strips, joint plates, mounting plates and covers.

You can find detailed mounting aids and article descriptions for this system on the following pages.

Installation principle

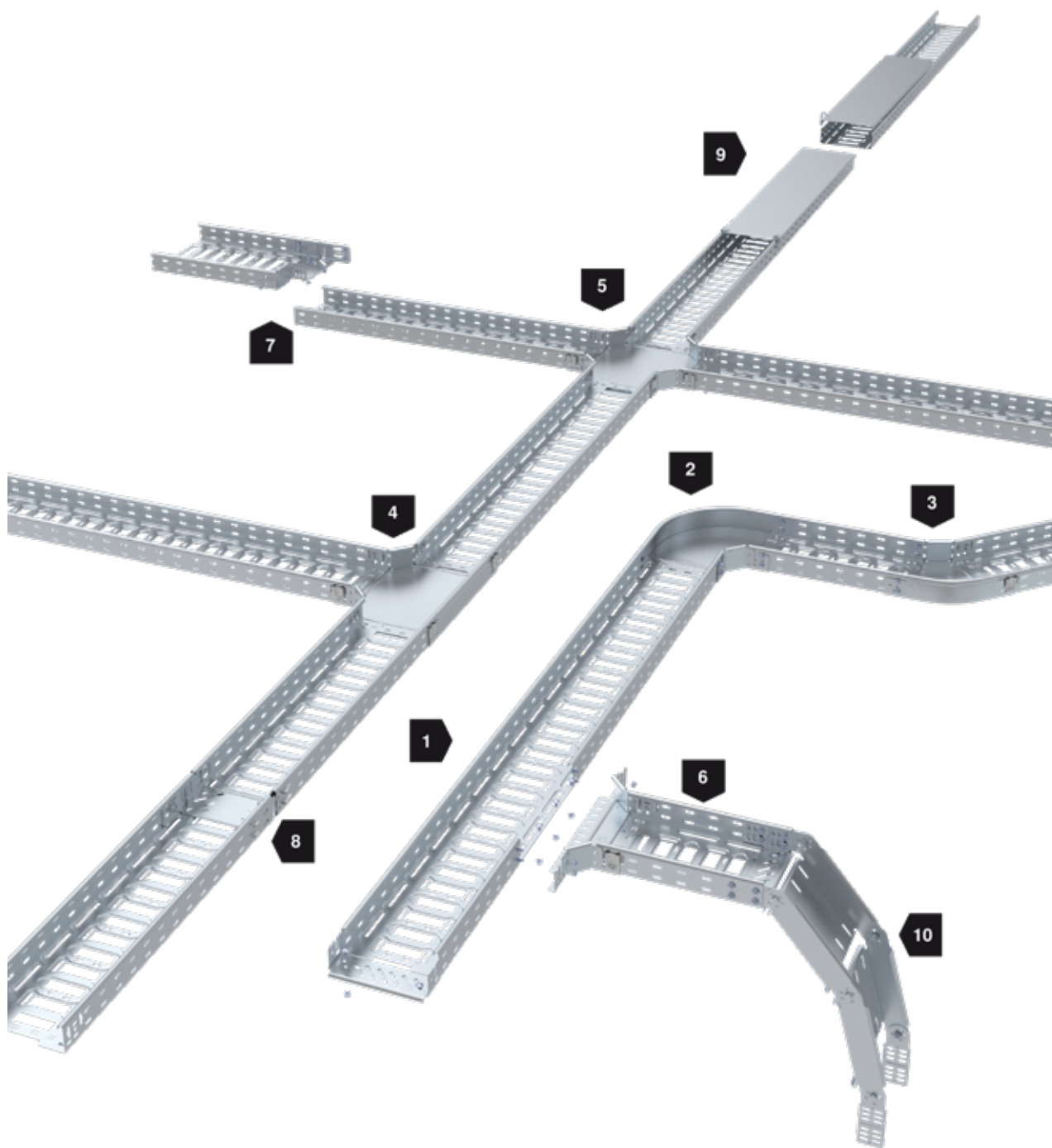

- 1** Cable tray MKSM/SKSM
- 2** 90° Magic bend
- 3** 45° Magic bend
- 4** Magic tee
- 5** Magic horizontal cross-over
- 6** Magic add-on tee
- 7** Reducer/stop-end
- 8** Magic straight connector set
- 9** Cover with turn buckle
- 10** Adjustable bend element

Mounting aid



Centre suspension application

Centre suspension of the cable tray systems MKSM, SKSM and IKSM with a centre suspension type MAH and threaded rod 2078/M10.



Wall mounting application with bracket

Standard mounting of a cable tray on the wall with wall and support brackets.



Mounting of Magic KTSMV straight connector set

Simply clamp the two side sections of the connector set in the side rail.



Mounting of Magic KTSMV straight connector set

Insert the corresponding joint plate, push it down and simply lock it in place. To strengthen the connection, we recommend screwing on the joint plate for widths of more than 400 mm.



Change of direction by cutting the cable tray

Cut and bend the cable tray, then fix the cut rail with an angle connector, type RWVL.



Change of direction with separate cable trays

To create a change of direction with 2 separate cable trays, 2 angle connectors are used for fastening.



Change of direction with separate cable trays

Combine the cut trays and fix them from the inside at the joint using angle connectors, type RWVL.



Creating a change of direction with variable Magic bend

The variable Magic bend, type RBMV..., can be used to install infinitely variable direction changes of 0°–90° to the route.



Vertical adjustable connection of cable trays

Vertical adjustable connection of cable tray for construction-side height jumps of any angle.



Mounting of Magic bend

Mounting of fittings by simple interconnection. For this, the cable tray with the spring side is locked into the fitting connection from above.



Mounting of Magic add-on tee

Mounting of fittings by simple interconnection. For this, the cable tray with the spring side is locked into the fitting connection from above.



Mounting of Magic tee

Mounting of fittings by simple interconnection. For this, the cable tray with the spring side is locked into the fitting connection from above.



Mounting of Magic cross-over

Mounting of fittings by simple interconnection. For this, the cable tray with the spring side is locked into the fitting connection from above.



90° bend (rising/falling)

90° bend, rising or falling, for the creation of simple vertical changes of direction.



Mounting of adjustable vertical bend element

Mounting of the adjustable vertical bend element for the creation of adjustable bends. The adjustable vertical bend element is connected to the cable tray using adjustable connectors.



Mounting of rising adjustable vertical bend

Rising adjustable vertical bend to bridge height offsets. The adjustable vertical bend is connected with to the cable tray using the adjustable connectors.



Screwless cover mounting

Unperforated covers are mounted using cover clamps, type DK DRLU. The cover clamps are first clamped to the cover edge and then snapped on to the cable tray rail with the cover.



Mounting of floor end plate

Fastening of the bottom end plate, type BEB, to protect the cables.



Universal mounting plate

Fastening of the mounting plate, type MP UNI, on the cable tray.

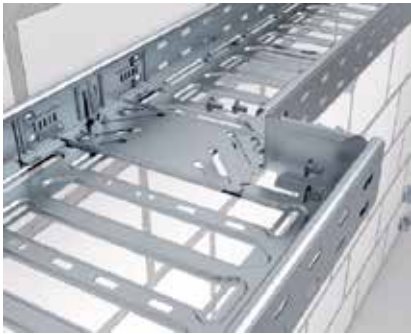

Installation of reducer/stop-end plate

Reducer/stop-end plates are used as closure and to reduce the width of cable trays.



Barrier strip mounting with screw connection

Screwed barrier strip fastening of the barrier strip TSG 60, with truss-head bolts M 6x12. The barrier strip can simply be run over the joint and connected without bolts using the barrier strip connector TSGV.

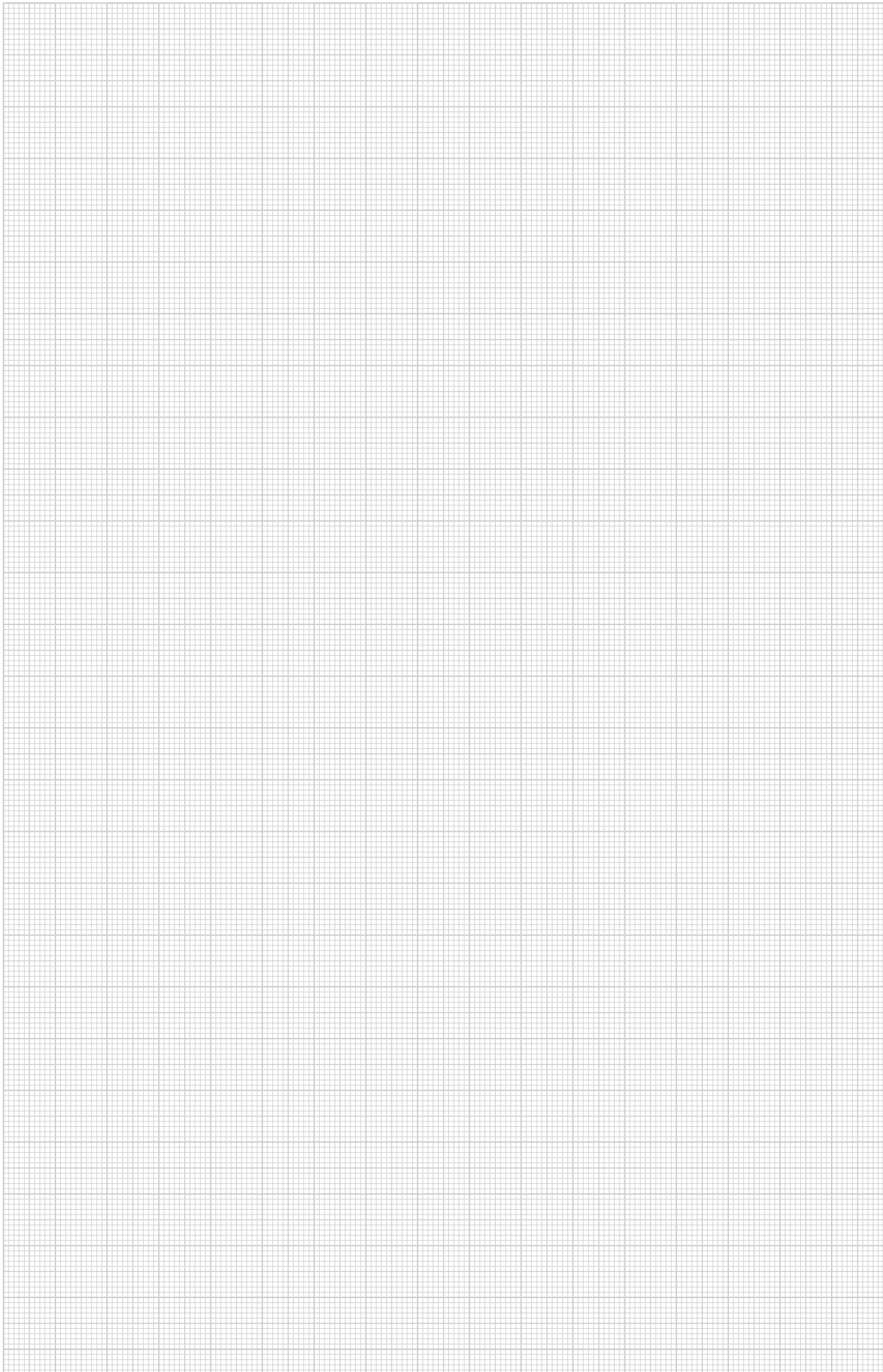

System description

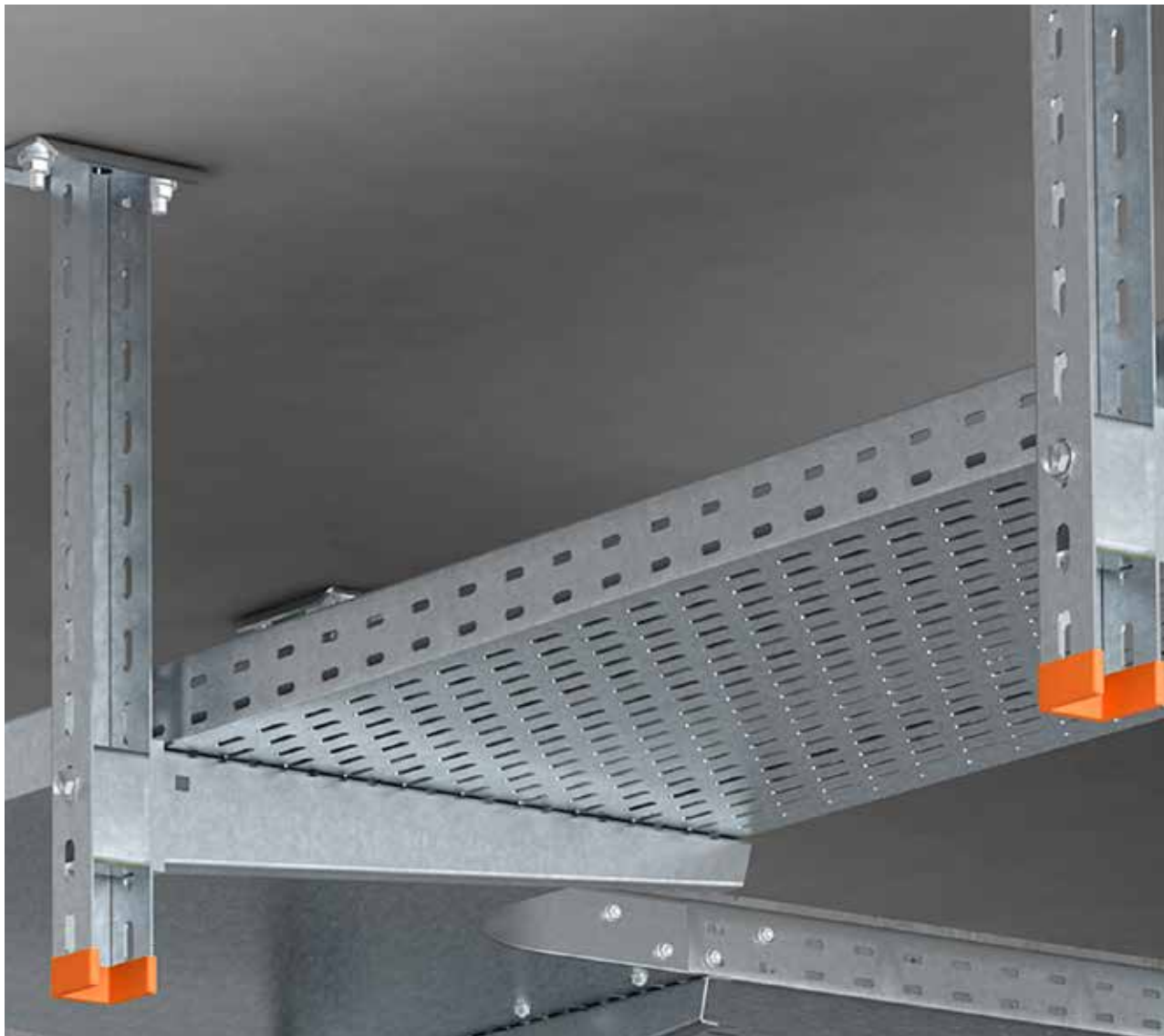

The cable tray is suitable for universal cable routing. From low-voltage cabling to power supplies, from data cables to telecommunications networks. A full product range, with suitable system components, can create perfect solutions for any task. No matter whether used in dry inner areas or in aggressive atmospheres: Different surface versions and materials ensure safe corrosion protection. Side heights of 35, 60, 85 and 110 mm through

to the special cable tray systems DKS and IKS with 30% perforations and large entries and exits are available. When mounting fittings, always plan additional supports. Besides the various fittings, the system also includes all types of connectors and additional accessories such as barrier strips, joint plates, mounting plates and covers. You can find detailed mounting aids and article descriptions for this system on the following pages.



Installation principle MKS/SKS cable tray system

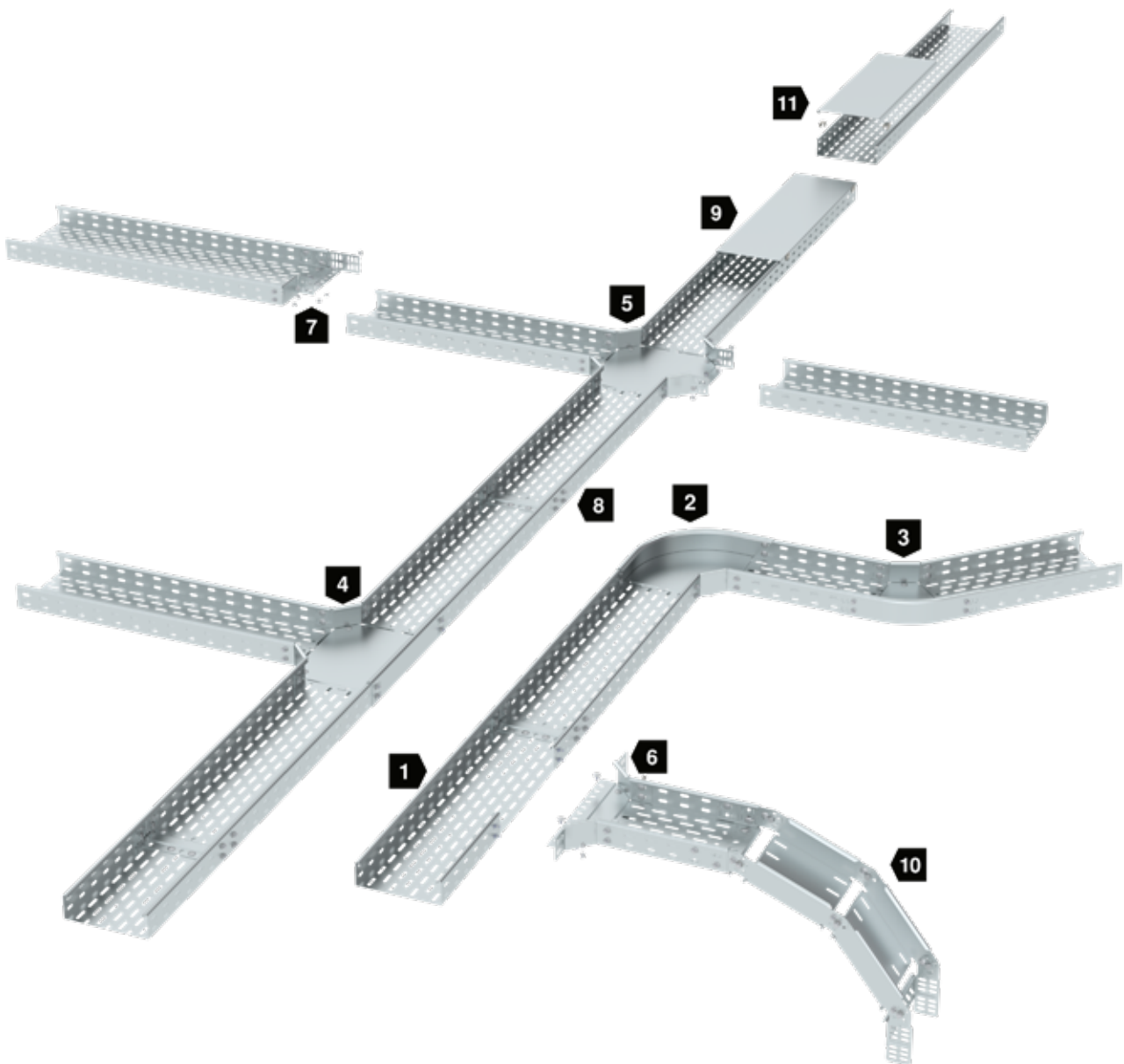

- 1** Cable tray MKS/SKS
- 2** 90° bend
- 3** 45° bend
- 4** Horizontal tee
- 5** Cross-over
- 6** Add-on tee
- 7** Reducer/stop-end
- 8** Straight connector set
- 9** Cover with turn buckle
- 10** Adjustable bend element
- 11** Unperforated cover and cover clamp

Installation principle DKS cable tray system

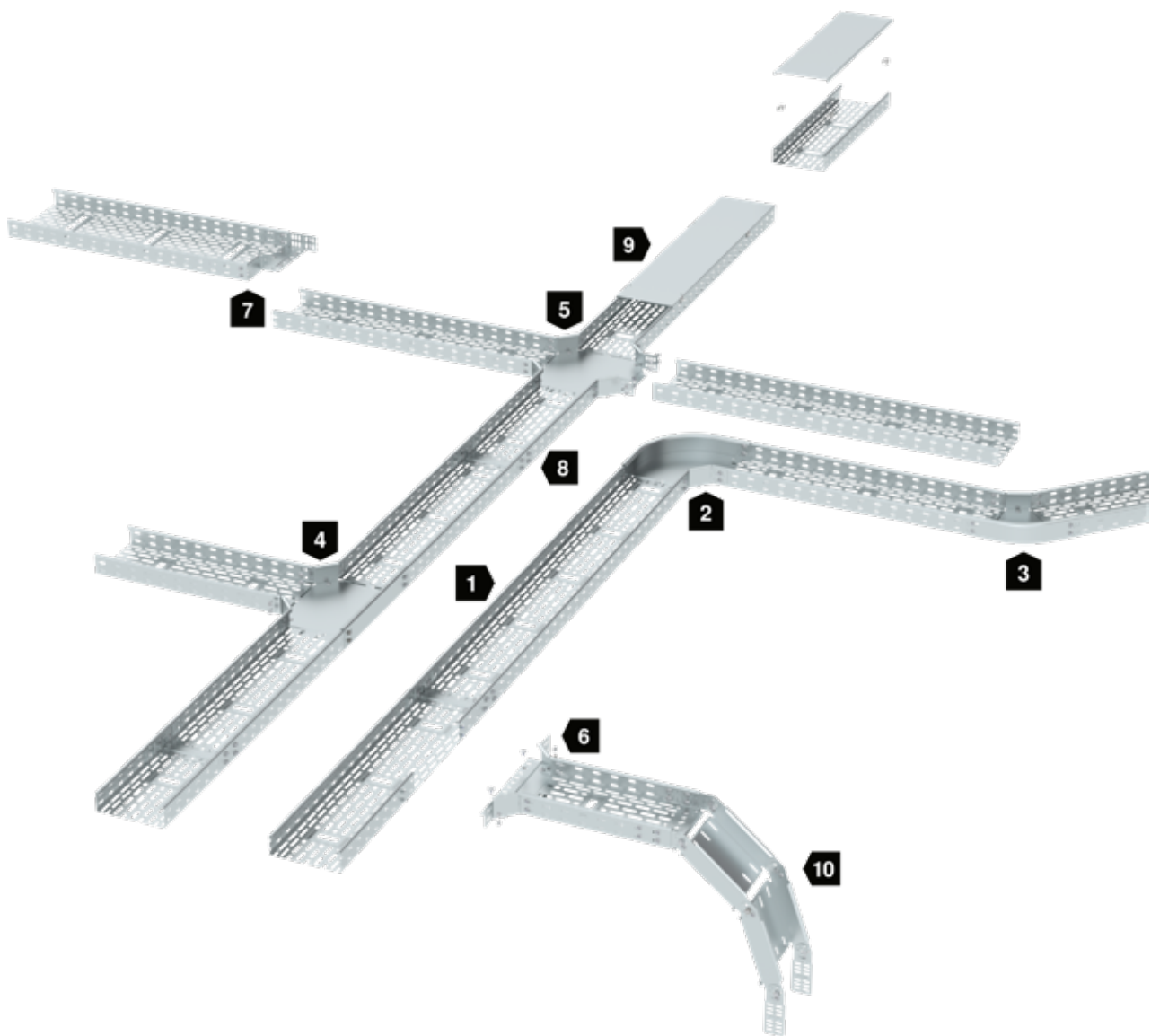

- 1 Cable tray DKS
- 2 90° bend
- 3 45° bend
- 4 Horizontal tee
- 5 Cross-over
- 6 Add-on tee
- 7 Reducer/stop-end
- 8 Straight connectors and joint plate
- 9 Unperforated cover and cover clamp
- 10 Adjustable bend element



Installation principle IKS cable tray system

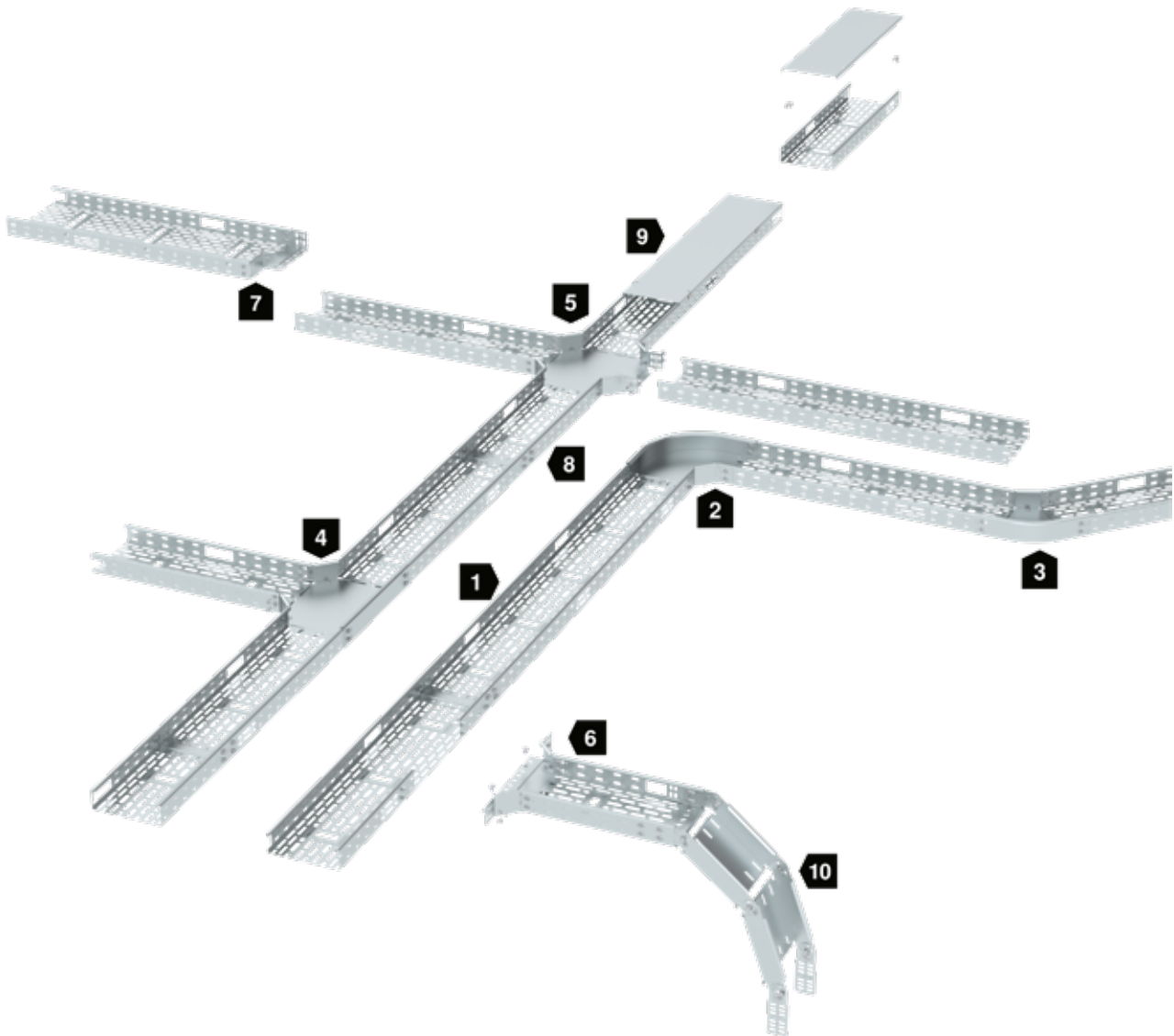

- 1** Cable tray IKS
- 2** 90° bend
- 3** 45° bend
- 4** Horizontal tee
- 5** Cross-over
- 6** Add-on tee
- 7** Reducer/stop-end
- 8** Straight connectors and joint plate
- 9** Unperforated cover and cover clamp
- 10** Adjustable bend element

Mounting aid



Centre suspension application

Centre suspension of the cable tray systems MKS, SKS, EKS, DKS and IKS with centre suspension, type MAH, and threaded rod 2078/ M10.



Ceiling mounting application

Ceiling mounting of a cable tray with suspended support and wall and support bracket.



Wall mounting application with bracket

Standard mounting of a cable tray on the wall with wall and support brackets.



Installation of RV straight connector set

Straight connection of the cable trays through simply clamping the connector set RV into the side rail.



Screwless RV longitudinal connector set

Press the corresponding joint plate downwards and snap it in place.



Straight connection with joint cover

Cable tray with screwed straight connection and joint plate, type SSLB. The joint plate can also be mounted above the bar of the RV straight connector set.

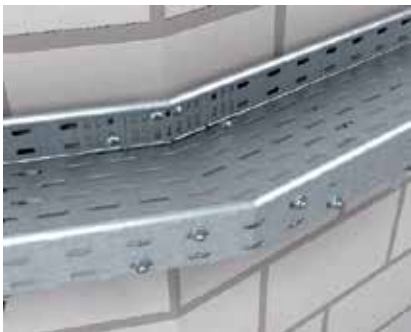

Horizontal angle connection of cable trays

Horizontal angle connection of cable trays for brackets created during construction and cut cable tray ends.



Vertical adjustable connection of cable trays

Vertical adjustable connection of cable trays for construction-side height jumps of any angle.



Bend creation with corner connector

For 90° bends to be created on-site, the corner connector, type REV, can be used to increase the internal radius.



Direct connection with corner connectors

Corner connector, type REV, to increase the angle when creating tees without fittings. Additional supports should be planned for the area of the branches.



Branch with angle connectors

Installation of built T exit with angle connectors, type WKV. Additional supports should be planned for the area of the branches.



Installation of reducer/stop-end plate

The reducer/stop-end plate component is used as closure and to reduce the width of cable trays.

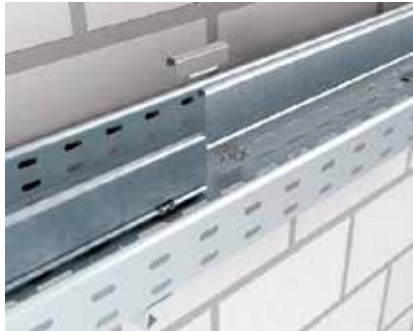

Screwless barrier strip mounting

Screwless mounting of the TSG ... barrier strip with the KS KR hold-down clamp. The barrier strip can be run over the joint and connected without bolts and without processing using the barrier strip connector TSGV.

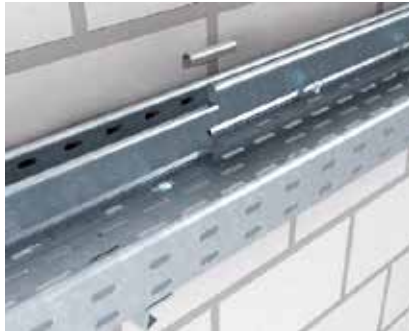

Barrier strip mounting with bolt connection

Screwed barrier strip fastening of the barrier strip TSG 60 with truss-head bolts M6x12. The barrier strip can simply be run over the joint and connected without bolts using the barrier strip connector TSGV.



Installation of bend (width 400–600 mm)

The bend in widths 400 to 600 mm is connected to the cable tray using connectors and a joint plate. Additional supports should be planned for the area of the fittings.



Installation of add-on tee (width 100–300 mm)

To mount the add-on tee, separate the cable tray rail and screw it tight. Additional supports should be planned for the area of the fittings.



Installation of add-on tee (width 400–600 mm)

To mount the add-on tee, separate the cable tray rail and screw it tight. Additional supports should be planned for the area of the fittings.



Installation of vertical add-on tee

Vertical mounting of the add-on tee as length-wise funnel.



Installation of vertical add-on tee

Vertical mounting of the add-on tee as length-wise funnel.



Mounting of tee

The tee is connected to the cable tray using connectors and a joint plate. Additional supports should be planned for the area of the fittings.

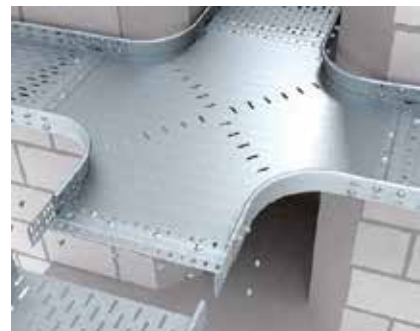

Cross-over mounting

The cross-over is connected to the cable tray using connectors and a joint plate. Additional supports should be planned for the area of the fittings.



90° bend (rising/falling)

90° bend, rising or falling, for the creation of simple vertical changes of direction.



Mounting of adjustable vertical bend element

Mounting of the adjustable vertical bend element for the creation of adjustable bends. The adjustable vertical bend element is connected to the cable tray using adjustable connectors.



Mounting of falling adjustable vertical bend

Falling adjustable vertical bend to bridge height offsets. The adjustable vertical bend is connected with to the cable tray using the adjustable connectors.



Mounting of rising adjustable vertical bend

Rising adjustable vertical bend to bridge height offsets. The adjustable vertical bend is connected with to the cable tray using the adjustable connectors.



Screwless cover mounting

Unperforated covers are mounted using cover clamps, type DK DRLU. The cover clamps are first clamped to the cover edge and then snapped on to the cable tray rail with the cover.



Mounting of floor end plate

Fastening of the bottom end plate, type BEB, to protect the cables.



Mounting plate with quick fastening

Fastening of the mounting plate, type MP, on the cable tray. The mounting plate can be fastened to the rail with quick connectors, and permanently fastened using truss-head bolts of type FRS B.



Universal mounting plate

Fastening of the mounting plate, type MP UNI, on the cable tray.

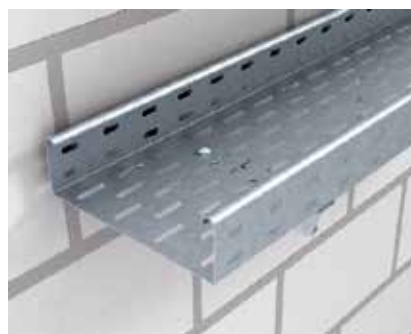

Fastening on bracket

The cable tray is fastened to the bracket with truss-head bolts FRS M6 x 12.



Cable tray mounting on steel girders

Cable tray mounting with chuck jaws of type TKS-L25 and U supports as cantilever beams on steel girders. Use spacers, type DSK, for safe functioning.



Creating a height increase or decrease

After cutting into the side rail, the cable tray is bent manually at an angle of 0–60° and fixed with the straight connector RLVKV 60 FS. It is not necessary to cut into the bottom plate.



System description



When you need to bridge wide spans and support high cable loads, the OBO wide span cable trays are the perfect solution. The product range comprises cable trays with widths of between 200 and 600 mm and side heights of 110 to 200 mm. Comprehensive system accessories such as fittings and all the fastening materials for concrete and steel mounting round off this product range perfectly. OBO wide span cable trays have proven

their worth in many areas of industrial and systems engineering. These systems are becoming ever-more popular in buildings with steel framework. OBO wide span cable trays are the complete product range for all applications and requirements. Their large load capacity combined with large spans allows efficient and optimised power supply.

Installation principle

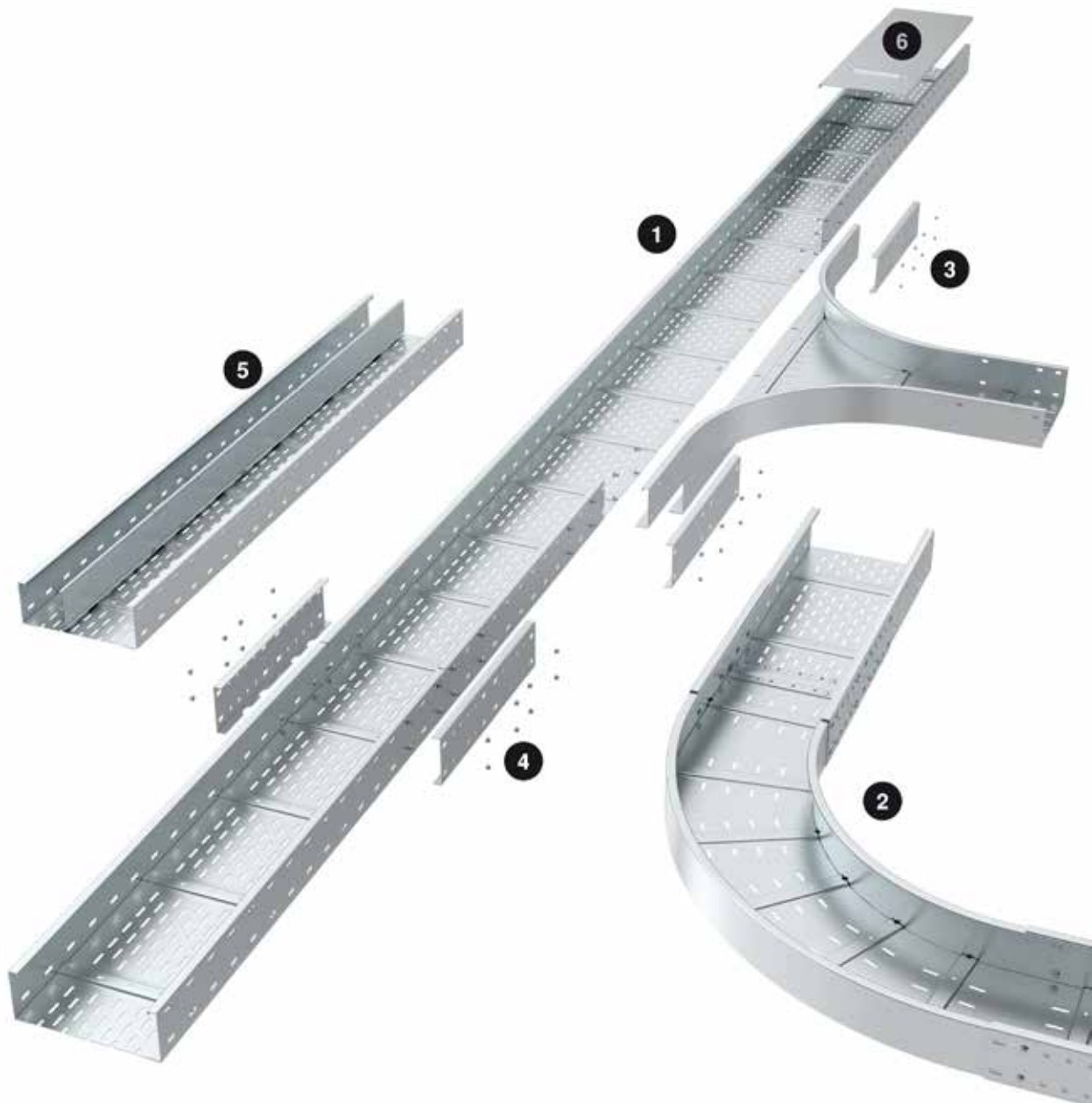

- 1 Wide span cable tray
- 2 90° bend
- 3 Add-on tee
- 4 Straight connector
- 5 Barrier strip
- 6 Cover with turn buckle



Mounting aid



Wall mounting application

Direct wall mounting of wide span cable trays.



Wide span straight connection

Horizontal straight connection of wide span cable trays with straight connector set, type WRVL.



Mounting of 90° bend

Bend in combination with wide span cable trays. The bend is connected to the wide span cable tray using external connectors and a joint plate.



Creation of a tee with an add-on corner

Removal of the side rails from the wide span cable tray.



Creation of a tee with an add-on corner

Mounting of the second add-on corner, type WEAS 110.



Creation of a tee with an add-on corner

Removal of the side rail from the ongoing wide span cable tray.



Creation of a tee with an add-on corner

Mounting of the finished branch to the ongoing wide span cable tray.



Mounting of an add-on tee

Add-on tee in combination with wide span cable tray. The side rail is removed for mounting.



Mounting example

Double-sided suspended support mounting made of U profiles with transverse traverse. Fastening of a wide span cable tray, type WKSG 110, with truss-head bolts on the transverse profile.

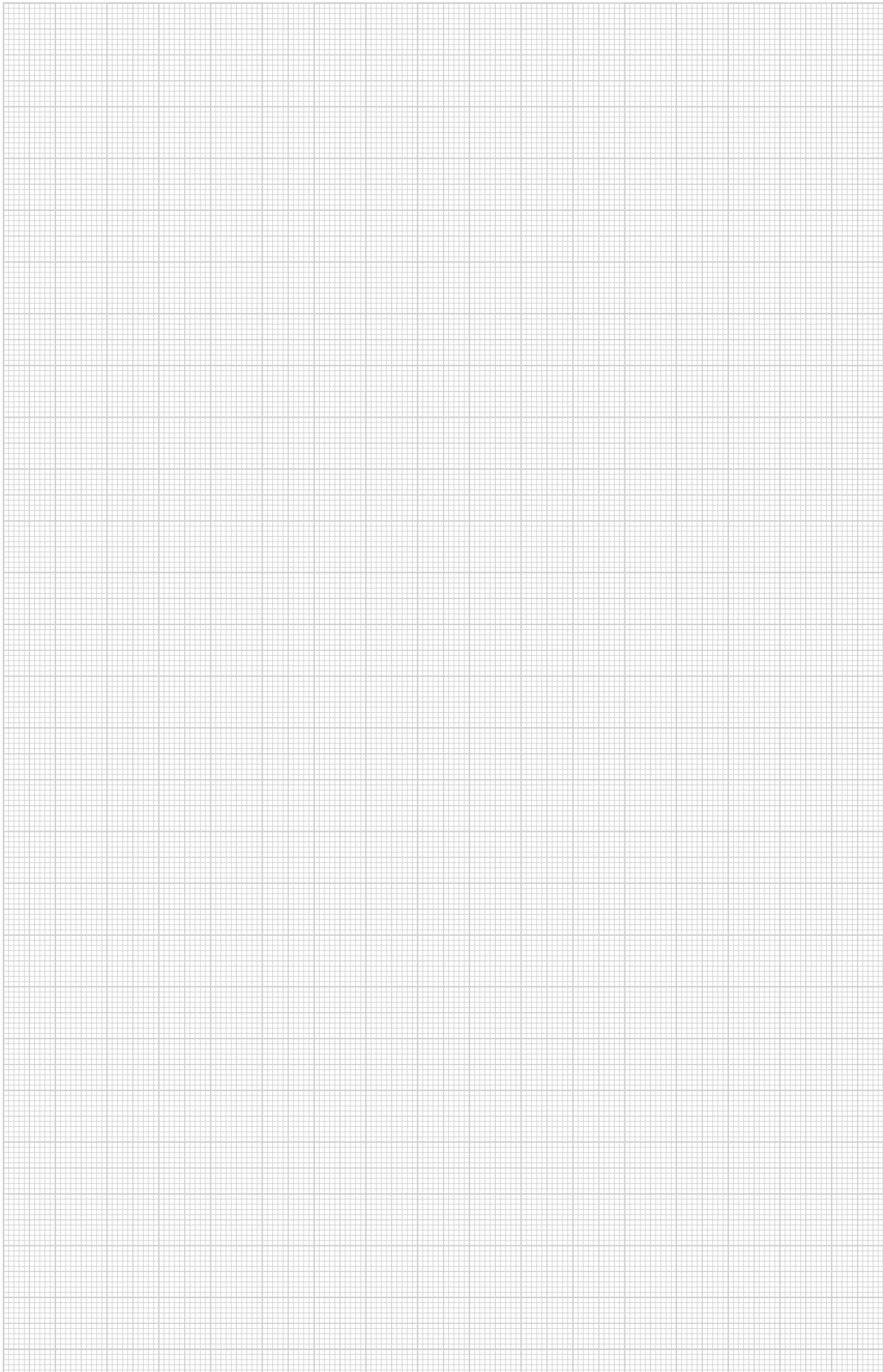

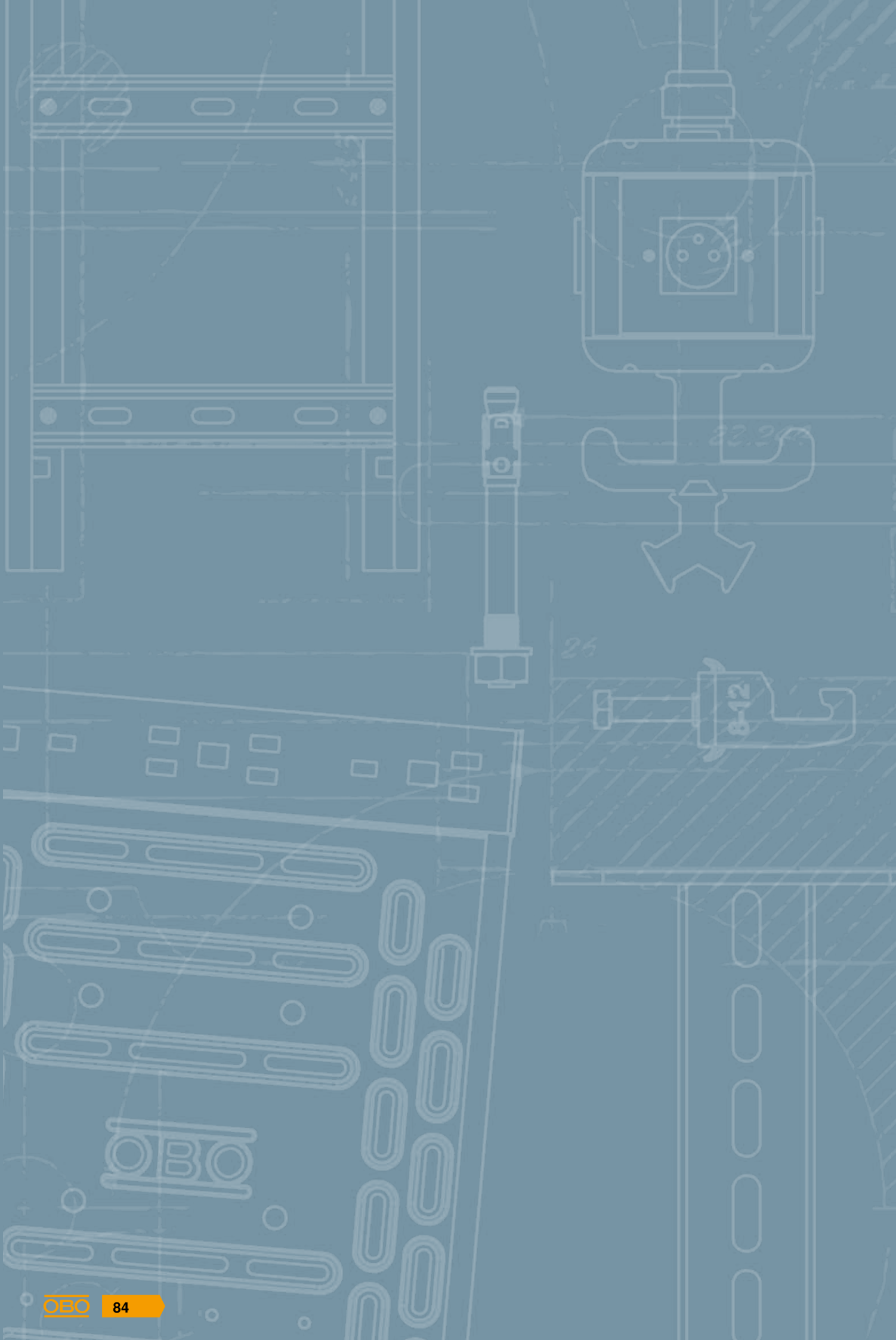

Mesh cable trays



GR-Magic® mesh cable tray system

86



Magic® G mesh cable tray

92



C mesh cable tray

94

System description



OBO Bettermann's mesh cable tray systems are the ideal basis for quick, safe and economical cable routing in all areas of professional electrical installations. The GR-Magic mesh cable tray system with shaped connector for screwless quick mounting guarantees the shortest possible installation times, even for complex mounting operations. The mesh cable trays are available with side

heights of 35, 55 and 105 mm in the electro-galvanised, hot-dip galvanised and stainless steel versions. The comprehensive range of practical accessories, such as mesh cable tray bends, hold-down clamps, quick connectors, barrier strips, suspension profiles, brackets, etc. ensures that the product range is complete down to the smallest detail.

Installation principle

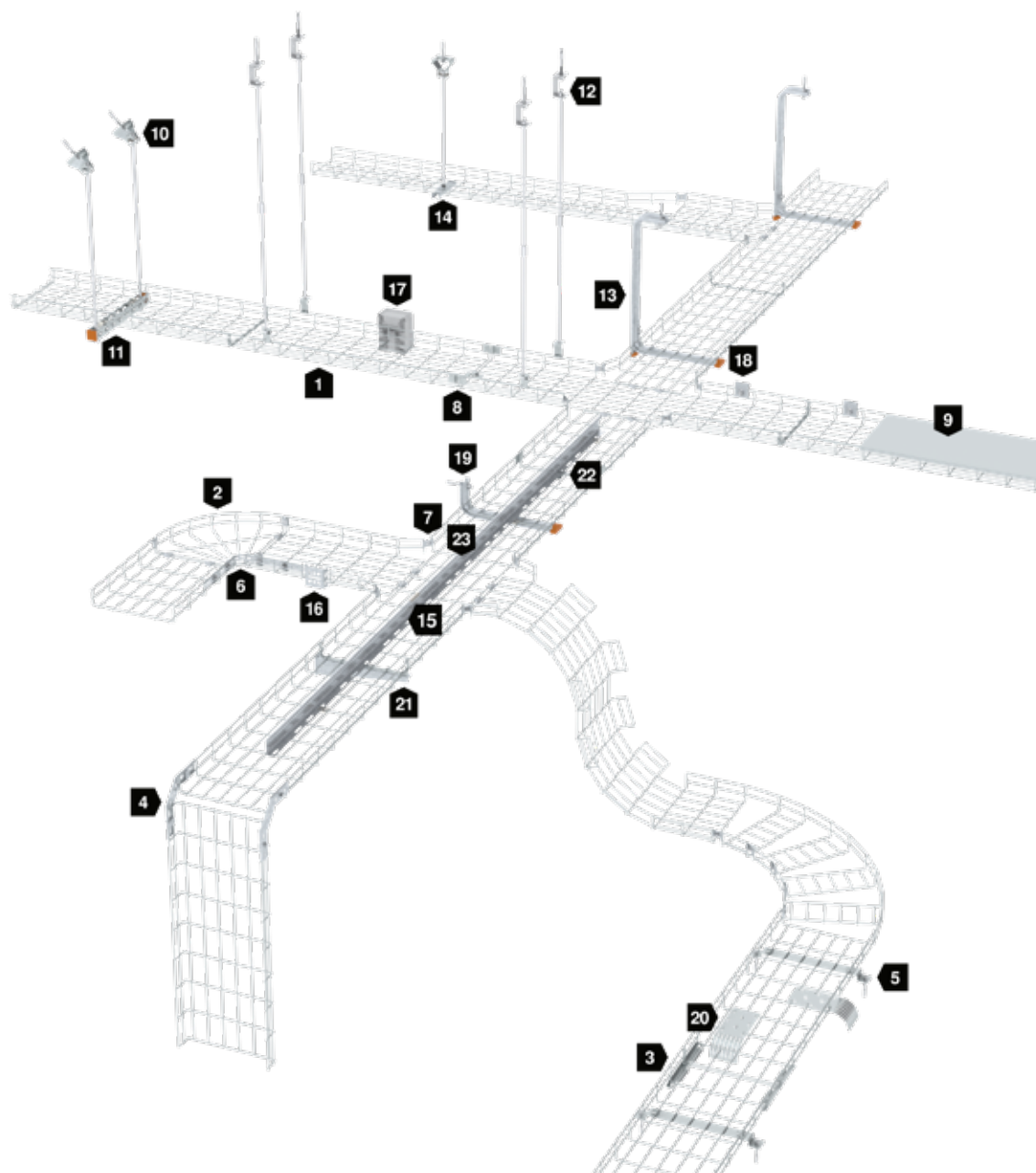

- | | |
|--|---|
| 1 Mesh cable tray GR-Magic | 13 TP suspended support |
| 2 90° mesh cable tray bend | 14 Central suspension, GMS |
| 3 Mesh cable tray connector, long | 15 Barrier strip |
| 4 90° mounting bracket | 16 Mounting plate |
| 5 Stand-off bracket | 17 Fastening element for junction box |
| 6 Slotted steel strap, bent | 18 Wall and ceiling bracket |
| 7 Corner connector | 19 Wall and support bracket TPSAG |
| 8 Joint connector | 20 Cable exit plate |
| 9 Cover, unperforated | 21 Wall and support bracket AWG 15 |
| 10 Cover clamp, variable | 22 Hold-down clamp for barrier strip fastening |
| 11 Mounting rail, MS 41 | 23 Barrier strip connector |
| 12 Ceiling bracket | |

Mounting aid



Ceiling mounting application

Mounting of mesh cable trays with suspended support, type US 3 K/... and appropriate wall and support bracket AW 15/...



Wall mounting GRM 35 50

Wall mounting for direct wall fastening of mesh cable trays GRM 35 50.



Wall fastening of mesh cable trays

Wall fastening of mesh cable trays with wall bracket, type K 12 1818. Maximum mesh cable tray width 200 mm.



Wall and floor fastener WB GR

Fastening component for direct mounting of mesh cable trays to the wall and floor. Can be screwed or riveted on. Suitable for wire thickness 3.9 mm.



Ceiling mounting with TP wall and ceiling bracket

Ceiling mounting of a mesh cable tray with TP wall and ceiling bracket, type TPDG. The mesh cable tray is fastened to the ceiling clamp without screws.



Straight connection of Magic® mesh cable tray

Creation of a screwless straight connection of the mesh cable tray, type GR-Magic®, by interconnecting two stock lengths.



Screwed straight connection of mesh cable trays

Creation of a screwed straight connection of mesh cable trays with joint connectors, type GSV 34.



Screwless straight connection with quick connectors

Creation of a screwless straight connection of mesh cable trays using a quick connector, type GRV.



Screwless straight connection of mesh cable trays

Creation of a screwless straight connection of mesh cable trays with joint connectors, type GRS.



Screwless barrier strip fastening

Screwless fastening of a barrier strip in mesh cable trays with hold-down clamp, type KS GR. The screwless straight connection of the barrier strip is made using the barrier strip connector TSGV.



Screwed-on barrier strip fastening in mesh cable trays

Fastening a barrier strip in mesh cable trays with hold-down clamp, type GKT 38.

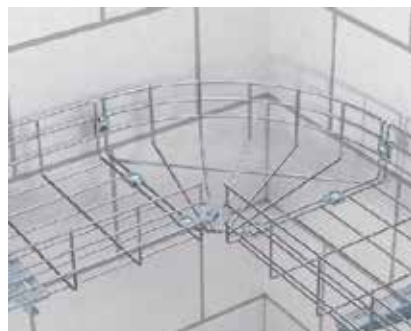

Installation of a mesh cable tray bend

Mounting of a mesh cable tray bend, type GRB 90, with joint connectors, type GSV 34, and corner connector, type GEV 36.



Installation of a mesh cable tray bend

Installation of a complete mesh cable tray bend using joint connectors, type GSV 34, and bent slotted steel strap.



Stand-off of mesh cable trays

Floor stand-off of mesh cable trays with the stand-off bracket, type DBLG 20/... Screwless fastening of the mesh cable tray on the stand-off bracket using clamping lugs.

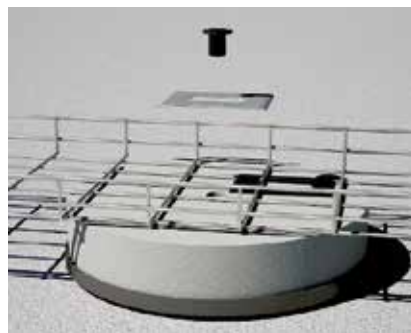

Mounting adapter for mesh cable trays on stand systems

Mounting system TrayFix for fastening mesh cable trays on FangFix blocks (10 or 16 kg) for cable routing on flat roofs.



Direct floor fastening

Direct floor mounting of mesh cable trays using hold-down clamp, type GKS 50.



Fastening clip on MS profile rail

Screwless, rapid fastening of mesh cable trays on MS profile rails with the help of the fastening clip, type BC SGR 4.8 VA for wire thicknesses of 3.9 and 4.8 mm or BC GR 6.0 VA for wire thickness of 6 mm.



Centre suspension

Suspension of a mesh cable tray using threaded rod, type 2078, and wall and floor fastener, type K12 1818. For use with widths of up to 200 mm.



Pendulum suspension

Suspension of a mesh cable tray using threaded rod, type 2078, and wall and floor fastener, type K12 1818. For use with widths of 300 mm or more.



Centre suspension with hanger

Centre suspension of a mesh cable tray with hanger, type GMS, and clamp, type GKS 50.



Suspension with side holder

Suspension of a mesh cable tray with side holders, type SH M 10 and threaded rods, type 2078/M10.



Side holder

Mounting of the side holder, type SH KAB, for accepting cable glands.



Mounting plate

Screwless quick fastening of the mounting plate, type MP UNI.



Identification plate

Mounting of the identification plate, type KS-GR, in the side rail of the mesh cable tray.



Cover mounting

Cover with snap-on function for easy locking to the mesh cable tray.



Girder clamping application

Vertical mesh cable tray mounting, fixed with fixing clamp, type BFK, and hold-down clamp, type GKS 50, to steel girder.



Mounting of mesh angle

Fastening of the mesh angle, type GW 40/80, to steel girders using beam clamps, type KL 20 or KL 30.



Creation of a mesh cable tray bend – angular, overlapping

After the mesh cable trays have been cut to size, they can, together with joint connectors, type GSV 34, and a bent slotted steel strap, be installed overlapping to form an angular mesh cable tray bend.



Creation of a mesh cable tray bend – angular

After the mesh cable trays have been cut to size, they can, together with joint connectors, type GSV 34, and a bent slotted steel strap, be installed as a non-overlapping, angular mesh cable tray bend.



Creation of a mesh cable tray bend – round, overlapping

After the mesh cable trays have been cut to size, they can, together with joint connectors, type GSV 34, and a bent slotted steel strap, be installed overlapping to form a round mesh cable tray bend.



Creation of a mesh cable tray bend – round

Cutting out every second grid of a mesh cable tray allows the creation of mesh cable tray bends with a larger radius. Fixing takes place using corner connectors, type GEV 36.



Rising and falling bends

Rising and falling vertical bends can be created by cutting every second grid in the mesh cable tray edge and bending the mesh cable tray accordingly.



Creation of a mesh cable tray tee

After cutting the side rails and bending the straps, the corner connector, type GEV 36, and the joint connector, type GSV 34, can be used to create tees.



Creation of a mesh cable tray cross-over

After cutting the side rails and bending the straps, the corner connector, type GEV 36, and the joint connector, type GSV 34, can be used to create cross-overs.



Creation of a vertical exit

After cutting the mesh cable tray base, the vertically branching, cut mesh cable tray can be fixed using the joint connector, type GSV 34.



Creation of a reduction

Reductions are possible by single-sided cutting of the different mesh cable tray widths, bending the flaps in the required direction and using the corner connectors, type GEV 36, and the joint connector, type GSV 34.



Mesh cable tray with cable exit plate

Cable exit plate for screwless mounting in mesh cable trays. The cable exit plate allows maintenance of pre-specified bend radii.



Mesh cable tray with cable exit plate

The cable exit plate can be installed in lengthwise and transverse directions.

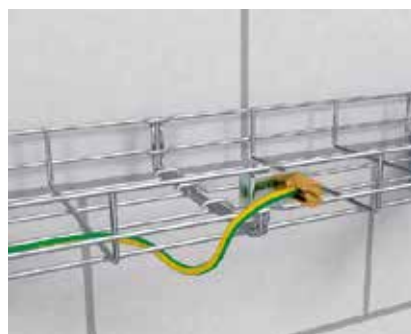

Earthing terminal/earth connection

Earthing terminal for fastening the equipotential bonding wire to the cable support system.

System description

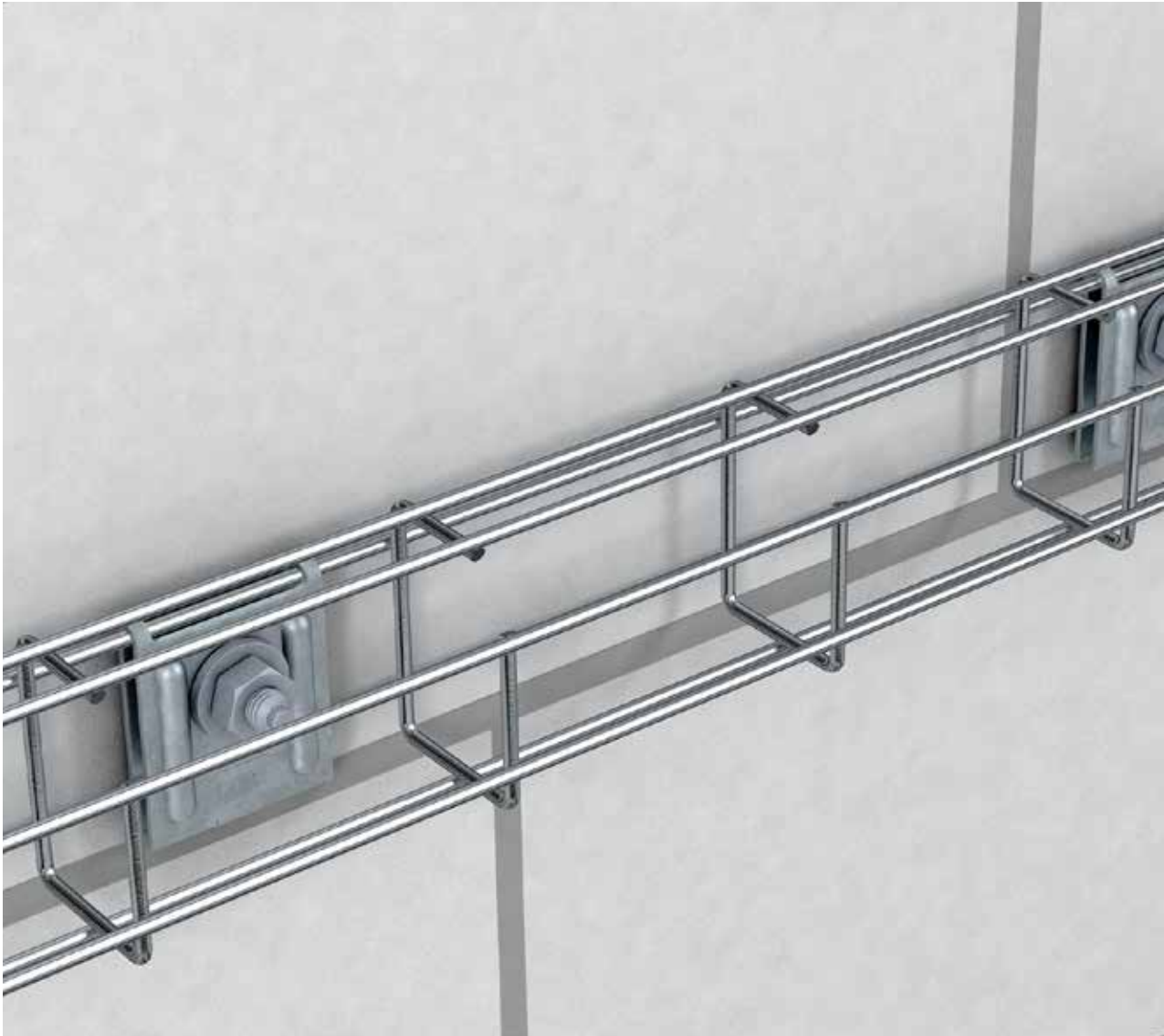

The Magic G mesh cable tray is the ideal extension of the Magic solutions for the OBO Bettermann mesh cable tray systems. The quick Magic connection means that a screwless and easy-to-mount variant is now also offered for the G mesh cable tray system. Even when mounting

in false ceilings, it is an ideal alternative through direct wall or ceiling mounting. The Magic G mesh cable tray is available in four sizes and three surfaces, thus offering ideal solutions for all kinds of tasks.

Mounting aid

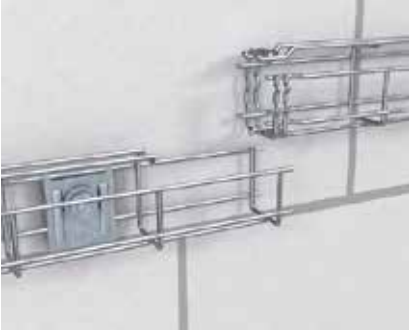

Straight connection of Magic G mesh cable tray

Creation of a screwless straight connection of the G mesh cable tray, type G-GRM, by interconnecting two stock lengths.



Direct ceiling mounting

Direct ceiling mounting of the Magic G mesh cable tray using the hold-down clamp, type K 12 1818.



Wall fastening of G mesh cable trays

Wall fastening of G mesh cable trays with wall bracket, type K 12 1818.

System description



The C mesh cable tray system from OBO Bettermann fulfils the highest requirements for load capacities and versatility. The C shape allows support widths of up to three metres. This system, with its 50 mm side height, together with the optimised accessories such as hold-

down clamps, Quick connectors, barrier strips, suspension profiles, mounting brackets, etc. is an ideal addition to the overall mesh cable tray system. It is used both in industry and in all other areas of professional electrical installations.

Mounting aid



Straight connection of C mesh cable tray
Creation of a straight connection on C mesh cable trays with the joint connector, type GSV 34.



Horizontal bends
Implementation of a horizontal bend for C mesh cable trays with corner connector, type GEV 36.



Vertical bend
Vertical bend mounting with 90° mounting angle.

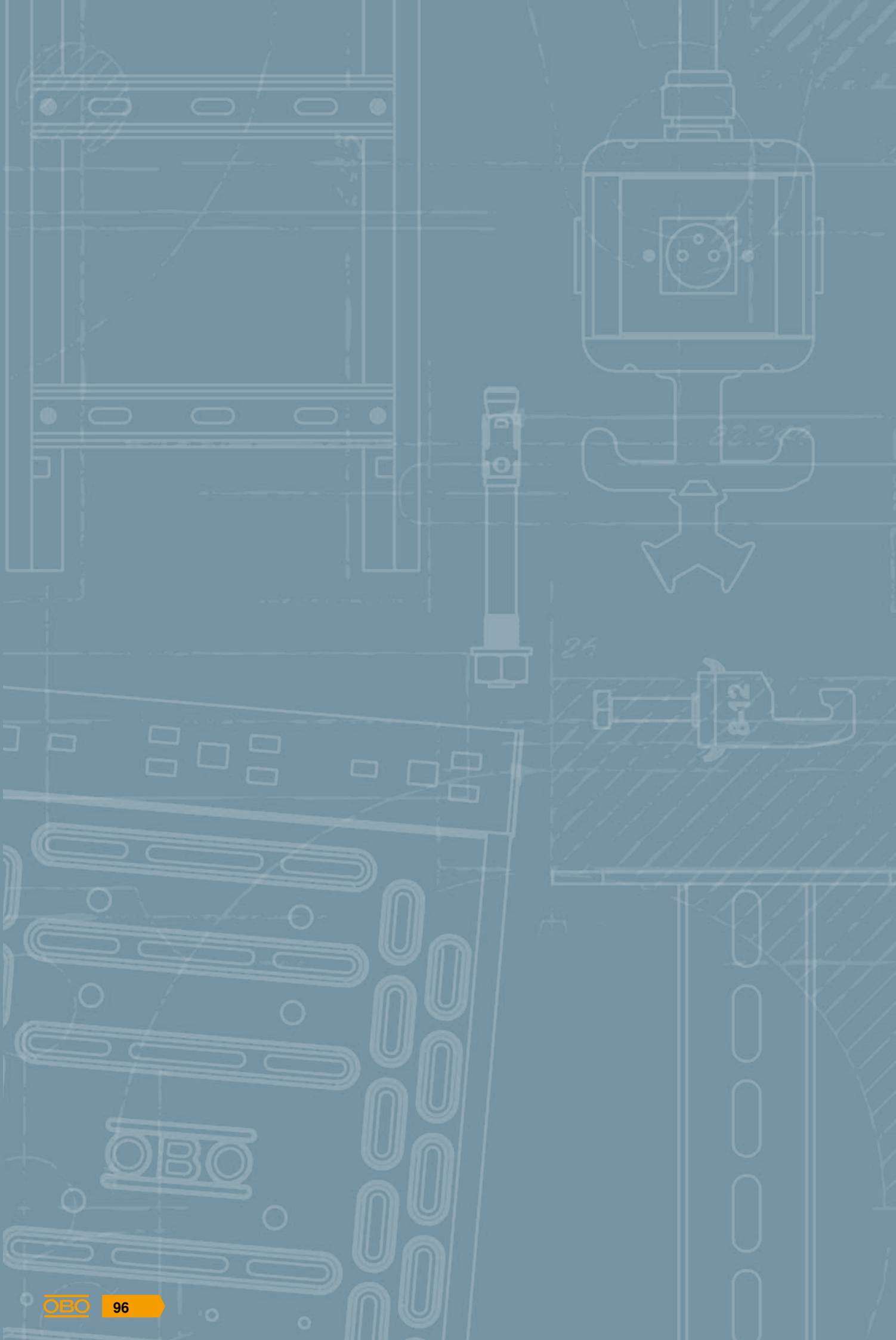

Cable ladders



Riveted cable ladder systems

98



Welded cable ladder systems

102



Wide span cable ladder systems

106



Vertical ladder systems

110



System description



The high load capacity and good ventilation of the OBO cable ladder systems can offer tangible benefits, in particular during the installation of power cables. OBO Bettermann's cable ladder systems can be used universally and, due to the continuous rail and rung perforation, offer countless installation benefits. A factor guaranteeing easy mounting is the option of integrated fastening of cables using OBO clamp clips on the rungs, which are available in various different versions. OBO cable ladder systems are shipped partly folded up, thus saving space during

transport and storage. OBO cable ladder systems can be supplied in lengths of 3 m and 6 m, in all standard widths from 200 to 600 mm and with rail heights of 60 and 110 mm. The portfolio is complemented by the wide span cable ladders, which can simultaneously bridge wide gaps and support high cable loads. The wide span cable ladders are available in 6 m lengths, in widths 200 to 600 mm and with rail heights 110 and 160 mm. On the following pages, you can select your preferred mounting variant from the installation diagrams shown.

Installation principle

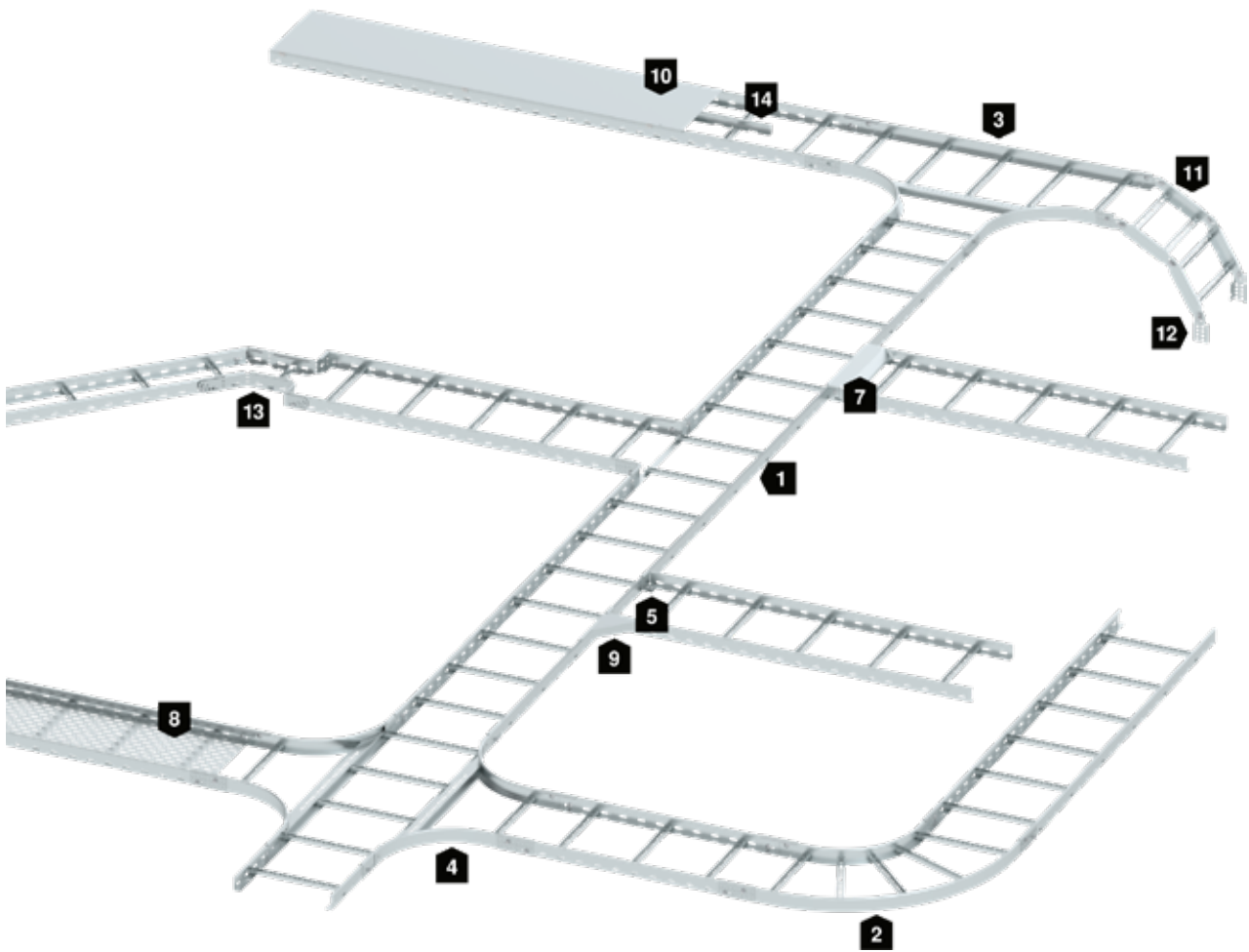

- 1** Cable ladders
- 2** 90° bend, welded
- 3** Tee, welded
- 4** Add-on tee, welded
- 5** Connection piece
- 6** Straight connector
- 7** Support plate
- 8** Inlay plate
- 9** Corner plate
- 10** Cover with cover clamp
- 11** Adjustable bend element
- 12** Adjustable connector
- 13** Multifunctional connector
- 14** Barrier strip



Mounting aid



Suspended support and threaded rod suspension application
Example of mounting cable ladders with suspended supports of U profiles and threaded rod suspension.



Jump application
Implementation of vertical jumps with adjustable connectors, e.g. for ceiling joists.



Centre suspension
Threaded rod suspension of a cable ladder using the centre suspension, type MAHL, and threaded rod, type 2078/M12.



Cable ladder centre suspension with U profile
Mounting of a cable ladder with centre suspension MAHU and a U support.



Suspended support suspension
Suspension of a cable ladder with suspended supports and support brackets.



Straight connection of cable ladders
Straight connection of cable ladders with straight connector, type LVG.



Horizontal angle connection of cable ladders
Horizontal angle connection with straight and angle connectors, type LWVG.



Vertical angle connection of cable ladders
Creation of a vertical angle connection using adjustable connectors, type LGVG.



Mounting of a T exit
Creation of a horizontal T exit of two cable ladders at different heights. The support profile, type LAW, is required to fix two cable ladders.



T exit with support plate

Creation of horizontal tees for cable ladders running at the same height. To increase the cable support and to protect the cables, use support plates, type LALB. Additional supports should be planned for the area of the exits.



Vertical cable exit

The exit plate, type LAB, is used to increase the cable supporting surface for vertically exiting cables and as cable protection.



Screwless barrier strip fastening

Screwless fastening of a barrier strip in cable ladders with hold-down clamp, type KS KL.



Screwed barrier strip fastening

Screwed mounting of the TSG barrier strip through the perforated rung of the cable ladders.



Straight barrier strip connection

Screwless straight connection of barrier strips in cable ladders using the barrier strip TSGV.



Mounting of insertion plate

Mounting of insertion plates, type ELB-L.



Cover mounting

Covers for cable trays and cable ladders can be extended to a locking cover using the cover clamp DK DRLU A2.

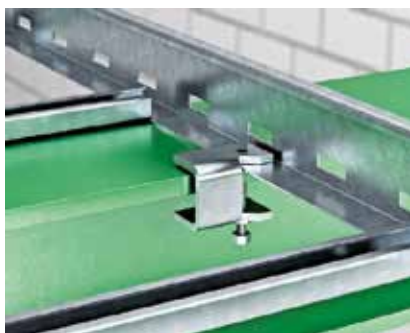

Cable ladder hold-down clamp

Cable ladder hold-down clamp KLL for direct mounting of cable ladders on steel girders.



Earthing terminal/earth connection

Earthing terminal for fastening the equipotential bonding wire to the cable support system.

System description



The high load capacity and good ventilation of the OBO cable ladder systems can offer tangible benefits, in particular during the installation of power cables. OBO Bettermann's cable ladder systems can be used universally and, due to the continuous rail and rung perforation, offer countless installation benefits. A factor guaranteeing easy mounting is the option of integrated fastening of cables using OBO clamp clips on the rungs, which are available in various different versions. OBO cable ladder

systems are shipped partly folded up, thus saving space during transport and storage. OBO cable ladder systems can be supplied in lengths of 3 m and 6 m, in all standard widths from 200 to 600 mm and with rail heights of 45, 60 and 110 mm. On the following pages, you can select your preferred mounting variant from the installation diagrams shown and combine the corresponding articles in the order section.

Installation principle

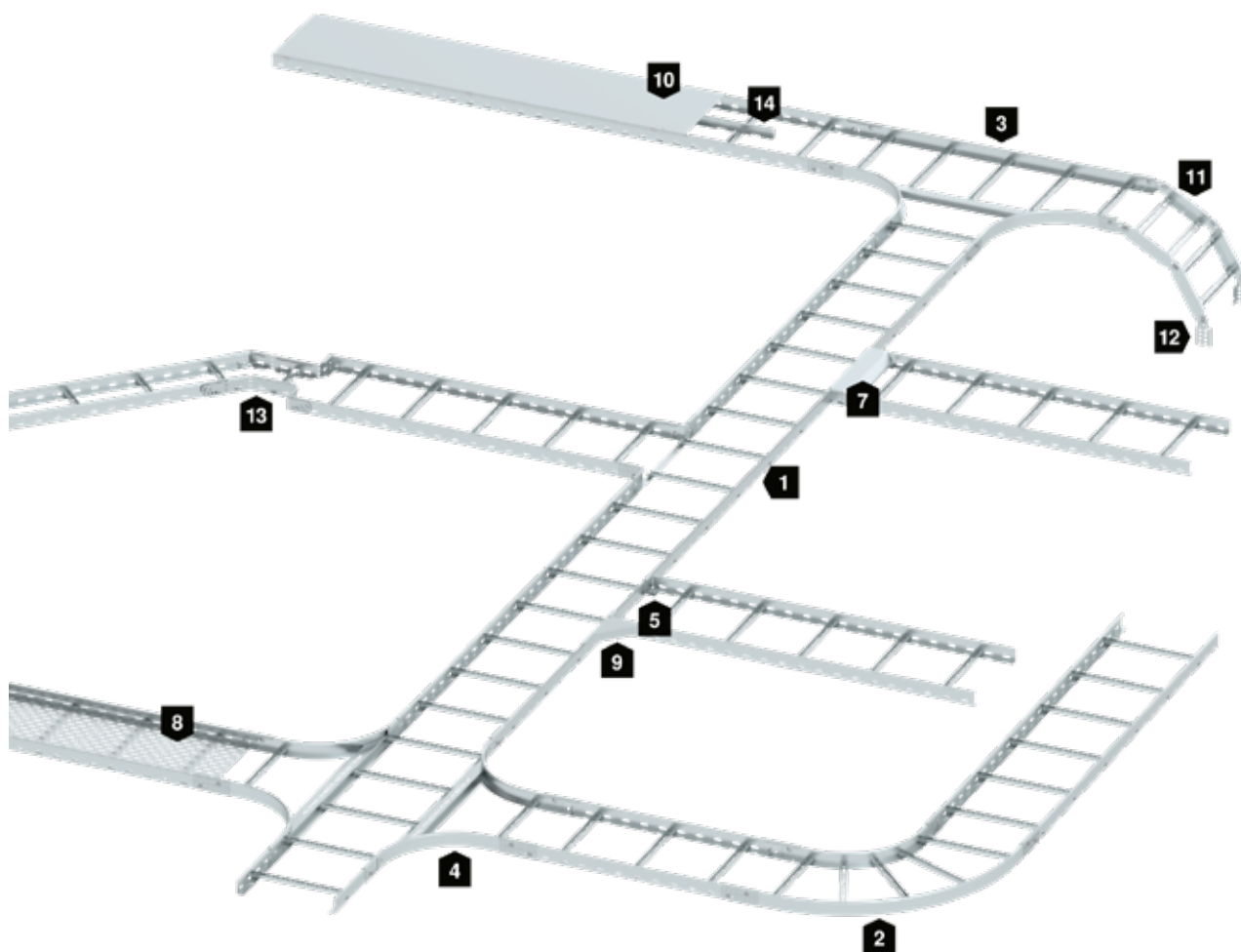

- 1** Cable ladders
- 2** 90° bend
- 3** Horizontal tee
- 4** Add-on tee
- 5** Connection piece
- 6** Straight connector
- 7** Support plate
- 8** Inlay plate
- 9** Corner plate
- 10** Cover with cover clamp
- 11** Adjustable bend element
- 12** Adjustable connector
- 13** Multifunctional connector
- 14** Barrier strip



Mounting aid



Adjustable vertical bend

Adjustable vertical bends made from adjustable vertical bend elements, type LGBE, with adjustable connectors to bridge height offsets.



Add-on tee

Creation of a one-sided branch using an add-on tee, type LAA.



Add-on tee, symmetrical

Mounting two add-on tees, type LAA, on a cable ladder as a symmetrical cross-over.



Mounting of a T piece

Mounting of a T piece, type LT, to create a one-sided branch for cable ladders.



90° bend

Connection of two cable ladders at a horizontal 90° angle with a bend, type LB 90.



Multifunctional connector for cable ladders

Creation of a one-sided branch using a multifunctional connector, type LMFV.



Multifunctional connector for cable ladders

Creation of a reduction, including 45° angle, using a multifunctional connector, type LMFV.

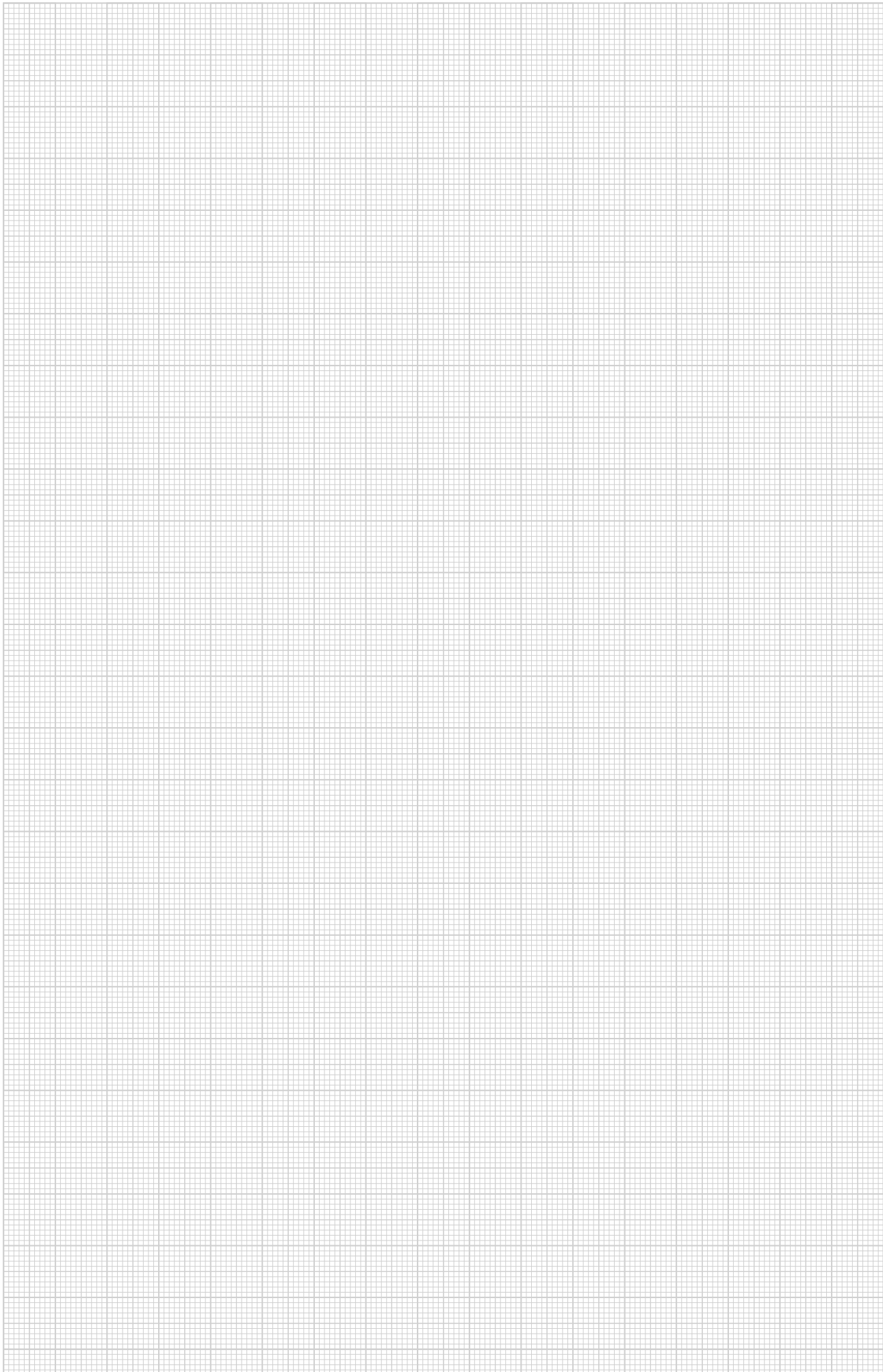

System description



When you need to bridge wide spans and support high cable loads, the OBO wide span systems are the perfect solution. The product range comprises cable trays and cable ladders with widths of between 200 and 600 mm and side heights of 110 to 200 mm. Comprehensive system accessories such as fittings and all the fastening materials for concrete and steel mounting round off this product range perfectly. OBO wide span systems

have proven their worth in many areas of industrial and systems engineering. These systems are becoming ever-more popular in buildings with a steel framework. OBO wide span systems are the complete product range for all applications and requirements and, with their large load capacity combined with large spans, provide efficient and optimised power supply.

Installation principle

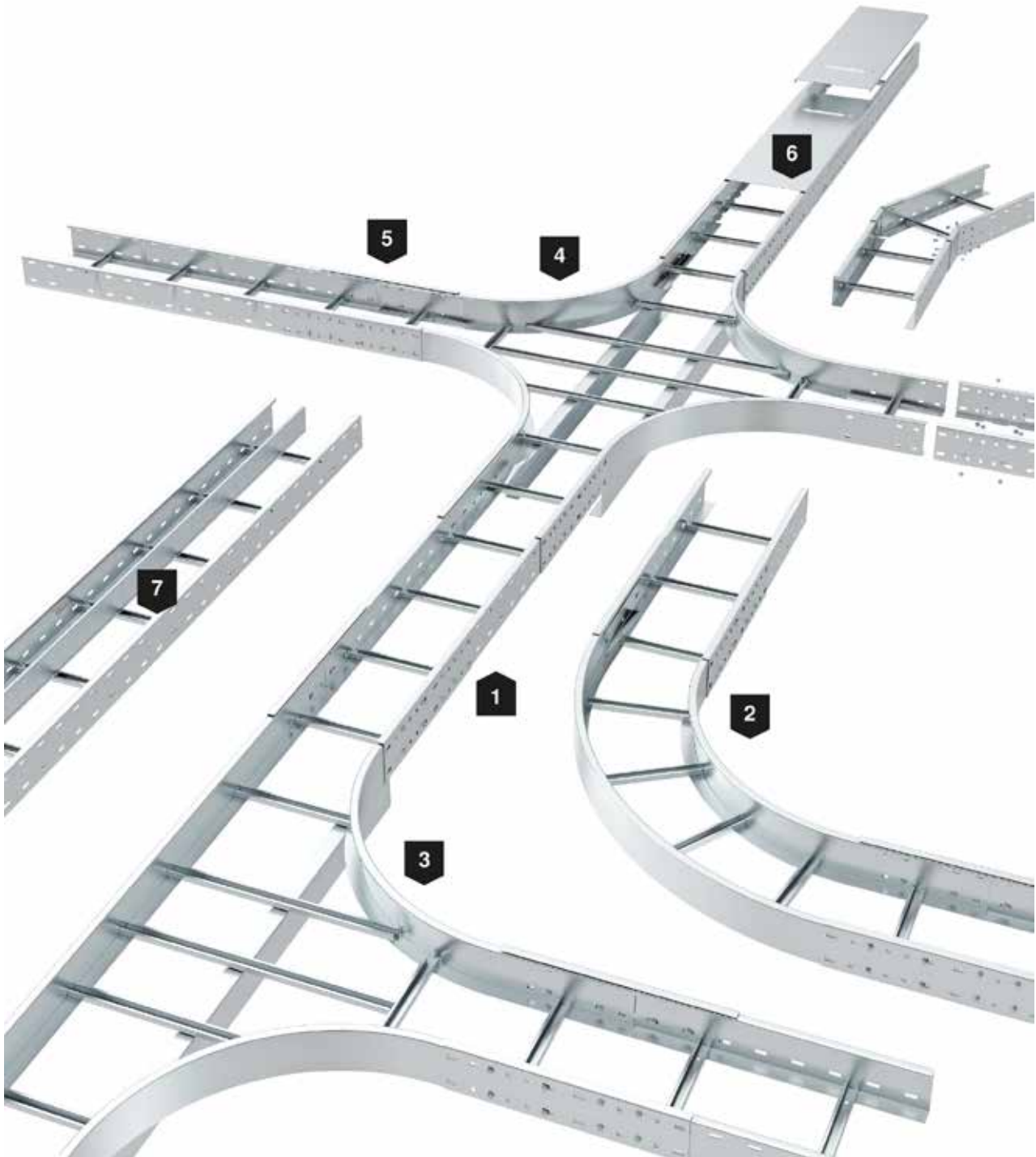

- 1** Wide span cable ladders
- 2** 90° bend
- 3** Horizontal tee
- 4** Cross-over
- 5** Straight connector
- 6** Cover with turn buckle
- 7** Barrier strip

Mounting aid



Wide span fitting application
Mounting examples for horizontal and vertical changes of direction for wide span systems.



Wall mounting application
Direct wall mounting of wide span systems.



Girder clamping application
Mounting of a wide span system clamped to steel girders.



Horizontal wide span angle connection
Horizontal angle connection of wide span cable ladders with angle connectors, type WRWVK.



Vertical wide span adjustable connection
Vertical angle connection of wide span cable ladders with adjustable connectors, type WRGV.



Fastening of wide span cable ladders
Fastening of wide span cable ladders to the bracket using clamp, type LKS 60/5.



Mounting of 90° bend
Bend in combination with wide span cable ladder. The bend is connected to the wide span cable ladder using external connectors.



Mounting of tee
Tee in combination with wide span cable ladder. The tee is connected to the wide span cable ladder using external connectors.



Cross-over mounting
Cross-over in combination with wide span cable ladder. The cross-over is connected to the wide span cable ladder using external connectors.



Screwless barrier strip fastening
Screwless fastening of a barrier strip in wide span cable trays and cable ladders with hold-down clamp, type KS KL.



Screwed barrier strip fastening
Barrier strip mounting in wide span cable ladders. Fastening using slide nuts and hexagonal bolts.



Cover mounting
Mounting of covers with turn buckles.



Wall bracket, heavy duty

Mounting of the heavy-duty wall bracket, type AWSS, with clamping angle, type KWS, to steel girder to accept a wide span system. The wall bracket can also be mounted on concrete walls with bolt ties.



45° adapter plate

Mounting of the 45° adapter plate, type KA-E 45, on the steel girder using clamping angles, type KWS. The adapter plate can also be mounted on concrete walls with bolt ties.



Mounting example

Double-sided suspended support mounting of I profiles with transverse traverse. Fastening of a wide span cable ladder, type WKL 200, with hold-down clamp, type LKS 60/5, on the transverse profile.

System description



OBO vertical ladder systems for vertical routing of all kinds of cables. Available as heavy-duty vertical ladders with U profiles and as industrial vertical ladders with I profiles. Both the heavy-duty and industrial vertical ladders can be assembled in variable lengths. The side rails are standard profiles of type US 5 and IS 8, which are

connected using the appropriate rungs. The continuous rail perforation of the system and the comprehensive accessories simplify and accelerate installation, which can take place either directly on the wall, clamped to a steel construction or also as a free-standing construction. The system is perfectly complemented with OBO clamp clips.

Installation principle



- 1** Light-duty vertical ladder
- 2** Heavy-duty vertical ladder
- 3** Industrial vertical cable ladder
- 4** Cover with spacer
- 5** Rung seat with rung MS4022

Mounting aid



Wall mounting application

Wall mounting of a vertical ladder with mounting angles.



Change of direction application

Implementation of a change of direction with heavy-duty vertical ladder, type SLM.



Free-standing vertical ladder application

Mounting example for free-standing industrial vertical ladders, type SLS, fastened to the ceiling and floor.



Straight connection of vertical ladders

Connection of vertical ladders, types LG and SSL 60, with connectors, type LVG.



Angle connection of cable ladders

Creation of flexible vertical ladder angles with angle connector, type LWVG.



Adjustable connection of cable ladders

Creation of flexible vertical ladder angles with adjustable connector, type LGVG.



Wall mounting, light-duty vertical ladder

Wall mounting of light-duty vertical ladder, type SLL 45, with wall bracket, type WB 30/75.



Direct wall mounting

Direct fastening of the vertical ladders LG and SSL with bolt ties on the wall.



Wall mounting, heavy-duty vertical ladder

Wall mounting of heavy-duty vertical ladder, type SLM 50, with mounting angle, type BW.

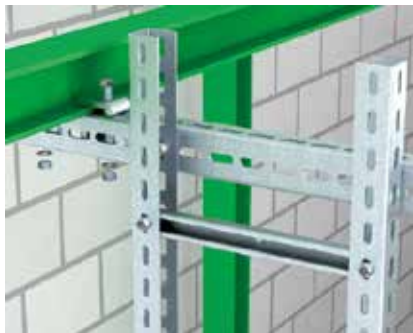

Vertical ladder mounting on steel

Mounting of the heavy-duty vertical ladder, type SLM 50, with cantilever beam made of U profile, on a steel construction.



Cable fastening with clamp clip

Fastening of cables to the rung with clamp clips.



Fastening of industrial vertical ladder

Wall mounting of industrial vertical ladder with mounting angle, type BW 80/55.



Fastening of C profile rung

Fastening of C profile rung, type CK 40, in industrial vertical ladders, type SLS 80.



Fastening of angle rung

Fastening of the angle rung, type WSK 40, in industrial vertical ladders, type SLS 80.



Ceiling fastening

Fastening of a industrial vertical ladder, type SLS 80, to the ceiling using mounting angle, type BW.



Illustration of vertical shaft

Illustration of complete vertical ladder mounting.



Rung seat fixed to IS 8 support

Fastening of the rung seat, type SA, with profile rail, type MS 4022, in I support.



Rung seat fixed to steel girder

Direct fastening (clamping) of the rung seat, type SAA, with profile rail, type MS 4022, on steel girder.



Cover mounting, vertical

Mounting of the cover with spacer on a vertical ladder.

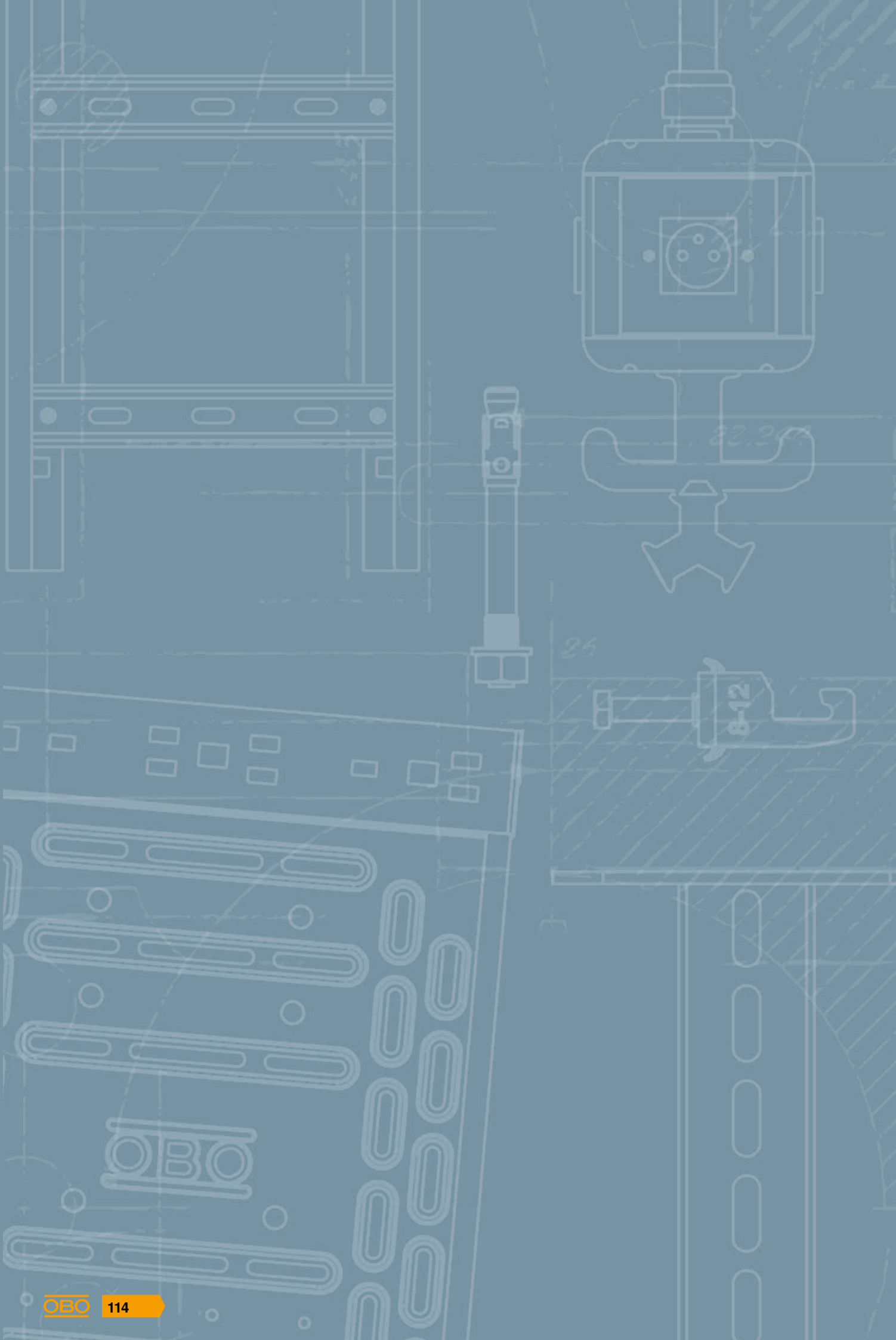

Industrial ducts and trunking

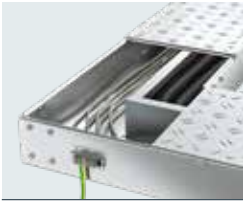

Walkable cable tray system BKRS

116



Metal cable duct LKM

120



AZ small ducts and BKK basic profile

124



Luminaire support systems

128

System description



Optimised for worldwide use in systems construction and in the automotive industry with its automated production lines, the walkable cable tray system from OBO Bettermann is ready for any task. The non-slip, impact-resistant covers and the unperforated cable trays, type BKRS, which serve as the base, are ideally suited to the rough

and tumble of everyday work. Comprehensive accessories, such as support profiles, Z-shaped barrier strips, end closure plates, dust protection, guard plate and all the fastening materials optimise this system for universal use and ensure a flexible system, which allows low-cost installations.

Installation principle

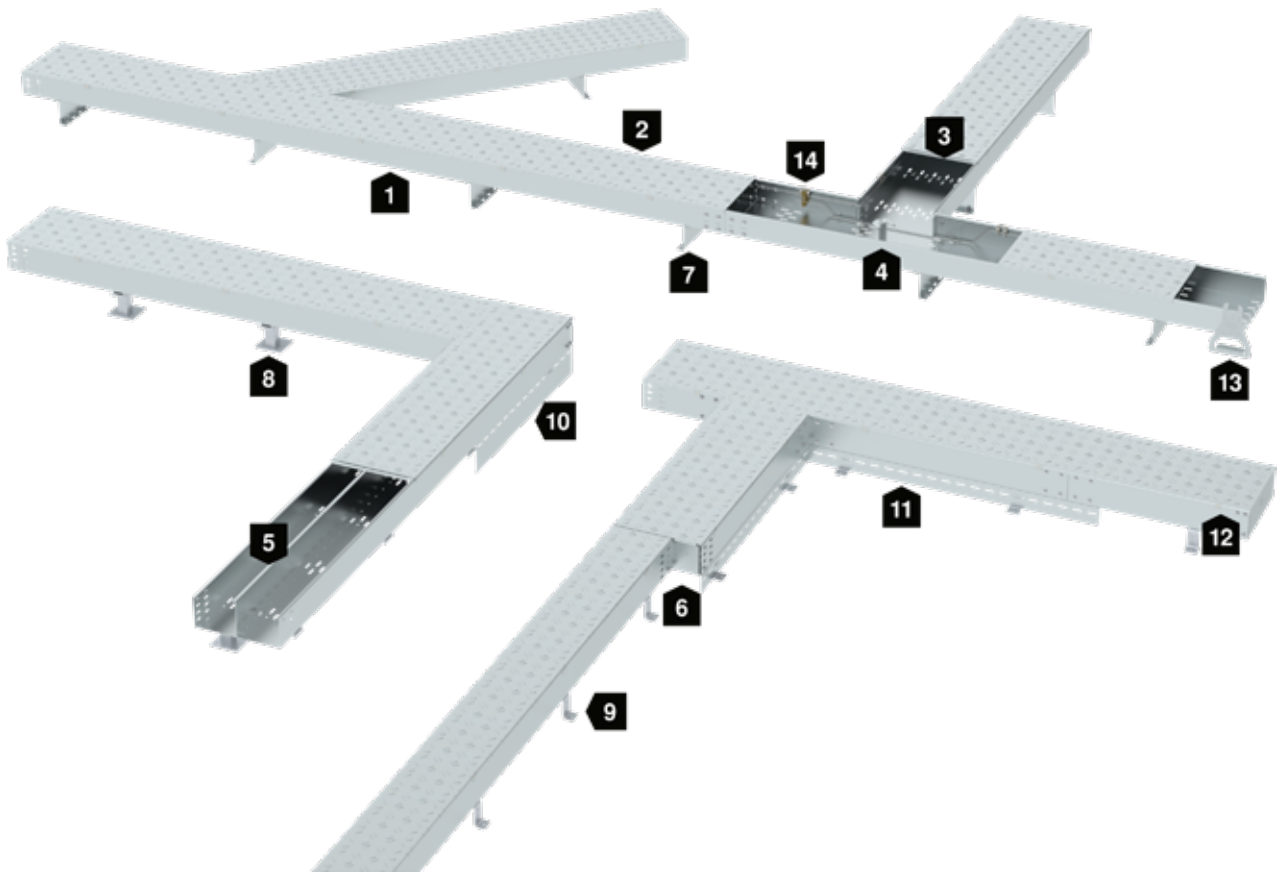

- 1** BKRS cable tray
- 2** Chequer plate cover
- 3** Dust protection element
- 4** Cover support
- 5** Z-shaped barrier strip
- 6** Reducer/stop-end
- 7** Support profile
- 8** Support bracket
- 9** Z support
- 10** Protective panel for support bracket
- 11** Protective panel for Z supports
- 12** Cover clamp
- 13** Cover lifter
- 14** Clamp spring for conductor cable and connection terminal

Mounting aid



Direct floor mounting

Installation of the walkable cable tray system directly on the ground with nail tie or bolt tie.



Stand-off application

Installation and fastening of the walkable cable tray system for floor stand-off using U profiles.



Stand-off with stand-off bracket

Mounting of the walkable cable tray system on stand-off brackets, type DBL.



Stand-off with support profile

Mounting of the walkable cable tray system on Z support STP Z.



Mounting on Z supports, mounting below the walkable cable tray system

When mounting on Z supports, type ZST, other media, such as hydraulic, pneumatic or water, can be mounted under the walkable cable tray system. The protective panel, type SB ZST, is fastened to the Z supports using metal screws, type SPHS.



Mounting on support brackets

Mounting of the walkable cable tray system on special support brackets, type STA BKS.



Mounting below the walkable cable tray system on support brackets

When mounted on support brackets, type STA, other media, such as hydraulic, pneumatic or water, can be laid under the walkable cable tray system. The rails of the support bracket allow the use of U clamps.



Installations when mounted on support brackets

Assignment of the walkable cable tray with different cables, separated by barrier strips. When mounted on support brackets, other media can be laid under the cable tray.



Straight connection

Straight connectors, type RLVL, are used to create a straight connection of the walkable cable tray system.



Mounting protective panel

The protection panel type SB is fastened with drilling screws type BS to the support brackets and is designed to protect people, to prevent accidental stepping down from the walkable cable tray system and therefore to avoid accidents.



Mounting of barrier strip

The barrier strip, type TSG, is screwed by means of truss-head bolts in the bottom of the cable tray. Depending on the width of the cable tray system, multiple barrier strips can be used. Here, the barrier strip also serves as a cover support.

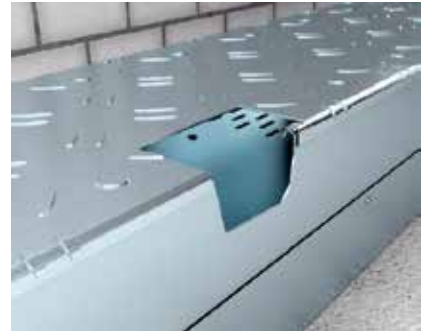

Cover mounting

The cover is mounted on the cable tray using the cover clamp.



Releasing the cover

The cover clamps can be released from the cable tray using a cover lifter.



Drilling template

The cover lifter can be used as a drilling template to mark the hole for the connector.



Creating changes of direction 90°

The cable trays are cut with appropriate tools so they lie flush against each other. Then they are pushed into each other and connected with angled straight connectors.



Using universal connectors

The universal connector has a wide range of individual applications and can be used for both cross-overs as well as route installation.



Using the cover support for fittings

If fittings are used, the additional cover support, type DST, is used which reliably prevents a sagging of the cover with larger dimensions. The cover support is fixed with screws in the bottom of the cable tray/the fitting.

System description



LKM metal cable duct has two areas of application. The stable system for the guidance and protection of cables is used in the field of machines and systems. The completed system allows simple installation at a later date, also with pre-terminated connectors, offering reliable protection against mechanical loads and soiling.

The LKM cable duct of type LKM 20030FS and 60100FS has also been tested as a cable-specific routing type for the maintenance of electrical function according to DIN 4102 Part 12.

Installation principle



- 1** Duct
- 2** Duct clamp for the maintenance of electrical function
- 3** Joint connector
- 4** Internal corner
- 5** External corner
- 6** T piece
- 7** Flat angle
- 8** End piece
- 9** Edge protection ring
- 10** Partition
- 11** Cable brackets
- 12** Duct clamp

Mounting aid



Machines application area

In the area of machines, the LKM metal cable routing duct is used to provide additional protection for the cables.



Corridor, stairwell application area

The stable LKM metal cable routing duct can be used anywhere, in which cables require mechanical protection.



Machine duct mounting

Screw the LKM metal cable routing duct to the machine, for example, using cylinder head bolts of type 341.



Wall duct mounting

Knock-in anchors of type 910/SD can be used to fasten the LKM duct directly on the wall.



Internal corner mounting

As with the LKM duct, the fittings are mounted at the appropriate points.



Joint connector mounting

After installing the LKM duct, lock the joint connector into the parts to be connected from inside. This guarantees the equipotential bonding between these two parts.



Partition mounting

Insert the partition into the straps located on the floor. This guarantees equipotential bonding without any additional aids.



Cable bracket mounting

The cable bracket is mounted using the duct fastening screw. The cables can be held using cable ties, type 555.



Installation of duct clamp

The duct clamp is placed on the loop perforation in the base and then locked into the cover contour. If a partition wall is also installed, the partition wall must be separated into sections.



Equipotential bonding

Equipotential bonding is guaranteed between the cover and the base through the special cover contour. The LKM duct is earthed using the connection strap located in the base.



Edge protection ring mounting

Place the edge protection ring on the open ends of the LKM duct. It prevents damage to the cables within.

System description



The modular systems – the product range that knows no bounds. Exiting branches to individual consumers can be implemented with the AZ small duct. The BKK basic profile can be used as a cable link in chemical plants, where large distances and high cable loads must be bridged

safely with some fairly large support spacings. Electrical drives, such as motors, etc. are connected using the motor connection column. Thus, the modular system, together with the individually combinable range of accessories, is the universal solution for any task.

Installation principle

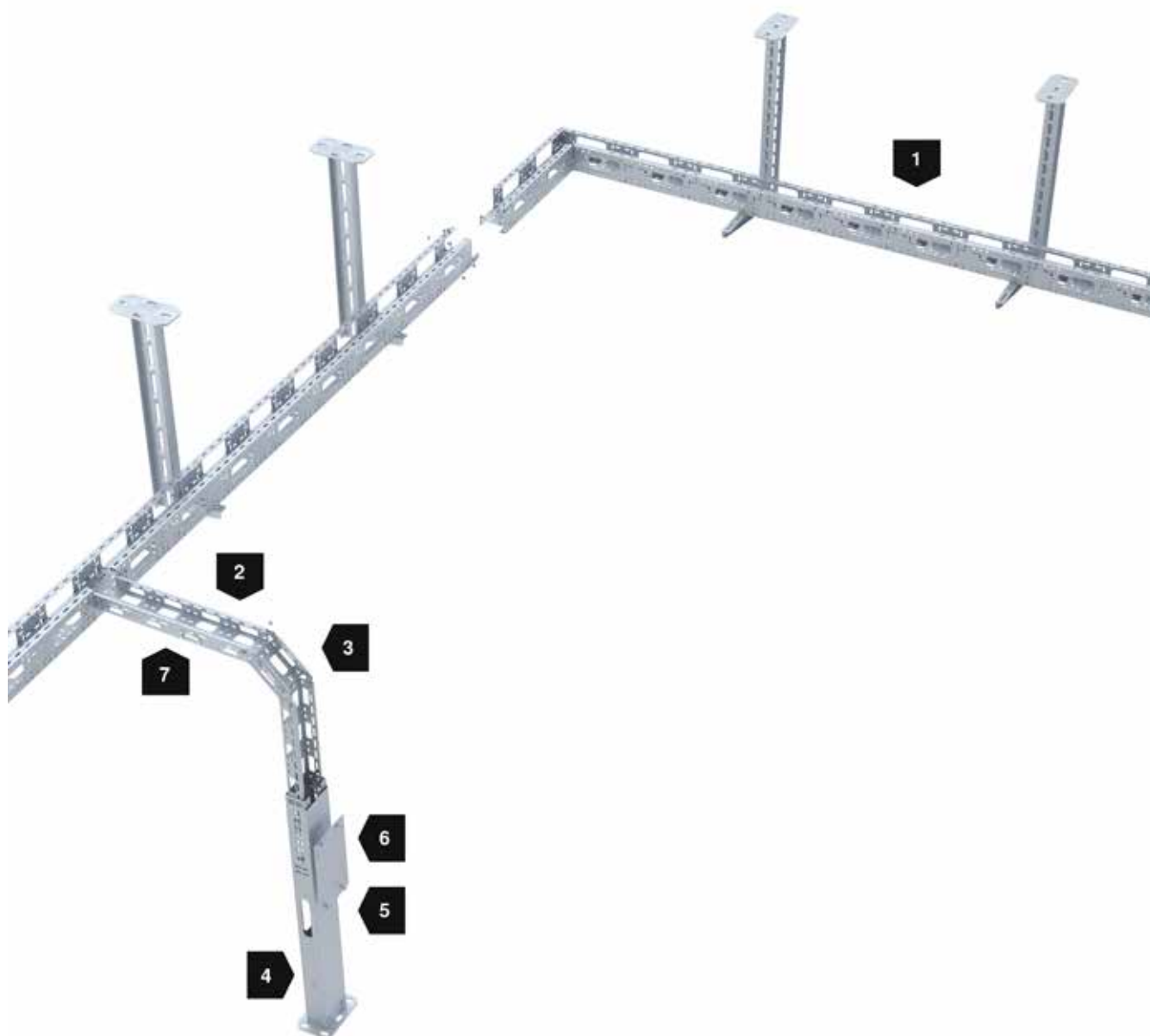

- 1 BKK basic profile
- 2 AZ small duct
- 3 Straight and angle connector
- 4 Motor connection column
- 5 Cover for motor connection column
- 6 Device plate
- 7 Edge protection ring

Mounting aid



BKK system

Mounting of the BKK system under the ceiling using IS 8 supports.



Motor connection column

Coupling of electric drives to the motor connection column.



AZ small duct

Example of mounting the AZ small duct as suspension with threaded rod and the implementation of horizontal-vertical transitions.

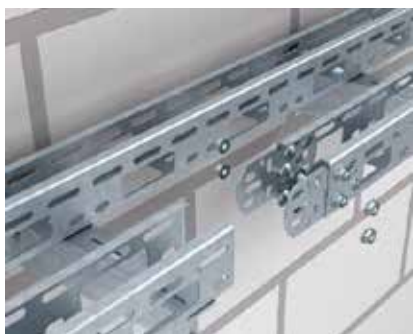

Straight connection of AZ small duct

Straight connection of AZ small ducts with connectors of type VF AZK.



90° angle connection

Angle connection of AZ small ducts with connectors of type VF AZK.



Vertical straight connection

Vertical angle connection of AZ small ducts with two connectors of type VF AZK.



90° vertical bend, falling

Mounting of a falling vertical bend with adjustable connectors, type SV.



90° vertical bend, rising

Mounting of a rising vertical bend with adjustable connectors, type SV.



Side rail cable protection ring

Insertion of the cable protection rings, type KSR-DR 910, in the side rail of the AZ small duct.



Cover fastening

Mounting of the cover, type AZDMD, on an AZ small duct.



Mounting of motor connection column with fastening bracket

Fastening of the motor connection column, type MAS 140/10, to the wall using fastening brackets, type BF 140/10.



Device plate mounting

Mounting of the device plate, type GP, to the motor connection column.



Joint connection

Connection of straight joints in the BKK system using the joint connector, type SSV.



Mounting of base profile

Mounting of the base profile in the BKK system.



BKK straight fastening variant

Possible mounting variant of BKK profiles with straight joint.



BKK offset fastening variant

Possible mounting variant of BKK profiles with offset joint. This mounting variant provides increased joint stability.



Angle connection

Simple bend creation with hinge connectors, type SV. For this, the side rails must be cut.

System description



Whether in industry, in purpose-built buildings or in especially attractive buildings, OBO luminaire support systems simplify the installation of light systems in many areas of industry and buildings. They are also suitable for

flexible power and data supplies to machines and workstations. The OBO luminaire support system makes cable laying and the optimum positioning of lighting child's play for any possible application.

Installation principle



- 1** Luminaire support tray
- 2** 90° bend
- 3** 45° bend
- 4** Cover with turn buckle
- 5** Suspension bracket
- 6** Add-on tee
- 7** Threaded rod
- 8** Straight connectors and joint plate
- 9** Cover
- 10** Trapezoidal fastening

Mounting aid



Luminaire support rail application

Suspension of the luminaire support rail with chain and suspension bracket.



Luminaire support tray application

Suspension of a luminaire support tray with centre suspension MAH and threaded rod.



Straight connection of luminaire support trays

Horizontal straight connection of the luminaire support tray, type LTR, with straight connector set, type RV 607.



Straight connection of luminaire support tray

Horizontal straight connection of the luminaire support rail, type LTS with straight and angle connector, type VF AZK.



Horizontal angle connection

Horizontal angle connection of the luminaire support rail, type LTS with straight and angle connector, type VF AZK.



Vertical straight connection

Vertical straight connection of the luminaire support rail, type LTS, with two straight and angle connectors, type VF AZK.



Side rail cable protection ring

Insertion of the cable protection rings, type KSR 910, in the side rail of the luminaire support rail.



Bottom cable protection ring

Insertion of the cable protection rings, type KSR 915, in the bottom of the luminaire support tray.



Chain suspension

Implementation of a chain suspension for luminaire support systems with anchor, ceiling hook, type 948/TG6, and suspension chain, type LTK-K.



Centre suspension

Efficient creation of centre suspensions. The luminaire support tray is fastened to the centre suspension without bolts.



Prewired luminaire supports

Mounting of a pre-terminated luminaire beneath a luminaire support rail.



Mounting of luminaire support fitting

Mounting of luminaire support fittings by simple interconnection of fitting and luminaire support rail.

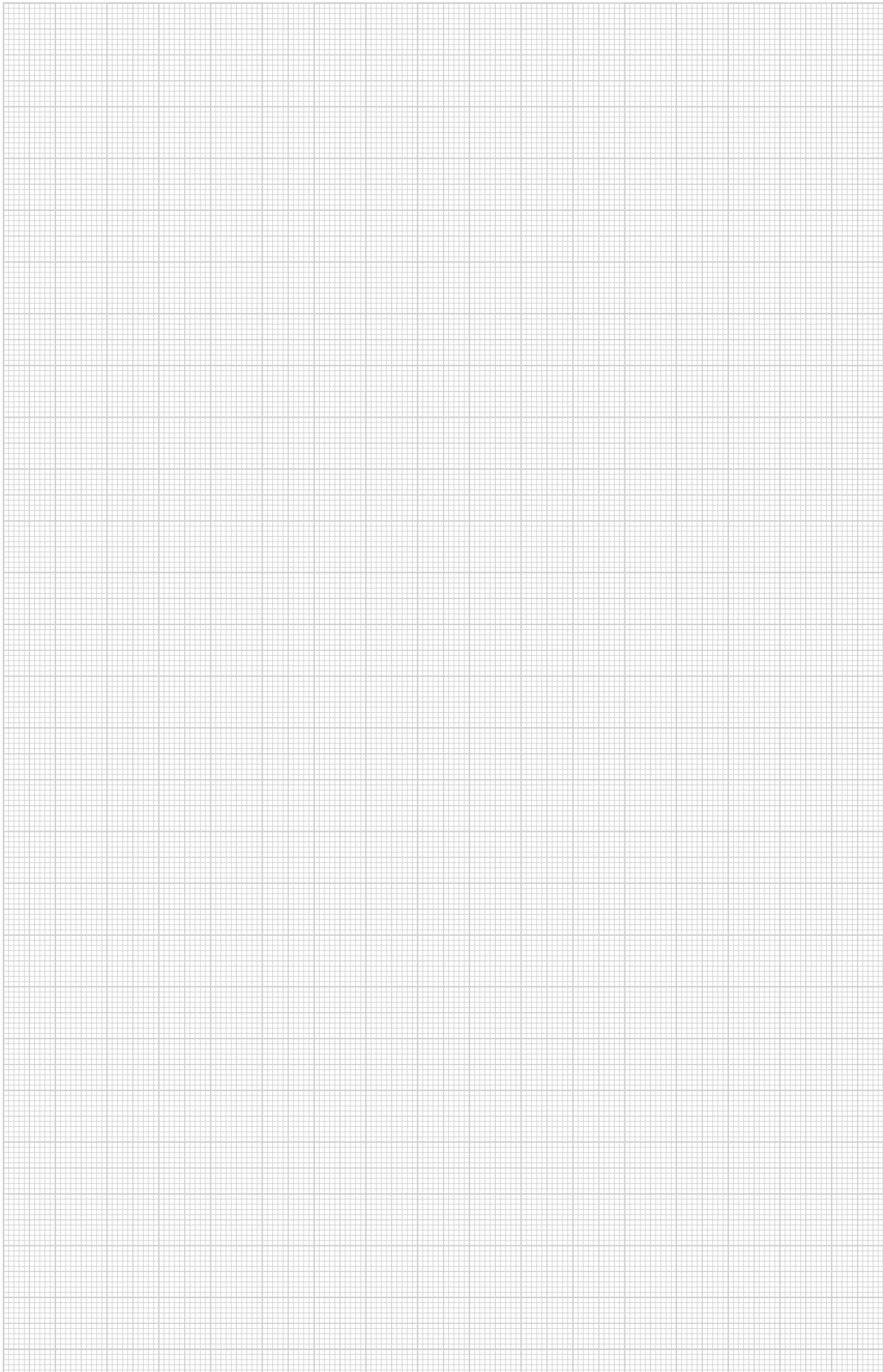

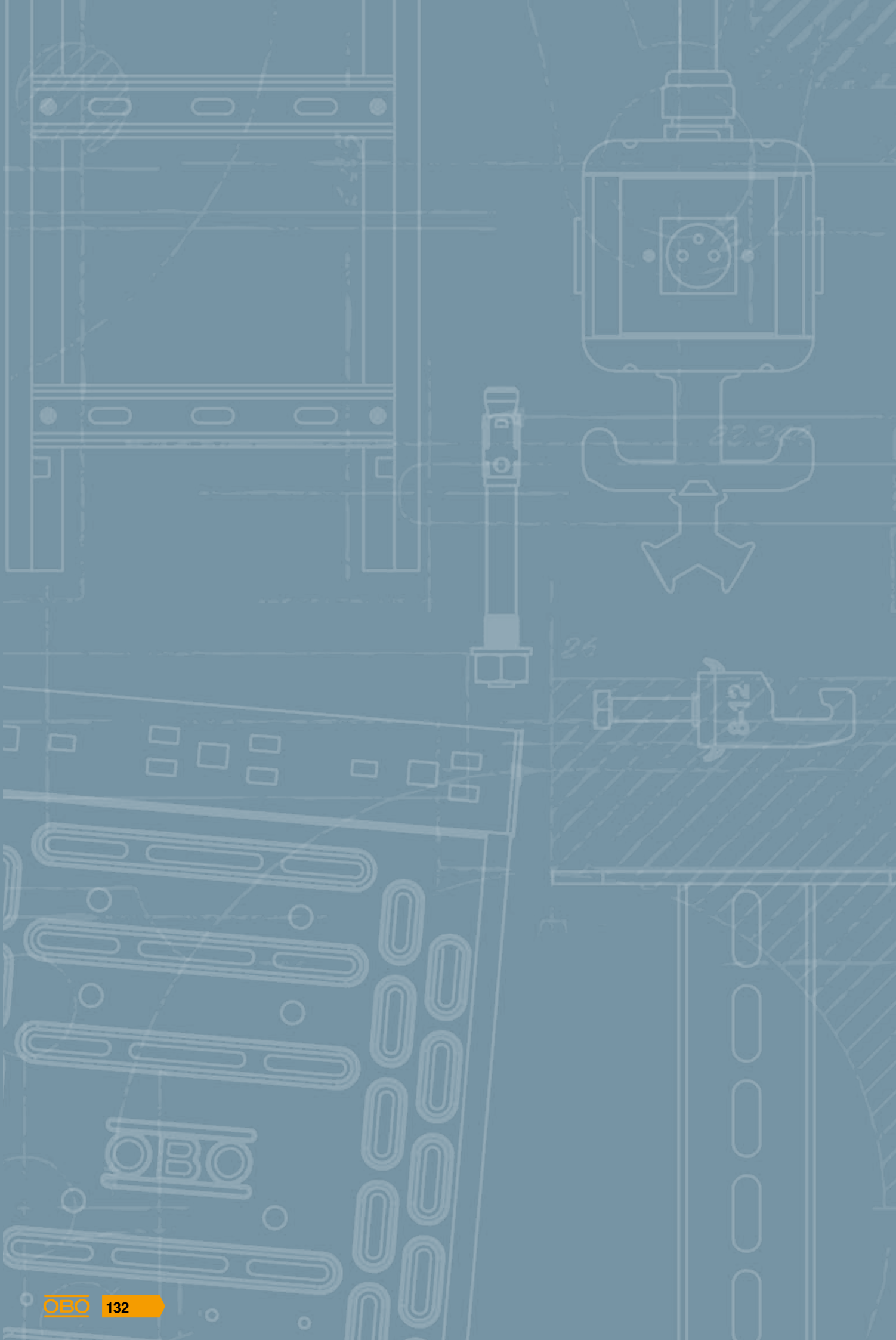

Support structures



Suspended supports and brackets

134



Universal systems

150



Cable support troughs

154



Clamp fastening systems

156

System description

TP supports and brackets



The TP system is a range of light supports and brackets. This product range, which consists of TP suspended supports and brackets, can be used universally as ceiling and wall mounting.

Installation principle
TP supports and brackets



- 1 TP suspended support
- 2 TP support/wall and support brackets
- 3 Spacer
- 4 End cap

Mounting aid

TP supports and brackets



Ceiling mounting of TP wall and ceiling clamp
Universal mounting of the TPD wall and ceiling clamp on the ceiling (with DS 4 spacer). Maximum tray width 300 mm.



Mounting of TP suspended support with single-sided bracket fastening
Ceiling mounting of a TP suspended support with spacer DS 4 and one-sided bracket mounting. Maximum tray width 300 mm.



Complete mounting of a TP system
Mounting of the TP suspended support with head reinforcement and double-sided bracket mounting and mounting directly on the wall.

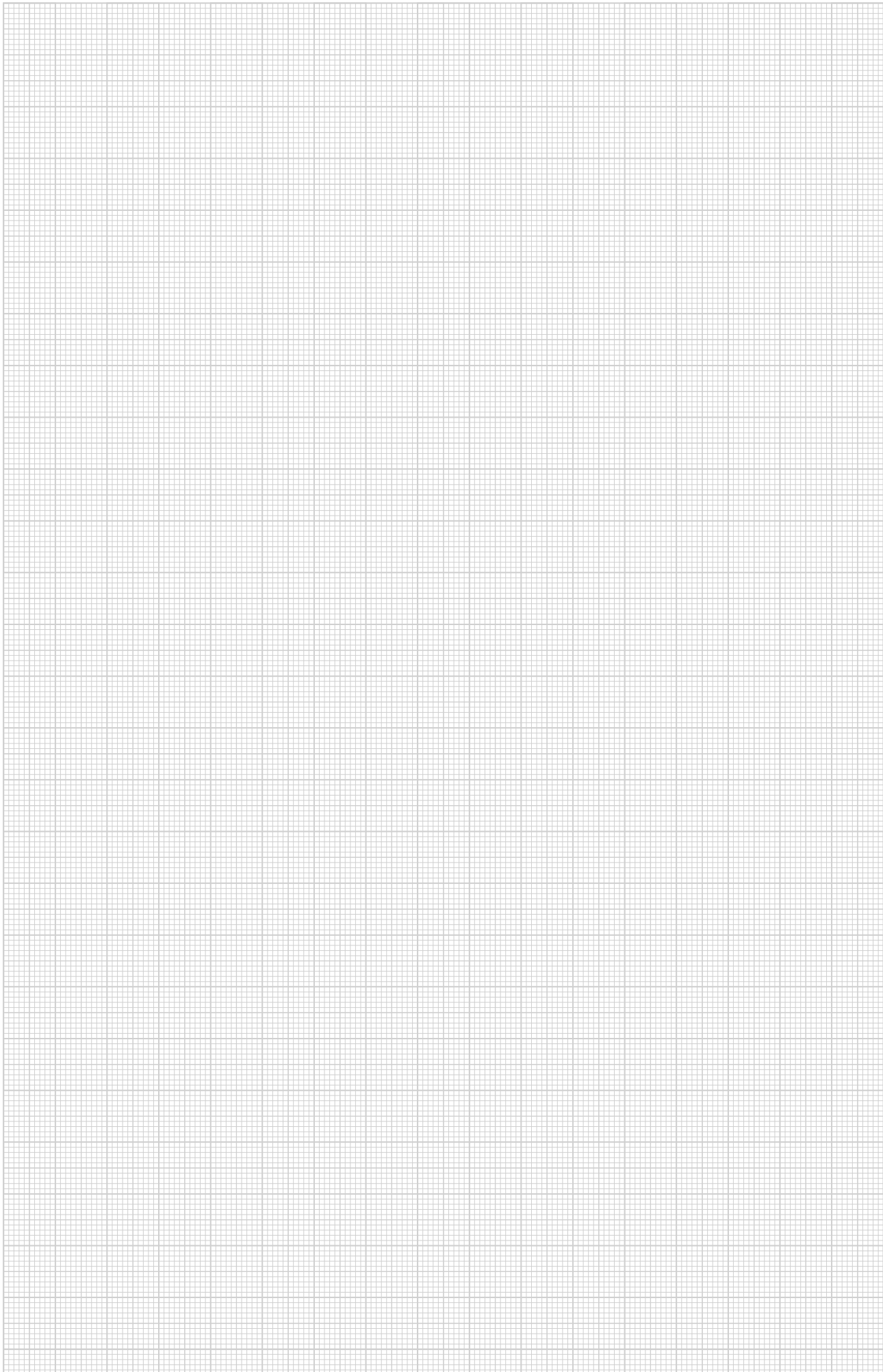

System description

U supports and brackets



The perfectly matched U support family consists of US 3 (light-duty system), US 5 (medium-duty system) and US 7 (heavy-duty system). The U support range is particularly noted for its versatility. The U supports can be used as ceiling suspension, floor stand-off or as construction profiles.

Installation principle

U support US 3

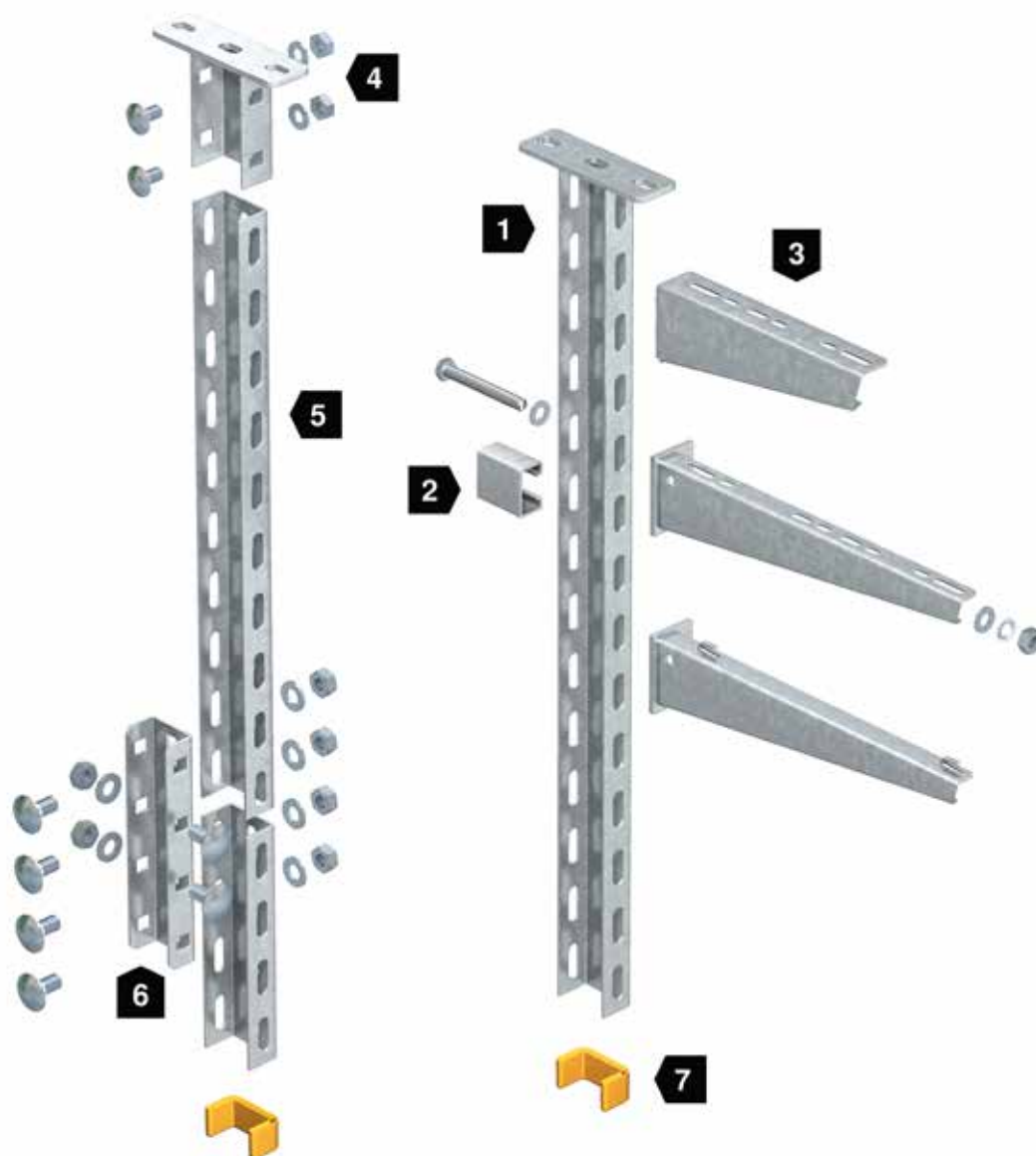

- 1** US 3 suspended support
- 2** Spacer
- 3** Wall and support bracket
- 4** Head plate
- 5** US 3 support
- 6** U support connector
- 7** End cap

Installation principle

U support US 5

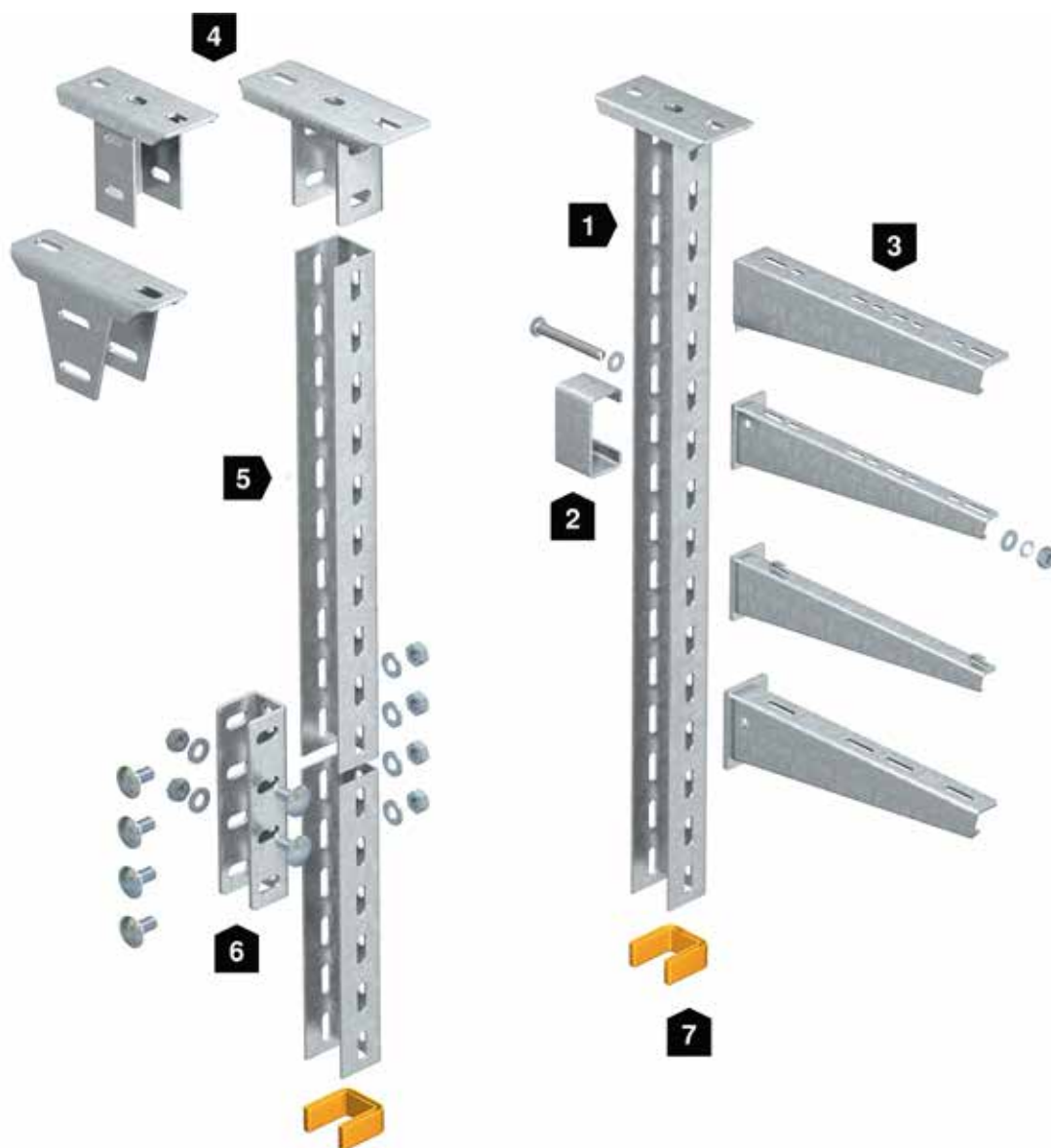

- 1** US 5 suspended support
- 2** Spacer
- 3** Wall and support bracket
- 4** Head plate
- 5** US 5 support
- 6** U support connector
- 7** End cap

Installation principle

U support US 7

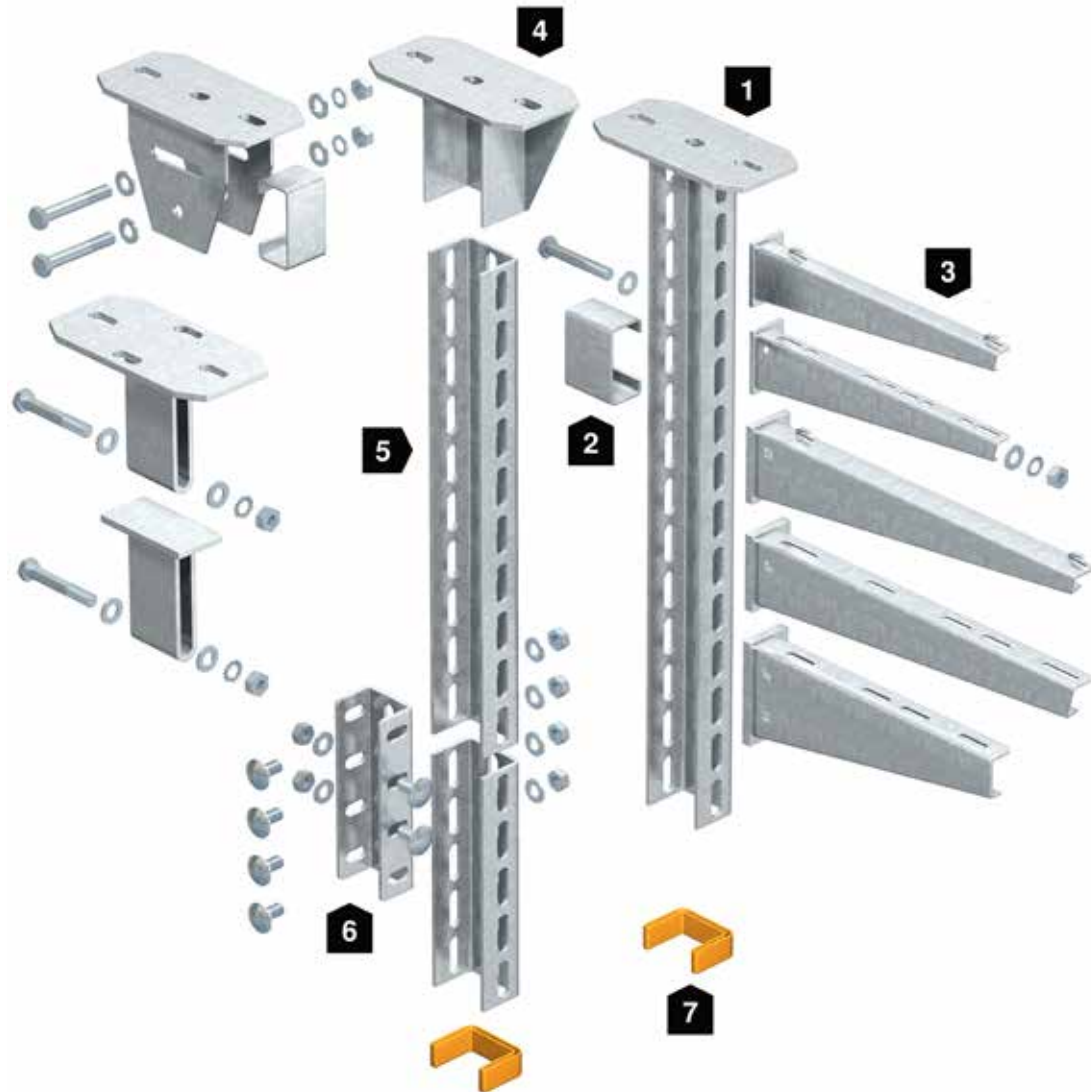

- 1** US 7 suspended support
- 2** Spacer
- 3** Wall and support bracket
- 4** Heavy-duty head plate
- 5** US 7 support
- 6** U support connector
- 7** End cap

Mounting aid

U supports and brackets



Wall mounting

Direct fastening of wall and support brackets of type AW... on the wall.

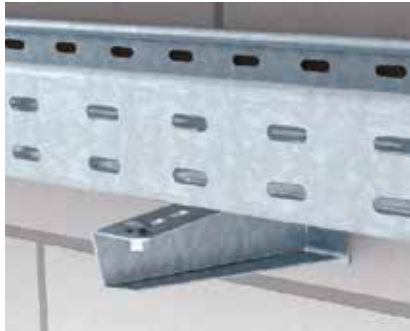

Quick fastening of cable tray on bracket

Positioning the cable tray on the bracket.



Quick fastening of cable tray on bracket

Fixing of the cable tray on the bracket using quick fastening.



Wall bracket, variable

Fastening of the variable wall bracket, type AWW, with bolt tie to vaulted or sloping walls/ceilings.



Standard mounting of suspended support with wall bracket, single-sided without spacer

Ceiling fastening of a suspended support with single-sided bracket fastening. A spacer is not always required for widths up to and including 300 mm.



Standard mounting of suspended support with wall and support bracket, single-sided with spacer

Ceiling fastening of a suspended support with single-sided bracket fastening. For widths of over 400 mm, we recommend using a spacer.



Standard mounting of suspended support with wall and support bracket, double-sided

Ceiling fastening of a suspended support with double-sided bracket mounting.



Ceiling mounting

Standard mounting of U suspended supports US 3 K, US 5 K and US 7 K on the ceiling with fastening of the wall and support brackets.



Head plate mounting

Mounting of the standard head plate on support and ceiling. Use with spacer DSK 25 (US 3), DSK 45 (US 5) or DSK 61 (US 7).



Adapter head plate, asymmetrical

Asymmetrical head plate KA-ASY to increase the load capacity for the combination with suspended supports, type US 7 K and IS 8 K.



Adapter head plate, symmetrical

Symmetrical head plate KA-SY to increase the load capacity for the conjunction with suspended supports, types US 7 K and IS 8 K.



Traverse

Mounting of U suspended supports US 3 K, US 5 K and US 7 K under the ceiling using bolt ties and a trapeze, consisting of U profile US 3, US 5 or US 7.



U support wall mounting

U supports are mounted on walls or girders using bolt ties, directly through the system perforation in the U support.



U support connection

To connect U supports, use the appropriate U support connectors, types VUS 3, VUS 5 and VUS 7.



Mounting of spacer

Mounting of the spacer DSK 47 with US 5 supports or DSK 45 with US 7 supports in conjunction with a variable head plate KU 5 V or KU 7 VQP.



Variable head plate with US 3 support

Mounting of the variable head plate, type KU 3 V on US 3 support.



Variable head plate

Fastening of the variable head plate KU 5 V to sloping concrete ceilings using bolt ties and spacer DSK 47.



Variable head plate

Fastening of the variable head plate KU 7 VQP to sloping concrete ceilings using bolt ties and spacer DSK 45.



45° adapter plate, concrete mounting

Mounting of the 45° adapter plate, type KA-E 45, on a concrete wall. For additional support and implementation of tray routes at angles and room corners.



45° adapter plate, steel clamping

Mounting of the 45° adapter plate, type KA-E 45, on the steel girder using clamping angles or chuck jaws. For additional support of routes in angles and at room corners.



Direct girder clamping

Direct girder clamping of a U suspended support using KWS clamping angle. Route in longitudinal direction of steel girder.



Steel clamping with C profile, route in longitudinal direction

U suspended support mounting, clamped to steel girder with C profile, type MS 4022, and TKH-L-25 light-duty chuck jaw. Route along steel girder.



Steel clamping with C profile, route in transverse direction

U suspended support mounting, clamped to steel girder with C profile, type MS 4022, and TKH-L-25 light-duty chuck jaw. Route transverse to steel girder.



Head plate mounting

Installation of the head plate using the example KU 7 AOX for direct welding on steel girders.



Cantilever beam on steel

U supports can be used as cantilever beams on steel girders with chuck jaws of type TKS-L-25. Use DSK spacers for safe functioning.



Clamp fastening of heavy-duty brackets

Clamp fastening of a heavy-duty bracket with clamping angles or chuck jaws on a vertical steel girder.

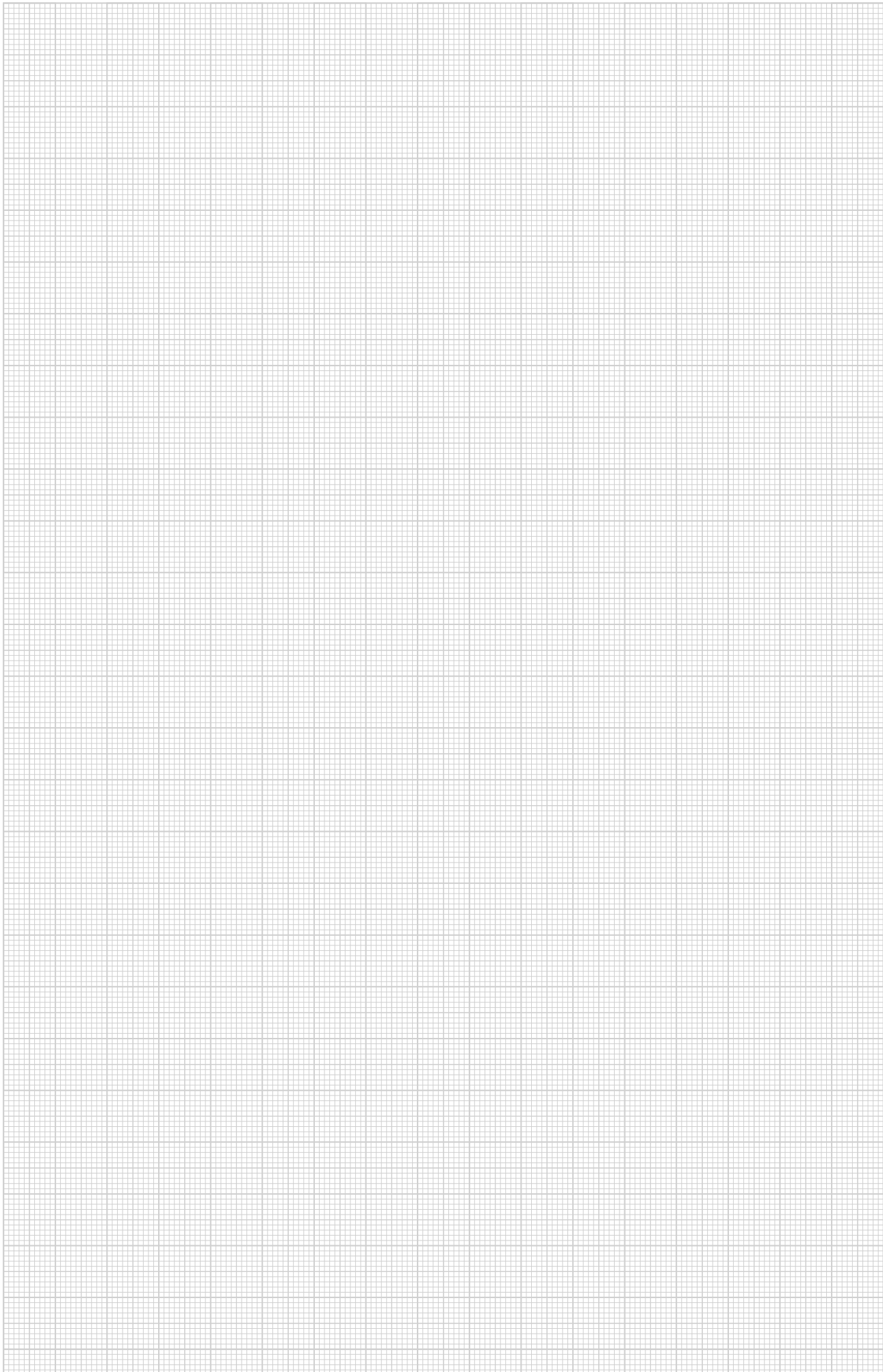

System description

I supports and brackets



The I support system from OBO Bettermann really comes into its own in situations where high loads must be carried, large distances must be bridged and difficult routes must be implemented. The I support system fulfils all the requirements of a heavy-duty mounting system. The high load capacities of all the system components permit the mounting of complex structures. The comprehensive range of head plates allows the implementation of all

conceivable solutions. This heavy-duty system is used with large support spacings of wide span systems or for multi-layer set-ups of standard cable trays and cable ladder systems. The combination of I supports and support brackets of type AS 15, AS 30 and AS 55 form a perfectly matched product range, the height of which can be infinitely adjusted.

Installation principle

I supports and brackets

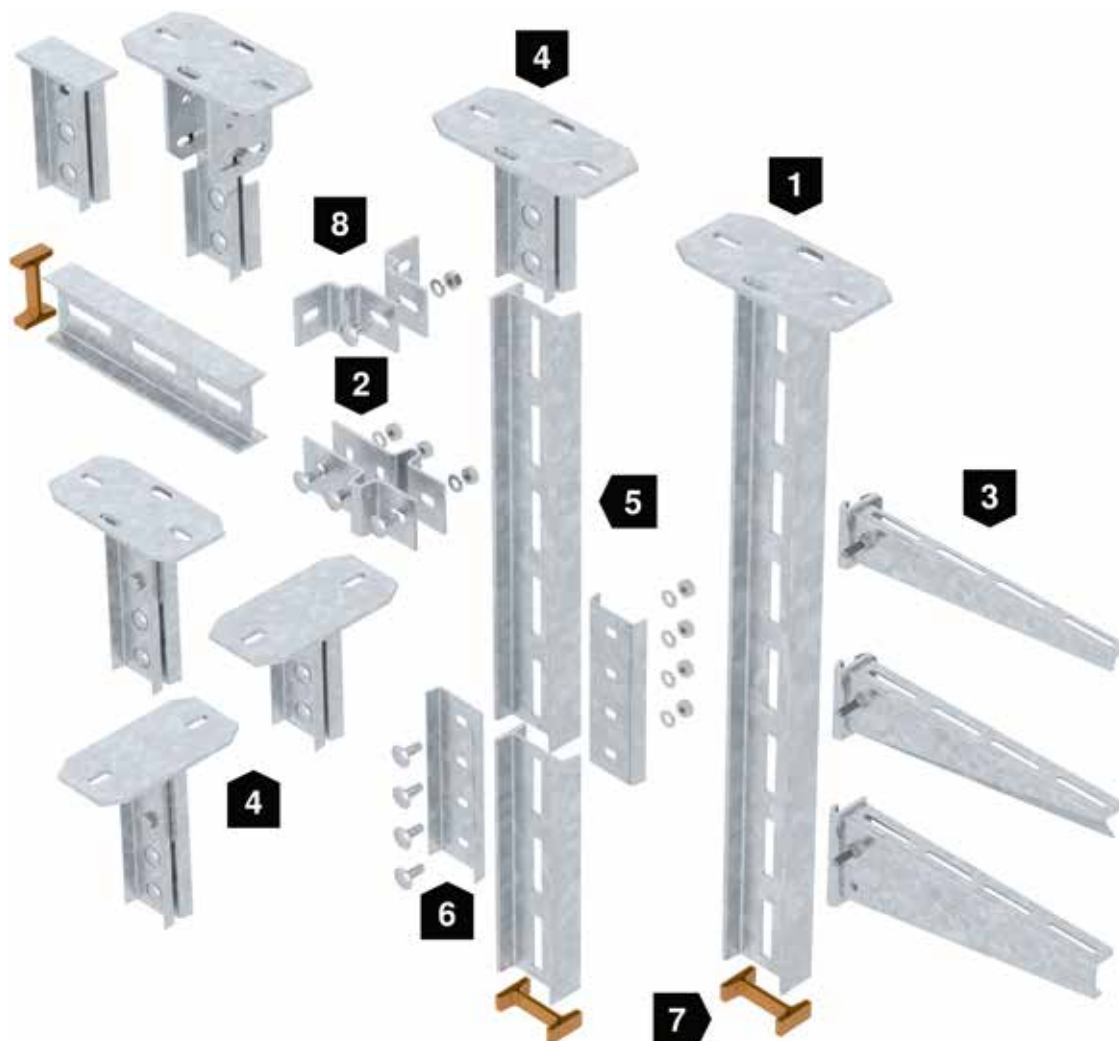

- 1** I suspended support
- 2** Carrier lug
- 3** Support bracket
- 4** Head plate
- 5** I support
- 6** I support connector
- 7** End cap
- 8** Mounting angle

Mounting aid

I supports and brackets



Application on the ceiling

Standard mounting of suspended supports to concrete ceilings using bolt ties.



Head plate mounting

Fastening of the standard head plate, KI 8, for I suspended supports to concrete ceilings using bolt ties.



Head plate, variable (rotated through 90°)

Mounting of the variable head plate, type KI 8 VLK, rotated through 90°, to sloping concrete ceilings using bolt ties.



Variable head plate

Mounting of the variable head plate, type KI 8 VQP, to sloping concrete ceilings using bolt ties.



I support connection

Mounting of the I support connector VIS 8 to connect IS 8 supports.



Bracket mounting

Mounting of a three-layer cable support system on the concrete ceiling using support bracket mounting AS 15, AS 30 and AS 55.



Adapter head plate, asymmetrical

Asymmetrical head plate KA-ASY to increase the load capacity for the combination with suspended supports, types US 7 K and IS 8 K.



Adapter head plate, symmetrical

Symmetrical adapter head plate KA-SY to increase the load capacity for the conjunction with suspended supports, types US 7 K and IS 8 K.



Wall fastening, I support

Mounting of an I support on the wall using fastening brackets, type BW 80/55, and bolt ties to accept multiple support brackets, type AS.



Special structure

Example of the mounting of a special structure, consisting of I supports (ceiling/wall mounting) with transverse profile and various support brackets, type AS.



Application on steel girder

Clamp fastening of suspended supports on steel girders using various chuck jaws, lengthwise or transverse to the steel girder.



Direct girder clamping

Direct girder clamping of an I suspended support with heavy-duty chuck jaw, type TKS-S-30. Route in longitudinal direction of steel girder.



Steel clamping with C profile, route in longitudinal direction

I suspended support mounting, clamped to steel girder with C profile and TKH-L-25 chuck jaw. Route along steel girder.



Steel clamping with C profile, route in transverse direction

I suspended support mounting, clamped to steel girder with C profile and TKH-L-25 chuck jaw. Route transverse to steel girder.



Head plate, variable (transverse)

Mounting of the variable, transversely adjustable head plate, type KI 8 VLP, on rising or falling steel structures with profile rail, type MS 5030, and clamping angles, type KWH.

System description



Universal systems for cable support structures are used for small loads. Whether the installation is to be a ceiling fastening, wall fastening or a floor stand-off: In the universal systems, you can find functional fastenings with matching system accessories for any application. These suspension systems, which can be called basic installations, include centrally loaded ceiling clamps or

trapezoidal fastenings, which are used with threaded rods and centre suspensions. When using centre suspensions, the load should be even on both sides of the system. If an even load cannot be guaranteed, then other systems should be used.

Installation principle

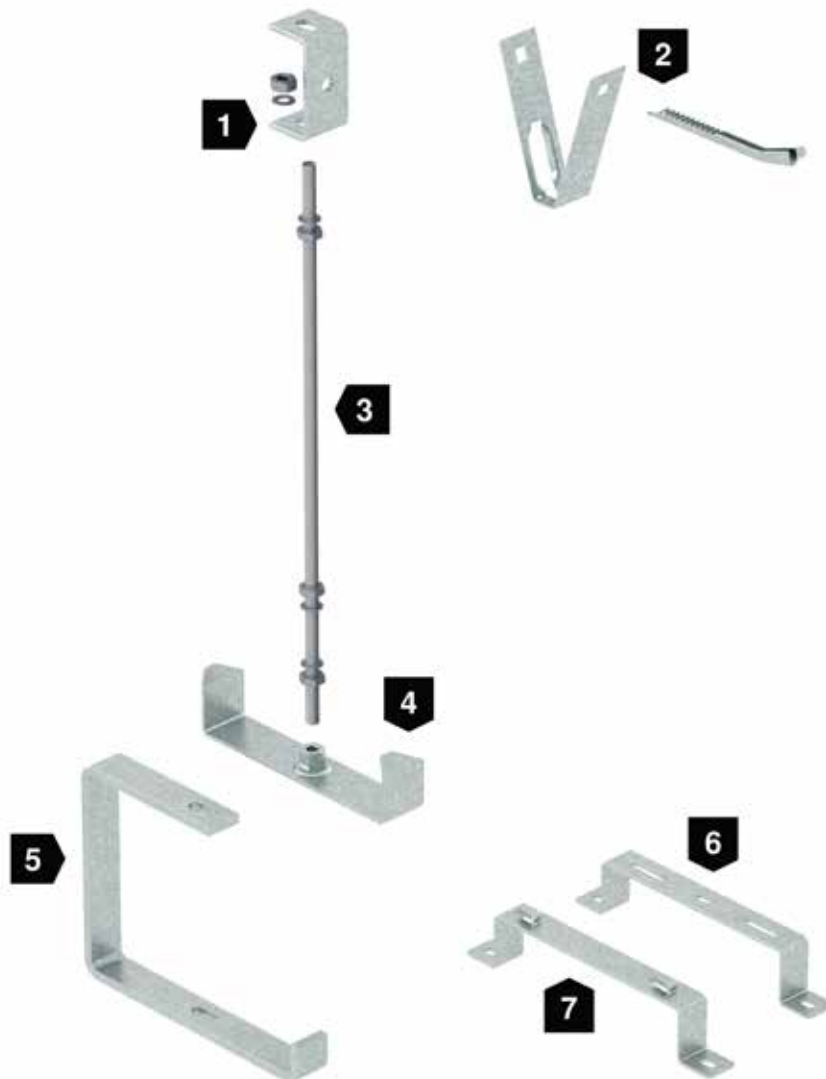

- 1** Ceiling bracket
- 2** Trapezoidal fastening
- 3** Threaded rod
- 4** Centre suspension
- 5** Suspension clamp
- 6** Stand-off bracket
- 7** Stand-off bracket



Mounting aid



Mounting of centre suspension

Mounting of the centre suspension MAH 60 on the ceiling using threaded rod 2078/M10 and ceiling bracket 12050. Maximum cable tray width 300 mm.



Universal mounting on the ceiling

The variable ceiling bracket, type DBV, allows threaded rod suspensions on straight and sloping ceilings.



Centre suspension with threaded rod

Direct centre suspension at low loads of a cable tray with threaded rod 2078/M10.



Mounting of centre suspension

Insertion and alignment of the centre suspension MAH in the cable tray.



Threaded rod suspension RKSM > 400 mm

The threaded rod suspension of RKSM cable trays > 400 mm can take place using two threaded rods.



Cable ladder centre suspension with threaded rod

Mounting of a cable ladder with centre suspension MAHU and a threaded rod.



Trapezoidal plate application

Simple, quick fastening of a cable support system to trapezoidal metal roofs.



Mounting of trapezoidal suspension

Mounting of a cable tray on a trapezoidal ceiling using the trapezoidal fastening, type TPB 100 and centre suspension, type MAH 60. Maximum cable tray width 300 mm. The trapezoidal fastening is mounted using the lock, type TPB R.



Threaded rod suspension with suspension clamp

Ceiling mounting of a cable tray with AHB suspension clamp and threaded rod 2078/M10. Maximum cable tray width 400 mm.



Floor fastening at a distance

Mounting of a cable tray at a distance using the DBL stand-off bracket. Maximum cable tray width 600 mm.



Stand-off of mesh cable trays

Floor stand-off of mesh cable trays with the stand-off bracket, type DBLG 20/... Screwless fastening of the mesh cable tray on the stand-off bracket using clamping lugs.



System description

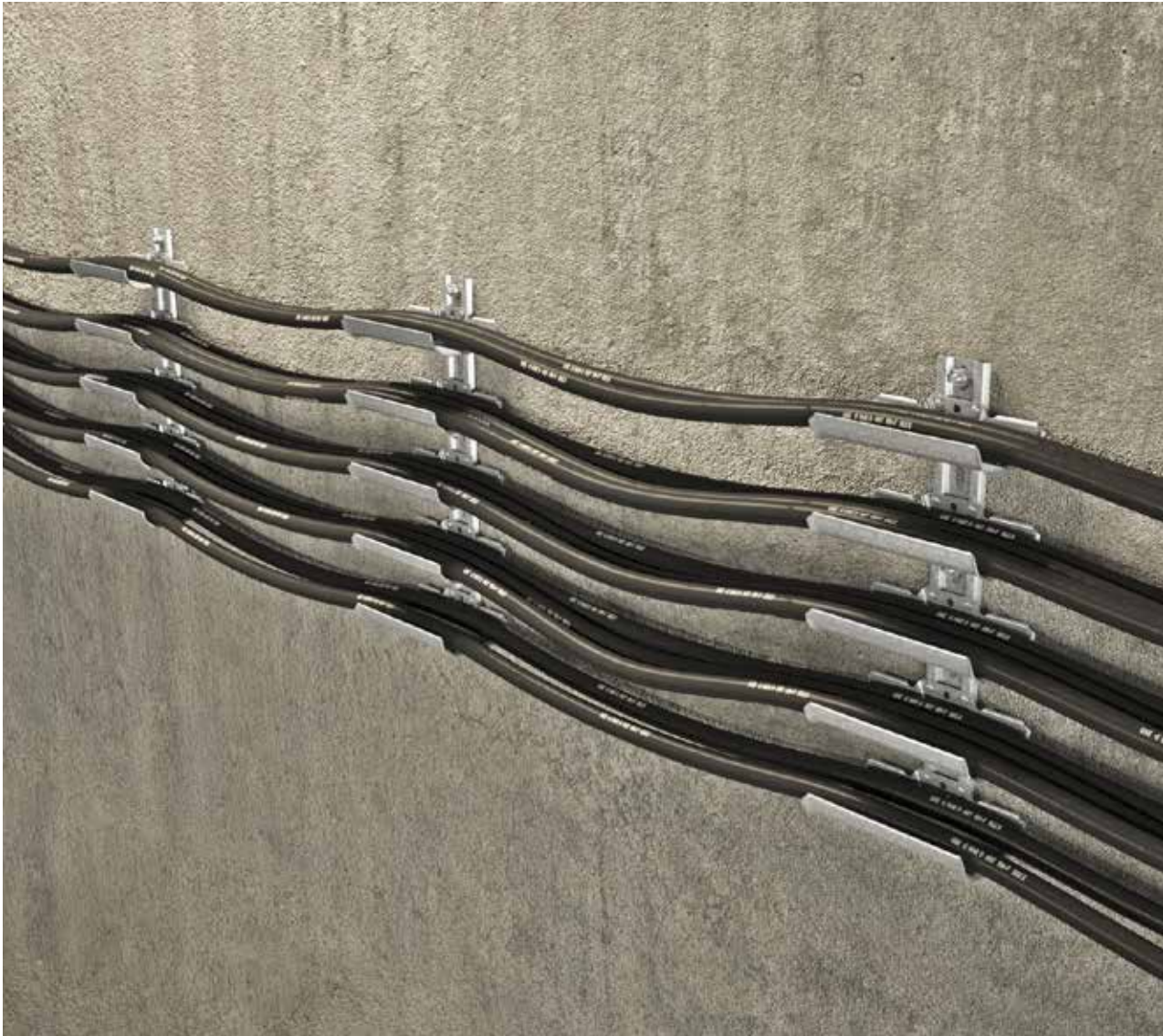

Cable support brackets are used for quick and easy routing of cables in areas where conventional cable support systems cannot be installed due to lack of space. The cable support brackets have a large load-bearing surface and rounded outer edges to protect the cables.

Mounting aid

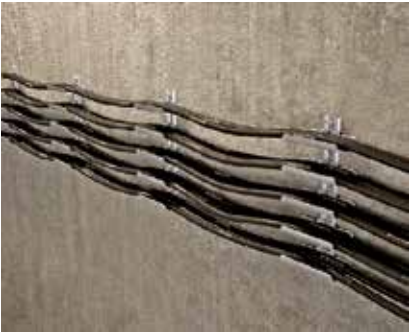

Factory pre-assembled cable carrier trays help in a fast installation.



Cable carrier trays for single installation to serve a flexible connection of cables.



System description



The beam clamp systems with reduced installation times and work are a clear argument for the use of this system in all areas of professional electrical installations. Beam clamps can be attached without difficult, often unpermitted drilling. The load range runs from light-duty clamping angles to heavy-duty chuck jaws.

The clamping lugs/clamping angles, type KL, KWH and KWS, and the chuck jaws, type TKH and TKS, permit excellent connections without drilling or welding, on account of the perfect matching to additional system articles.

Installation principle

- 1 Chuck jaw, heavy duty
- 2 Chuck jaw, light duty
- 3 Profile rail
- 4 Clamping angle
- 5 Beam clamp, horizontal
- 6 Beam clamp, vertical

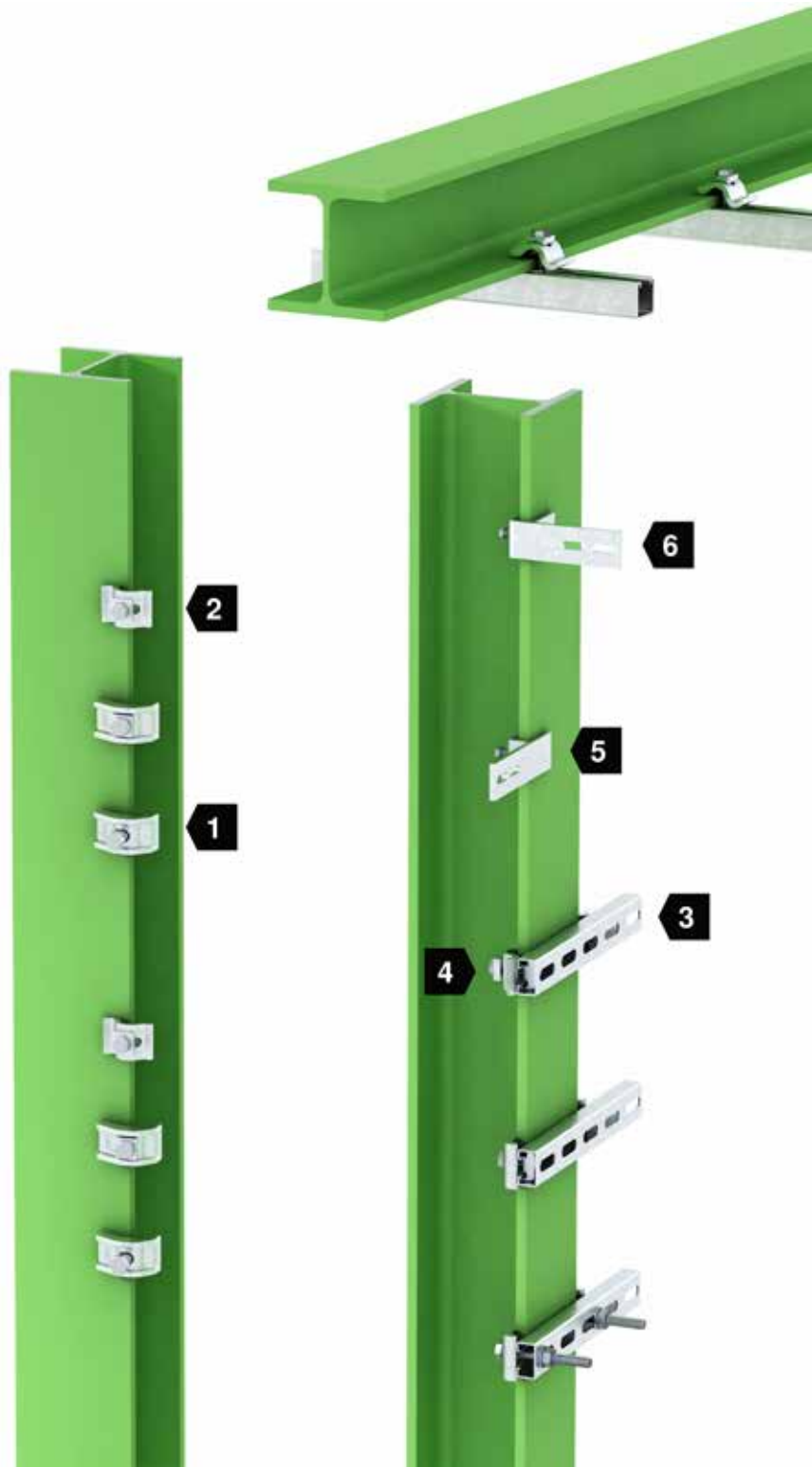

Mounting aid

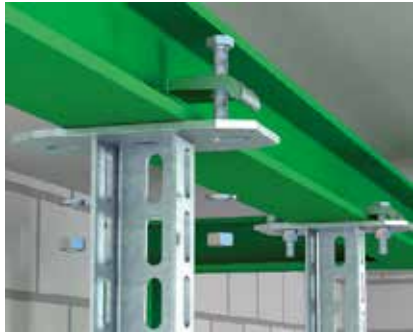

Application on horizontal steel girder
Clamp fastenings using clamping angles and chuck jaws on horizontal steel girders.



Application on sloping steel girder
Clamp fastenings using clamping angles and chuck jaws on sloping steel girders.



Steel clamping, C profile rail
Fastening of a C profile, type MS 4022 or MS 5030, to steel girder using clamping angles, type KWS.



Direct girder clamping
Direct girder clamping of an I suspended support using chuck jaw (heavy duty), type TKS-S-30. Route along steel girder.



Clamp fastening with additional C profile
Use of an additional C profile rail, type MS, for wider steel girders. Route along steel girder.



Clamping transverse to steel girder
Use with two C profile rails for route mounting transverse to the steel girder.



Cantilever beam on steel
Mounting of U support as cantilever beam on steel girder. Fastening with clamping angles or chuck jaws depending on load. Fastening with spacers, type DSK.



Cantilever beam with suspended support
Cantilever beams made of U support construction clamped to steel girder for mounting suspended supports.



Clamp fastening on vertical steel girder
Mounting of the adapter plate, type KA-AW, on the vertical steel girder using clamping angles or chuck jaws. Wall brackets of type AW are fastened to the adapter plate, using the hexagon head screw, type SKS 12x40 GF.



45° adapter plate, steel clamping

Mounting of the 45° adapter plate, type KA-E 45, on the steel girder using clamping angles or chuck jaws. For additional support of routes in angles and at room corners.



Vertical clamp fastening

Clamp fastening of a heavy-duty bracket with clamping angles or chuck jaws on a vertical steel girder.



Vertical clamp fastening

Mounting of a mesh cable tray vertically on a steel girder, mounting with a fixing clamp BFK and hold-down clamp GKS 50.



Horizontal clamp fastening

Mounting of AZ small duct using BFK fixing clamp in a longitudinal direction on the steel girder. Maximum cable tray width 100 mm.



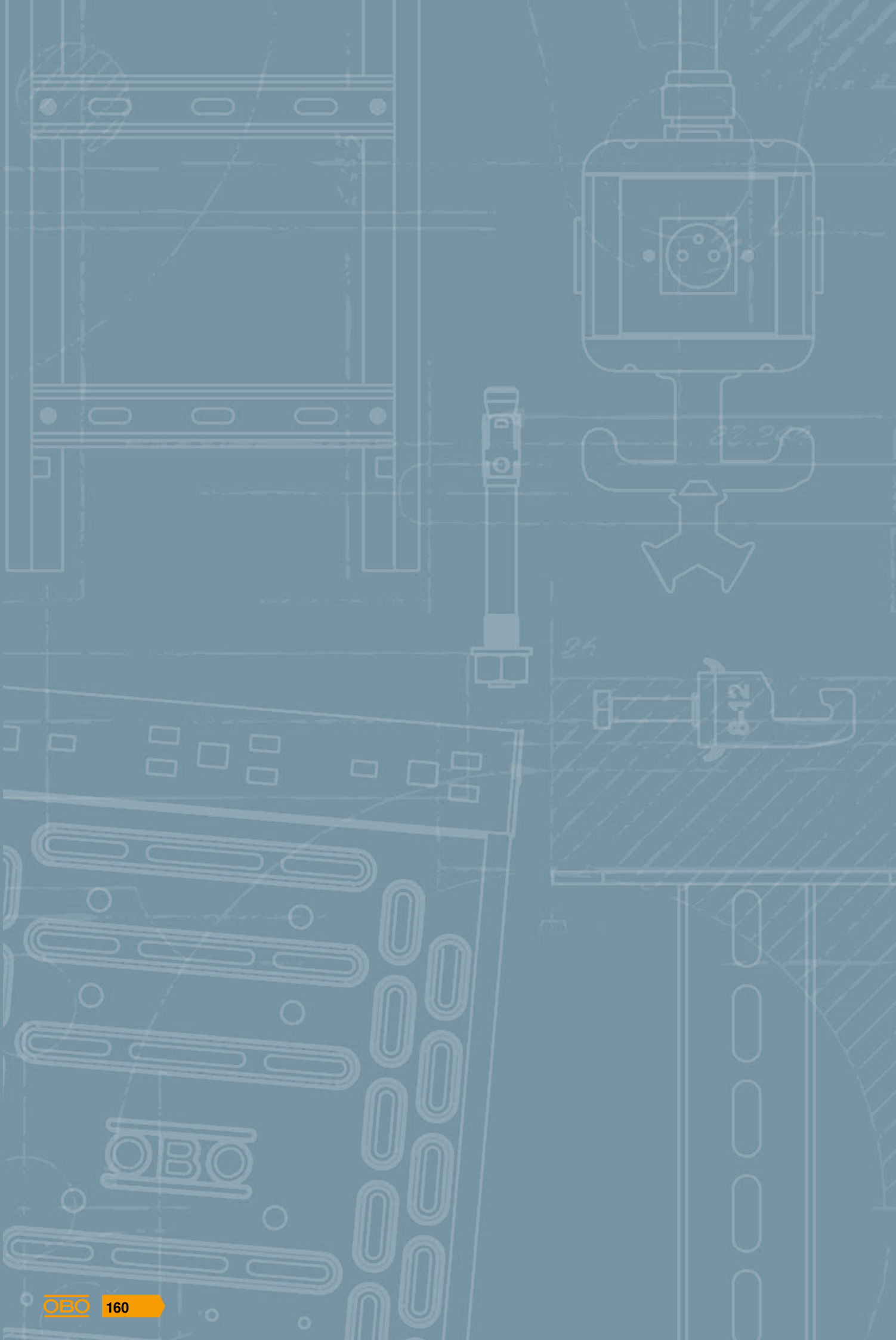

Power supply units



Power supply units VH/VHF

162



Industrial service poles

168



System description



Suspended energy distributors for workplaces and machines in industry, the trades and in training areas. The power supply units can be positioned freely in the room. The supply comes from the ceiling. They can be equipped flexibly from power, data and media technology through to work media such as compressed air.



Robust and trusted

The housings of the power supply units are made of highly resistant polyamide and offer installation space for 4 to 8 installation devices. This means that power supply units provide connections for work media directly and safely at the workplace.

Cables are inserted in the power supply units via penetration sleeves. Integrated strain relief options in the housing ensure standardised installation. The suspension of the power supply units takes place in a fixed manner with a chain, with a spring or ergonomically with the positioner.



Modul 45® sockets

Up to two Modul 45® sockets can be installed on each connection side of the power supply unit. Different circuits can be installed in the housing. The entire product range of international sockets is available.



Compressed air

The compressed air connection to the power supply unit is designed for compressed air hoses 13 x 3.5 mm. The hose connection is fixed and locked using a hose clip. The power supply unit is equipped with a 2-way distributor 1/2".



CEE connection unit

CEE 16 A and CEE 32 A sockets can be installed in the power supply units.



Data technology and multimedia

The entire Modul 45® range of data and multimedia technology is suitable for the network connection of machines and systems and in seminar and training rooms.



Mounting aid



Installation with knotted chain

Mounting with a knotted chain is a rigid installation and does not require any additional cable reserves. Shorten the knotted chain to the required length and fasten it using the pre-mounted eyelet on the housing cover.



VH/VHF device installation – extension accessories

Fasten extension accessories for the 38 x 38 mm fastening system to the appropriate cover plate using the screws supplied. After connecting the cable, place the cover plate on the housing and fix it using fastening screws.



VH/VHF device installation – CEE

The connection of cables to a CEE connection unit must be carried out using a pre-mounted cover plate. During device mounting, the cover plate is fastened using 4 fastening screws.



VHF device installation – IP44 socket

The IP44 socket is inserted and locked into the appropriate cover plate. After connecting the cable, place the cover plate on the housing and fix it using screws.



Installation with tension spring

With additional installations with a tension spring, always ensure flexible cable routing. The tension spring is usually used with compressed air for VH units and inserted directly in the fastening seat.



Cable entry

Cables are inserted using the pre-punched openings in the housing cover. Correct strain relief is achieved using the cable terminals integrated in the housing.



Compressed air connection

The compressed air connection is designed for compressed air hoses 13 x 3.5 mm. The hose connection is fixed and locked using a hose clip.



VH device installation – Modul 45°

The Modul 45° devices are inserted and locked into the appropriate cover plate. After connecting the cable, place the cover plate on the housing and fix it using 2 screws.



VH device installation – support ring (EKR)

After cable connection, accessories with a support ring are screwed directly into the housing. The cover plate is fastened by mounting the central plate.



VHF device installation – protection device

In the first step, the appropriate support is pre-mounted using a PE terminal strip or N and PE terminal strip in the upper half of the housing. For this, the inner part of the fastening tracks must be completely removed.



VHF device installation – protection device

In the second step, the support bracket for the power supply unit is mounted in the lower half of the housing. Then the devices are connected and installed.



VHF device installation – protection device

In the third step, the transparent cover is placed on the cover plate and fastened with 4 screws. After that, mount the cover plate onto the equipped housing side using 4 screws.





Power supply unit with increased IP protection

The VHF8 power supply unit is specially designed for use in moist and wet areas. In the unused state, the housing equipment and the devices offer a protection level of IP44 (protected against spray water).

Through the installation of up to 4-pole protection devices, workstations can be protected appropriately and in a decentralised manner.



Pre-terminated power supply units

For a quick and easy ordering process, pre-terminated power supply units are available for standard applications, with and without compressed air connections. The sockets are already prewired and tested in the housing. The cable connection is quick and easy and uses prepared screw terminals.

VH and VHF empty housing – freely configurable

**Equipment VH4 and VH8**

The VHF power supply units are available as an empty housing for 4 (type VH4) or 8 (type VH8) connection sides for installation devices. The empty housings are offered with and without compressed air connections.

The standardised cover plates can be used in VH4 and VH8 and allow the installation of Modul 45®, extension sockets with hinged lids, standard installation devices (with 50 mm central plate) and CEE connection units.

**Equipment VHF**

The VHF power supply units are available as an empty housing for 8 installation devices. The empty housings are offered in versions with and without compressed-air connections.

Special cover plates for increased IP protection are available for the VHF. The special cover plates for VHF allow the installation of extension sockets with hinged lids, CEE connection units and decentral protection devices.



System description



Our industrial service poles combine power, data and compressed air connections in a compact and sturdy manner. This makes changes of location, for example when adjusting production processes, particularly quick

and easy. Thanks to the modular set-up, it is easy to equip the service pole according to the new requirements. The ISS basic profile is fully compatible with all known item MB Building Kit Systems.



ISS basic profile



1 System opening

Device installation

ISS industrial poles can be equipped with practically standard systems. The 76.5 mm-wide system opening is ready for the installation of:

- Switching and connection devices
- CEE connection units 16 A/32 A
- Data technology
- Series-mounted devices

2 Flexible use

In order to be able to install cables and wires of different voltage levels, it is possible to divide the installation space with a partition.

3 Channel rail

Installation

The channel rail enables, using item slot nuts, the attachment of:

- Monitors
- Keyboards
- Reading, transmitting and receiving equipment
- Fixed or flexible pipelines for compressed air or gases

4 Compressed air tap

Tap to take off compressed air from the pole profile. The compressed air tap can be mounted onto the pole profile using slot nuts and fastening screws.



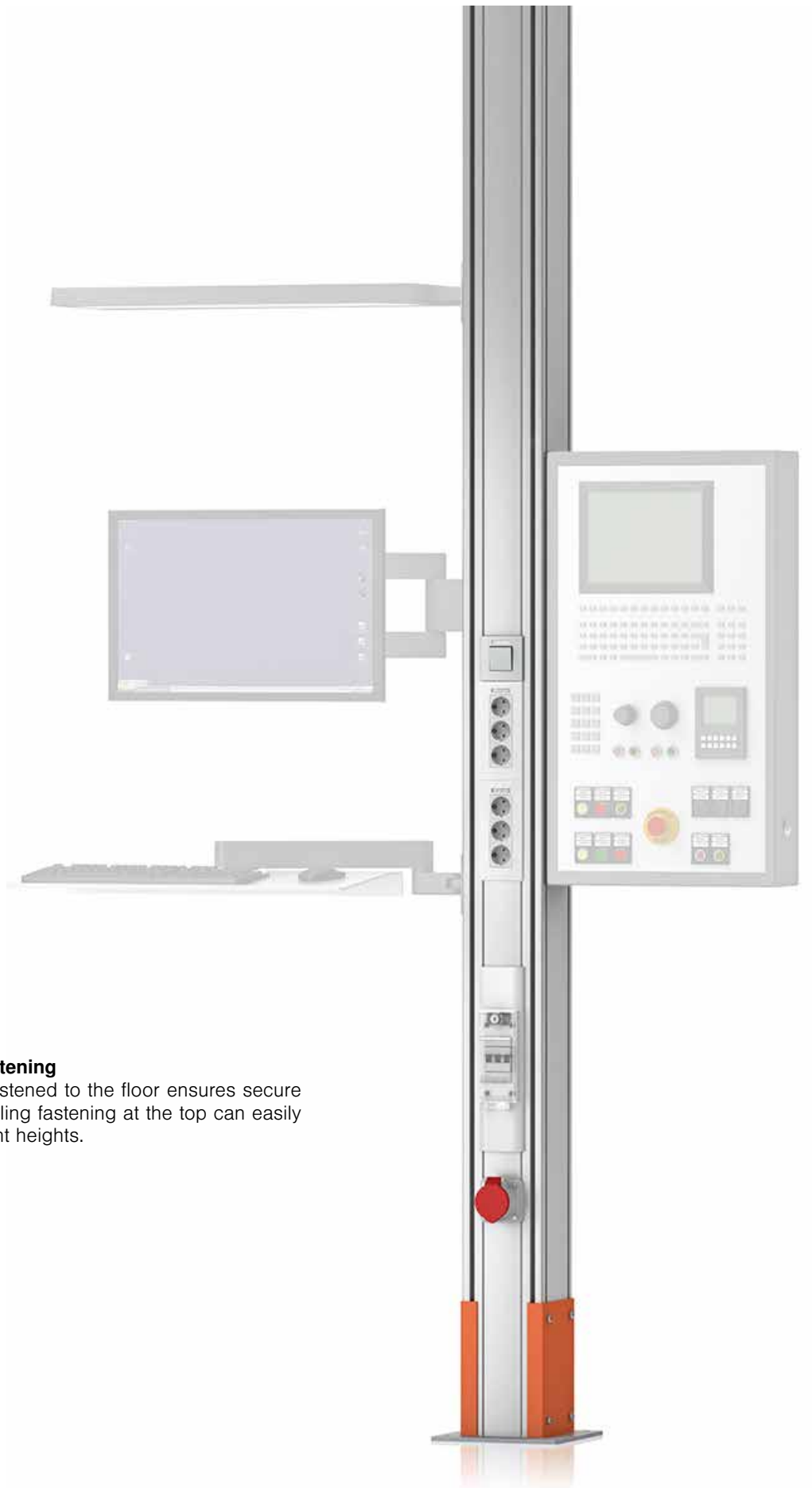

Stand and ceiling fastening

A solid stand to be fastened to the floor ensures secure mounting. A solid ceiling fastening at the top can easily be adjusted to different heights.



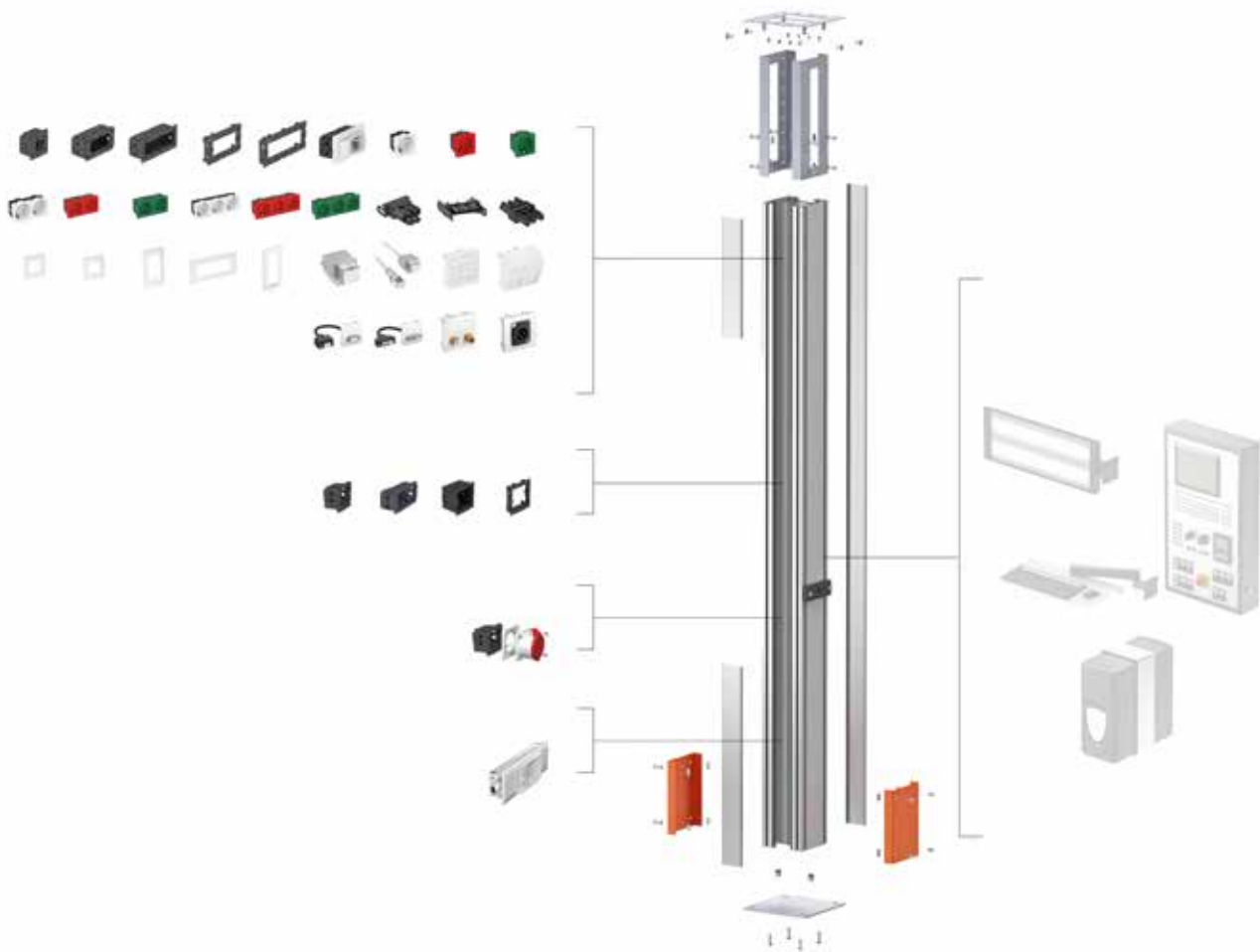

Mounting in the system opening

The 76.5 mm system opening accommodates accessory mounting sockets of the series 71GD... In addition to standard systems from other manufacturers, the complete OBO product range stands ready for installation of:

- Switching and connection devices
- CEE connection units
- 16 A/32 A
- Data technology from all manufacturers
- Multimedia (audio, video, VGA, XLR, etc.)
- IKR4 and IKR6 series-mounted devices
- Pre-terminated “plug and play” solutions with ready-to-connect connection cables

Mounting in the channel rail

The service pole has one channel rail to every side, aligned to the established item grid dimensions. This means, there are no limitations with regards to adapting all kinds of different expansion elements and integrating the poles into machine and plant constructions. The channel rail provides the option to attach:

- Monitors
- Keyboards
- Reading, transmitting and receiving equipment
- Fixed or flexible pipelines for compressed air or gases





Connection to cable support systems

Using the appropriate brackets, cable ladder and cable tray systems can be attached to the pole easily and securely.

Connection to a walkable cable tray

With our walkable cable tray systems, power and data can be fed into service poles.



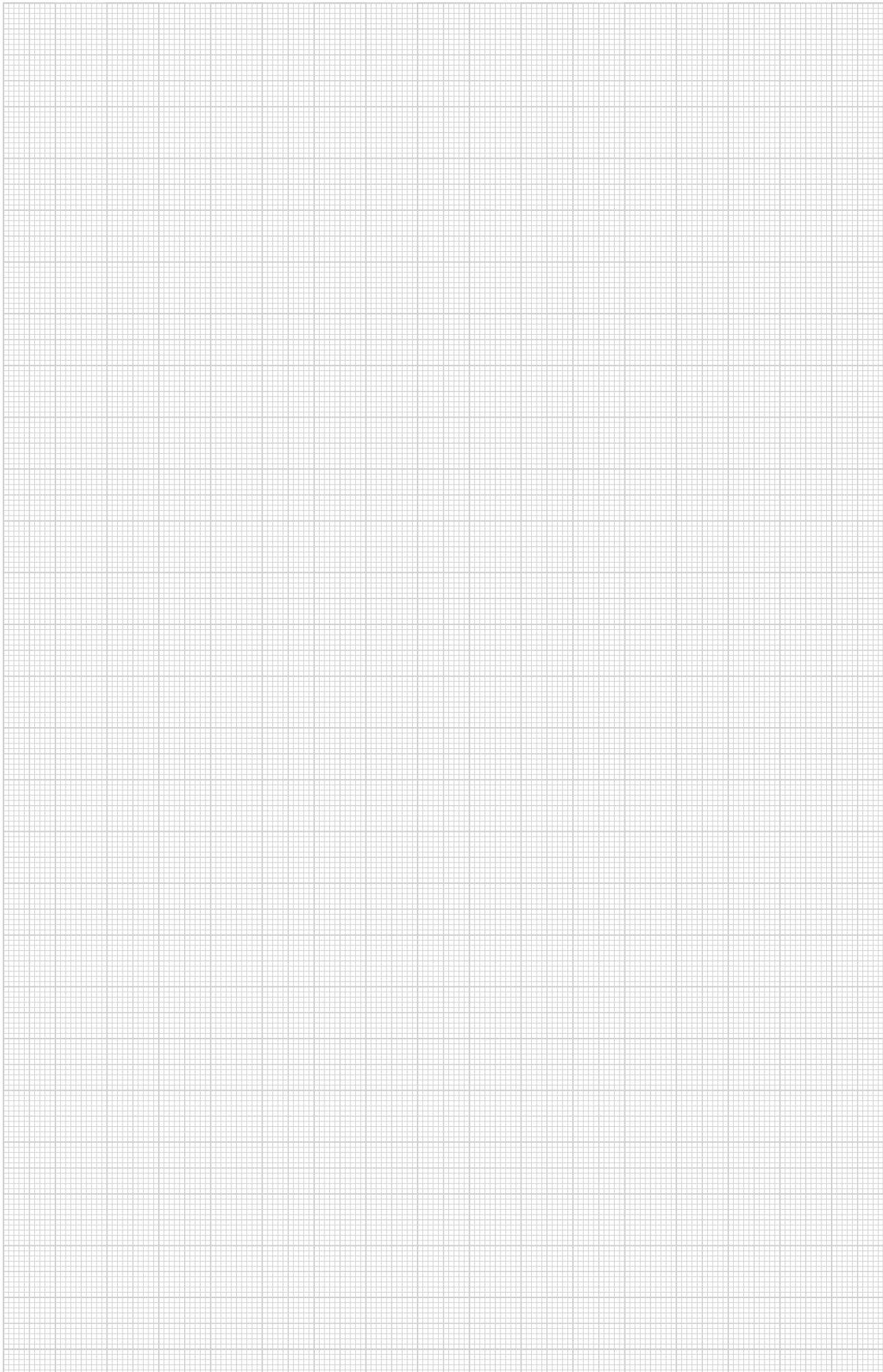

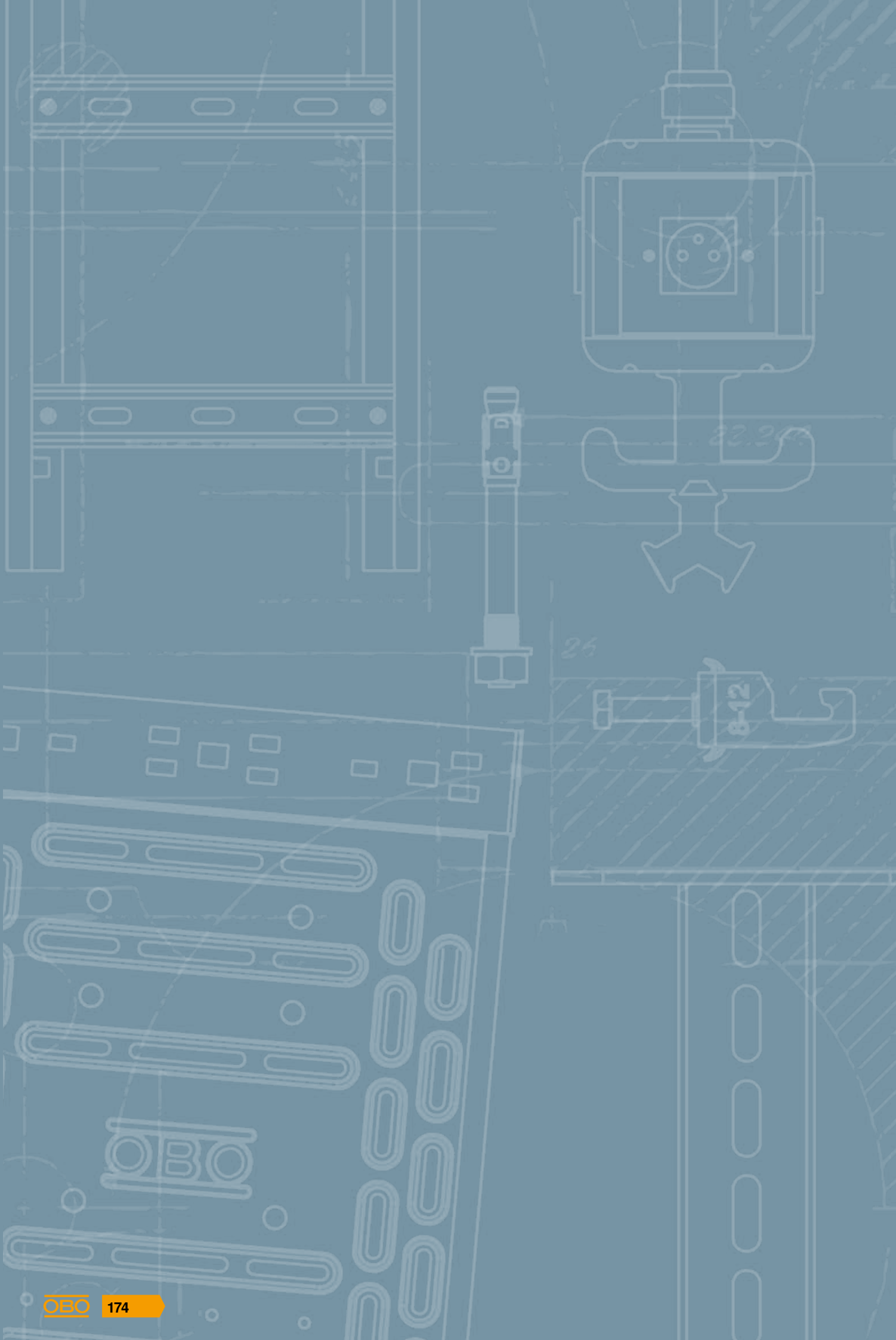

Wiring ducts and trunking



Wiring ducts and trunking

176



System description



An exceptionally large range of products in the usual high quality: Wiring ducts and trunking ensures tidy wiring in a switchgear cabinet. All the duct is made from lead-free material. And, for optimum safety, a selection of halogen-free duct is available from our range.

For professional wiring installation, Wiring ducts and trunking in dimensions between 15 x 15 mm and 100 x 100 mm is available. A soft, burr-free slot and rounded tabs make mounting easier and also prevent injuries. Upon request we can also offer special designs.

Precise measurements and tested quality

The LK4 and LK4/N as well as the LKV and LKV/N duct systems have exactly predetermined points for easy breaking-out of the side retainers. All types have, depending on their size, single or dual-track perforation to their base. Tapering in the side slots of the LK4/N and LKV/N types prevents the cables from falling out.

The Wiring ducts and trunking is VDE-tested and UL-listed (UL File E301798).

LK4 and LK4/N

OBO offers the LK4 Wiring ducts and trunking in the measurements from 15 x 15 mm to 80 x 120 mm. Precise processing enables simple attaching and detaching of the cover while, at the same time, ensuring a firm fit.

LKV and LKV/N

The special cover contour also guarantees a perfect fit on the LKV Wiring ducts and trunking. In the dimensions from 25 x 25 mm to 100 x 100 mm (DIN EN 50085- 2-3), it caters for any size requirement.

LKV/H

The LKV/H Wiring ducts and trunking is halogen-free and available in eight different sizes from 50 x 37.5 mm to 75 x 125 mm.

Upon request we can also offer customised solutions:

- Starting dimension of the base perforation can be adjusted variably
- Available without base perforation
- Special lengths
- Special colours

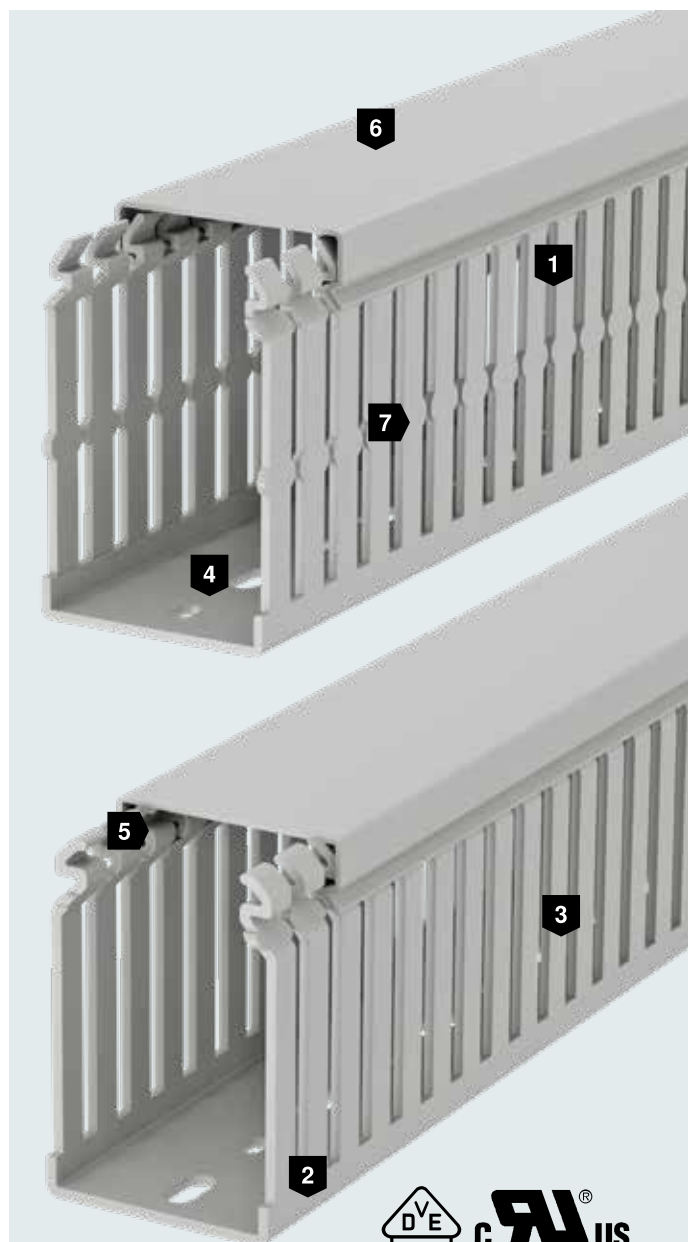

- 1 Stable duct with high-quality thicknesses
- 2 Exact predetermined breaking points in the strut and base area
- 3 Soft, burr-free slot, rounded tabs
- 4 Absolute dimensional accuracy of the side perforation and base perforation
- 5 Cut edges rounded and deburred in the closing area
- 6 Secure positioning of the covers through optimum closing contours
- 7 Wire retaining nose allows wiring without wire retaining clamp



Mounting aid

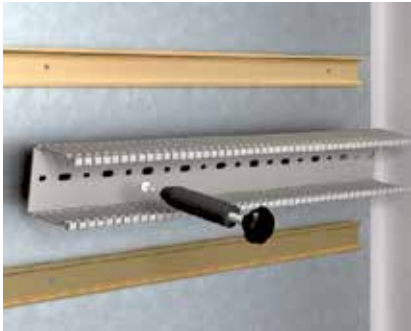

Mounting of the Wiring ducts and trunking

The VK Wiring ducts and trunking is fastened to the mounting plate of the switching cabinet using spreading rivets. The spreading rivets are installed using the plastic rivet tool.



Break-out of retainers

The retainers are bent outwards. When a bend angle of approx. 70–80° is exceeded, they break.



Release pliers

The side retainers can be removed down to the base of the duct using the release pliers. When the side retainers have been broken out, there is no loss in volume in the transition area to the next duct piece.

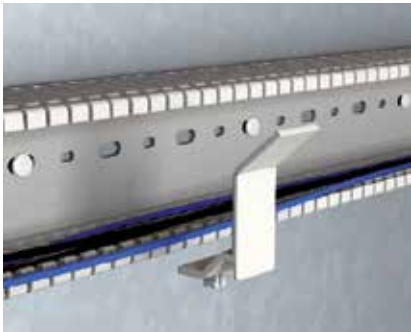

Wire retainers

The wire retainers can be adjusted according to the duct width. To do this, simply break off the wire retainer at the predetermined breaking points. This means that just one wire retainer is necessary for any duct width.



Wire retainer mounting

The wire retainer is inserted into the side slot of the VK Wiring ducts and trunking. This simplifies cable installation and keeps the cables in place in the VK Wiring ducts and trunking. It also guarantees easy attachment of the cover. If installations are required at a later date, then, when the cover is removed, the cables are held in the duct and do not fall out.



Wire holding lugs

In the N versions, there is a holding lug on the side retainer, allowing fixing of the cables in the VK Wiring ducts and trunking.



Cover contour LK4

True to size processing enables easy mounting and removal of the cover, despite a firm cover fit.



Cover contour LKV

The special cover contour also guarantees a perfect fit on the LKV Wiring ducts and trunking.

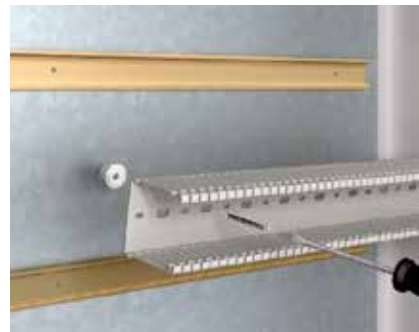

Mounting of spacers

Through the mounting on spacers, it is possible to install the VK Wiring ducts and trunking at a distance to the mounting plate.

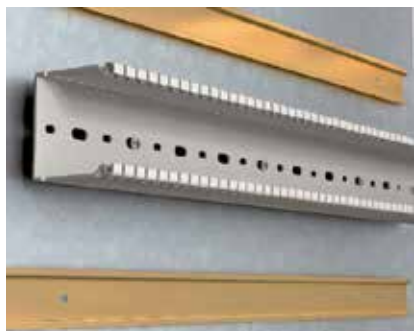

Spacer mounting

The spacers can be connected one on top of the other to allow greater distance to the mounting plate. This allows a certain amount of height variation for any cables to be routed behind the VK Wiring ducts and trunking.



Base perforation

Single and dual-track base perforation to DIN 43659 enable precise work.



Hole patterns and dimensions

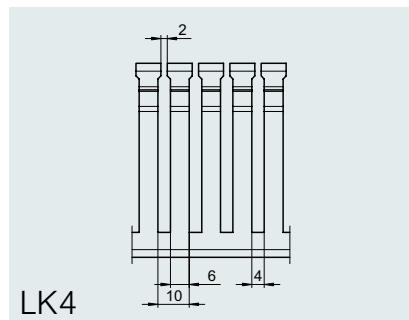
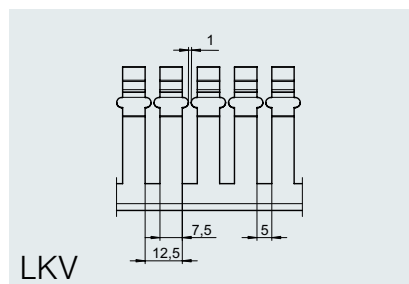
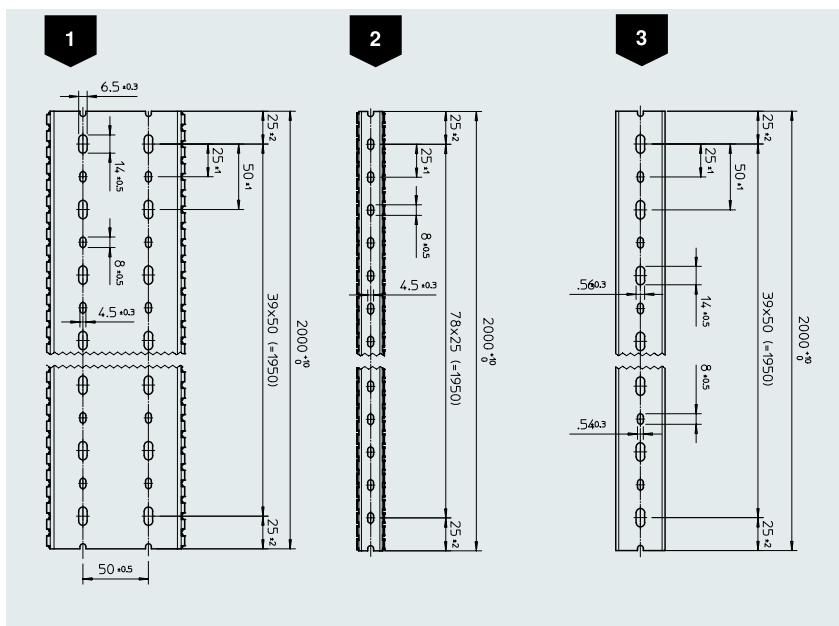

VK and VKH Wiring ducts and trunking always starts and finishes – with regards to one delivery length (2,000 mm) – with half a small fastening hole (4.5 x 8 mm).

LK4/LK4/N	Item no.	Hole pattern
LK4 15015	6178001	2
LK4 30015	6178003	2
LK4 30025	6178005	3
LK4 40025	6178010	3
LK4 40040	6178012	3
LK4 40060	6178014	3
LK4 40080	6178016	1
LK4 40100	6178018	1
LK4 60015	6178026	2
LK4/N 60015	6178201	2
LK4 60025	6178028	3
LK4/N 60025	6178203	3
LK4 60040	6178031	3
LK4/N 60040	6178205	3
LK4 60060	6178033	3
LK4/N 60060	6178207	3
LK4 60080	6178035	1
LK4/N 60080	6178209	1
LK4 60100	6178037	1
LK4/N 60100	6178211	1
LK4 60120	6178039	1
LK4/N 60120	6178213	1

LK4/LK4/N	Item no.	Hole pattern
LK4 80025	6178050	3
LK4/N 80025	6178225	3
LK4 80040	6178052	3
LK4/N 80040	6178227	3
LK4 80060	6178054	3
LK4/N 80060	6178229	3
LK4 80080	6178056	1
LK4/N 80080	6178231	1
LK4 80100	6178059	1
LK4/N 80100	6178233	1
LK4/N 80120	6178236	1
LK4/N 80120	6178236	1

LKV/H	Item no.	Hole pattern
LKV/H 50037	6178612	2
LKV/H 50050	6178614	2
LKV/H 50075	6178616	2
LKV/H 75037	6178622	2
LKV/H 75050	6178624	2
LKV/H 75075	6178626	1
LKV/H 75100	6178628	1
LKV/H 75125	6178630	1

LKV/LKV/N	Item no.	Hole pattern
LKV 25025	6178302	3
LKV 37025	6178305	3
LKV 37037	6178307	3
LKV 50025	6178310	3
LKV 50037	6178312	3
LKV 50050	6178314	3
LKV 50075	6178316	1

LKV/LKV/N	Item no.	Hole pattern
LKV 75025	6178320	3
LKV/N 75025	6178420	3
LKV 75037	6178322	3
LKV 75037	6178422	3
LKV 75050	6178324	3
LKV/N 75050	6178424	3
LKV 75075	6178326	1
LKV/N 75075	6178426	1
LKV 75100	6178328	1
LKV/N 75100	6178428	1
LKV 75125	6178330	1
LKV/N 75125	6178430	1
LKV 10037	6178334	3
LKV/N 10037	6178435	3
LKV 10050	6178336	3
LKV/N 10050	6178437	3
LKV 10075	6178338	1
LKV/N 10075	6178439	1
LKV 100100	6178341	1

Dimensions, LK4 Wiring ducts and trunking

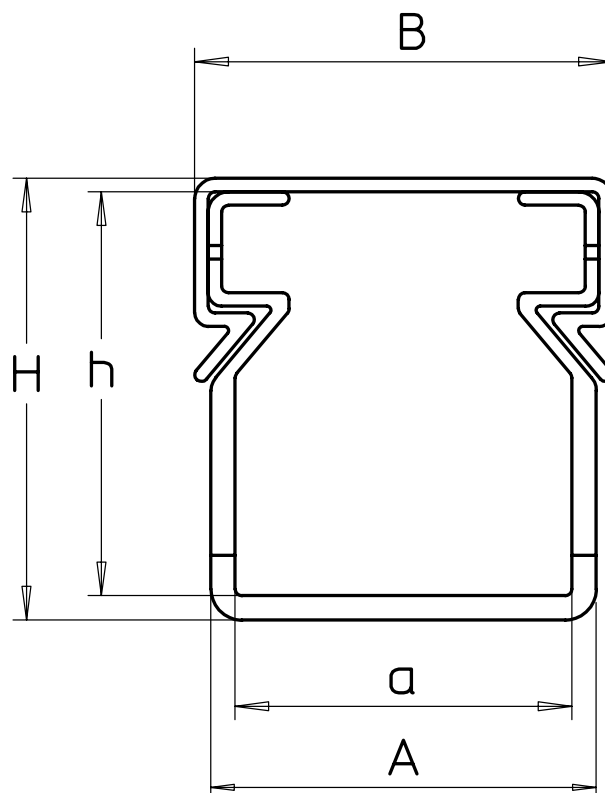

Dimensions LK4

Item no.	Type	Item no.	Type	Dimension a mm	Dimension A mm	Dimension B mm	Dimension h mm	Dimension H mm
6178001	LK4 15015			15	17	20	15	17
6178003	LK4 30015			15	17.8	20	30	32.4
6178005	LK4 30025			25	28.6	31	30	32.8
6178010	LK4 40025			25	28.6	31	40	42.8
6178012	LK4 40040			40	43.6	46.2	40	43
6178014	LK4 40060			60	64	66.4	40	43.2
6178016	LK4 40080			80	84	87	40	43.5
6178018	LK4 40100			100	104	107.4	40	43.7
6178026	LK4 60015	6178201	LK4 N 60015	15	18.6	20	60	62.8
6178028	LK4 60025	6178203	LK4 N 60025	25	29	31	60	63
6178031	LK4 60040	6178205	LK4 N 60040	40	44	46.2	60	63
6178033	LK4 60060	6178207	LK4 N 60060	60	64	66.4	60	63.2
6178035	LK4 60080	6178209	LK4 N 60080	80	84.4	87	60	63.7
6178037	LK4 60100	6178211	LK4 N 60100	100	104.6	107.4	60	64
6178039	LK4 60120	6178213	LK4 N 60120	120	124.6	127.8	60	64.2
6178050	LK4 80025	6178225	LK4 N 80025	25	29.4	31	80	83.2
6178052	LK4 80040	6178227	LK4 N 80040	40	44.4	46.2	80	83.3
6178054	LK4 80060	6178229	LK4 N 80060	60	64.4	66.4	80	83.4
6178056	LK4 80080	6178231	LK4 N 80080	80	84.6	87	80	83.9
6178059	LK4 80100	6178233	LK4 N 80100	100	104.8	107.4	80	84.1
6178061	LK4 80120	6178236	LK4 N 80120	120	124.8	127.8	80	84.3



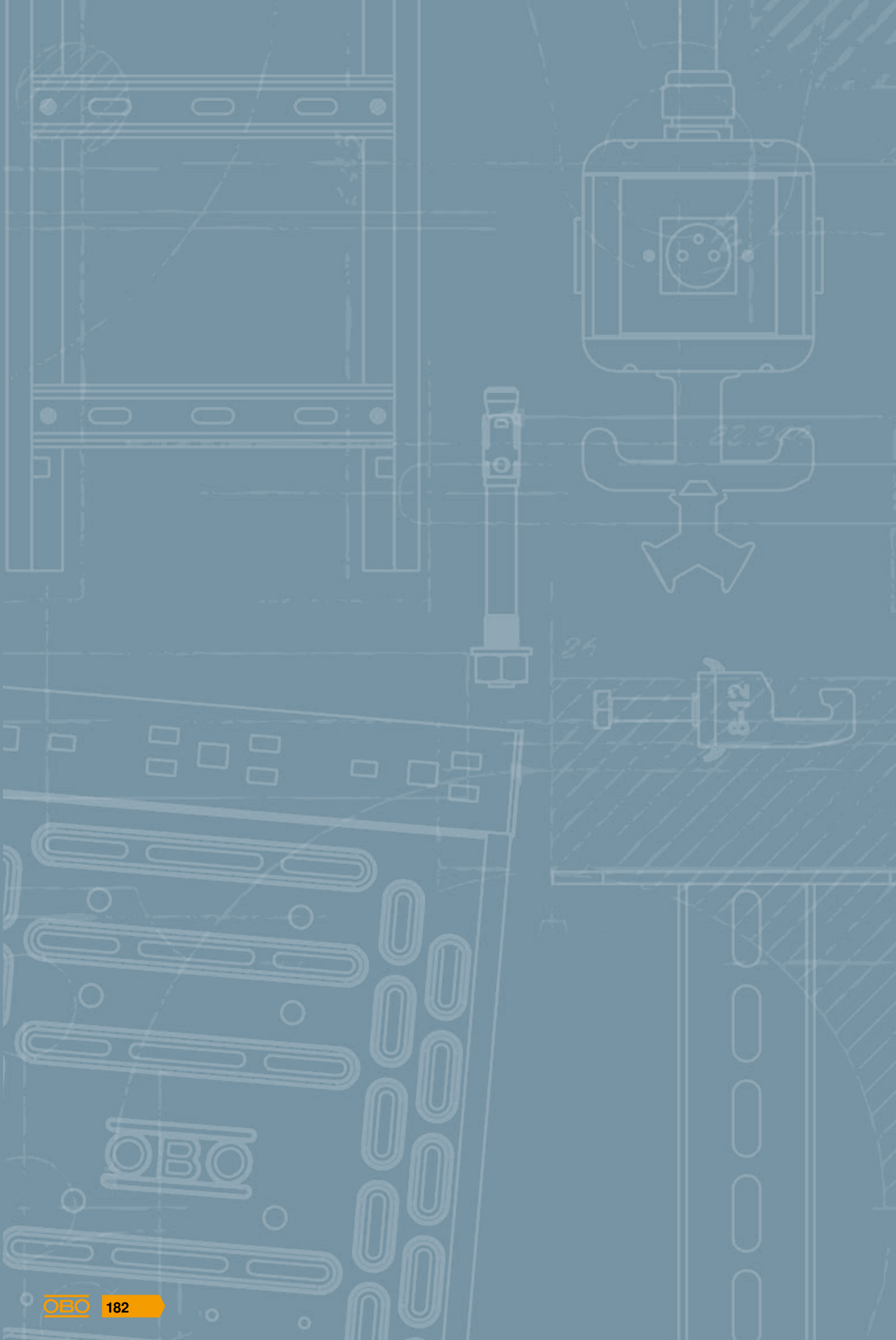

Anchors and fastening systems



General information

184



Metal spreading anchor

186

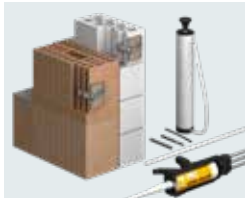

Injection anchor

190



Bolt ties

192

Tightening torques



Different tightening torques apply when mounting a cable support system. Please note that the specified torques are only intended as rough, non-binding guide values (see VDI 2230)!

Tightening torques of bolts with metric thread made of steel

Thread	Grade 5.6	Grade 6.9	Grade 8.8	Grade 10.9	Grade 12.9
M6	3.9 Nm	8.5 Nm	10 Nm	14 Nm	17 Nm
M8	9.8 Nm	21 Nm	25 Nm	35 Nm	41 Nm
M10	19.6 Nm	41 Nm	49 Nm	69 Nm	83 Nm
M12	33.4 Nm	72 Nm	86 Nm	120 Nm	145 Nm
M14	54 Nm	115 Nm	135 Nm	190 Nm	230 Nm
M16	82 Nm	180 Nm	219 Nm	295 Nm	355 Nm
M18	114 Nm	245 Nm	290 Nm	400 Nm	485 Nm
M20	163 Nm	345 Nm	410 Nm	580 Nm	690 Nm

Tightening torques of bolts with metric thread made of stainless steel

Thread	Resistance grade 50	Resistance grade 70	Resistance grade 80
M6	3.8 Nm	8.2 Nm	10.9 Nm
M8	9.2 Nm	19.6 Nm	26.2 Nm
M10	19 Nm	39 Nm	53 Nm
M12	31 Nm	67 Nm	89 Nm
M14	50 Nm	106 Nm	142 Nm
M16	76 Nm	162 Nm	216 Nm
M18	105 Nm	225 Nm	299 Nm
M20	148 Nm	316 Nm	422 Nm

Screw lock



The components listed below are now considered to be ineffective screw locks, as the corresponding standards have been withdrawn. They are therefore not permitted as the sole safety devices for strength classes ≥ 8.8 .

Withdrawn standards:

Spring lock washers (DIN 127, DIN 128 and DIN 6905)
 Wave spring washers (DIN 137 and DIN 6904)
 Toothed discs (DIN 6797)
 Serrated washers (DIN 6798)
 Locking plates (DIN 93, DIN 432 and DIN 463)
 Safety cups (DIN 526)
 Locking nuts (DIN 7967)
 Castle nuts with split pin (DIN 937)

All specified standards have now been withdrawn, however these components can often still be used as “captive prevention”! Captive protection devices prevent a screw connection from being completely unscrewed, but not from loosening.

At OBO Bettermann, individual products, such as hexagonal bolts with washer and nut, continue to be sold as a complete package, as these are used for electrical contact to surrounding metallic components.

Our systems are generally not exposed to dynamic loads that require screw locking.



System description



The majority of metal spreading anchors from OBO Bettermann have a European Technical Assessment ETA. Some versions have shock approval from the Federal Office for Civil Protection in Bern, Switzerland. Most metal spreading anchors have also been tested in terms of fire protection for a fire resistance time of up to 120 minutes. You can find detailed information regarding the permitted loads (also in the event of a fire) and the installation conditions that must be observed in the corresponding approvals.

System benefits:

- Wide range of application areas thanks to a variety of versions, load classes and material qualities
- Quick and easy installation
- High tensile loads and shear loads
- Small edge and axis spacings
- Can be used indoors and outdoors (depending on material)

Mounting aid



Drilling an anchor hole

Drilling of the anchor hole according to the anchor approval information for the drill hole diameter and the drill hole depth.



Blowing out of the drill hole

Removing dust from the drill hole by blowing it out several times.



Drilling an anchor hole in the ceiling

Drilling of the anchor hole in the ceiling according to the anchor approval information for the drill hole diameter and the drill hole depth.



Blowing out of the drill hole in the ceiling

Removing dust from the drill hole by blowing it out several times.

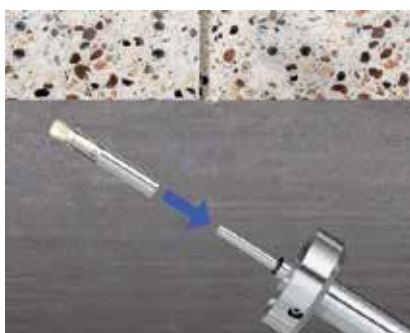

Placing the bolt tie BZ-IG

The bolt tie BZ-IG is placed on the setting tool BZ-IGS. It must be ensured that the thread size of the setting tool fits to the corresponding bolt tie.



Knocking in of the bolt tie BZ-IG

Knocking in of the bolt tie BZ-IG with the appropriate setting tool. Then the component to be mounted can be fastened.



Mounting of threaded rod BZ-IG

Mounting of a threaded rod into the bolt tie BZ-IG. The direct mounting of a component with a hexagonal bolt is also possible.



Application of the torque BZ-IG

Fastening of the threaded rod by tightening the hexagonal nut with the torque specified in the approval.





Nail tie, type N, with threaded connection
Nail tie, type N, with M6 threaded connection, usable in cracked or non-cracked standard concrete C20/25 to C50/60.



Nail tie, type N-K, with drive-in head
Nail tie, type N-K with drive-in head, usable in cracked or non-cracked standard concrete C20/25 to C50/60.



Bolt tie, type BZ
Bolt tie, type BZ, for fastening heavy-duty anchorings in cracked or non-cracked standard concrete C20/25 to C50/60, suitable for push-through mounting, with M8, M10, M12 or M16 thread.



Bolt tie, type BZ-IG
The bolt tie BZ-IG with internal thread is approved for normal drill holes which are not undercut. Within the scope of the European Technical Assessment ETA-99/0010 for cracked and non-cracked concrete, a system comprising nut and washer and a standard threaded rod can be used, as well as hexagonal bolts and countersunk head screws.



Impact tie, type ES
Impact tie, type E, with M6, M8, M10, M12 internal thread. To accept small loads, approved for multiple fixings in cracked and non-cracked concrete of non-load-bearing systems.



High-load anchor, type SZ
High-load anchor, type SZ, with M12 thread connection for fastening components with high loads, approved for cracked and non-cracked standard concrete C20/25 to C50/60.



Hollow core anchor, type Easy
Hollow core anchor, type Easy, with M6, M8, M10 and M12 internal thread, for use in stressed concrete core slab ceilings.

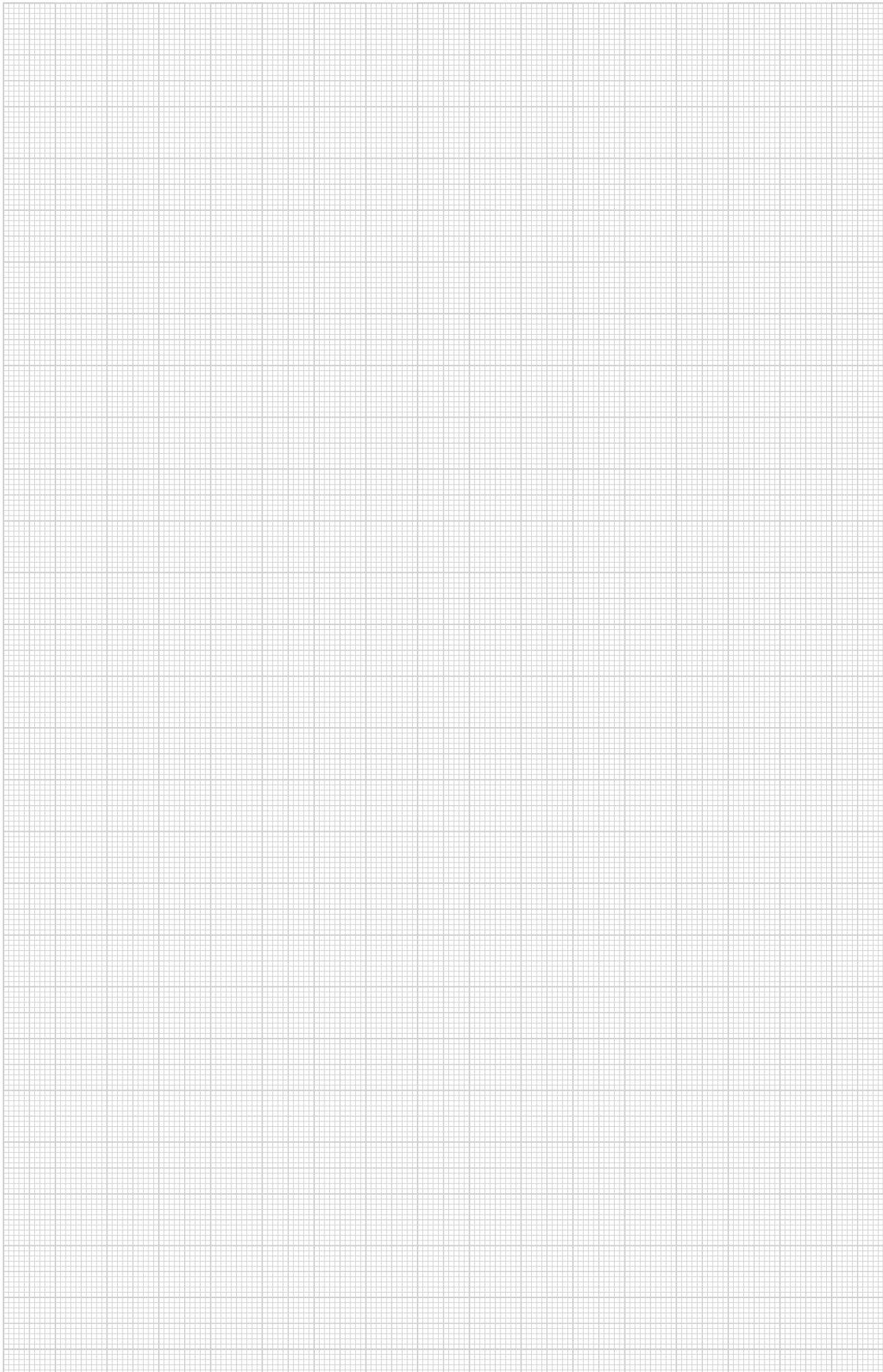

System description



The VMS Plus injection mortar system is particularly suitable for fire-protection fastening in hollow brick, concrete, calcareous limestone, sand-lime brick and masonry. The non-spreading connection is created through the use of the plastic wire sleeve and a threaded anchor rod. The components are tested and approved for a fire resistance period of 90 minutes.

The maximum load capacity depending on the fire resistance period and the fastening substrate is documented accordingly in the available fire protection certificate. Although the load capacity of the injection mortar system is below the load capacity when cold, it is completely sufficient for fireproof fastening of the various components of the different routing types.

System benefits:

- Injection tie tested and approved for fire
- Determined load capacity according to fire resistance period
- Use in calcareous limestone, masonry, hollow brick and sand-lime brick
- Various dimensions for the different routing components and applications
- Proven fastening with plastic wire sieve sleeves

Mounting aid



Drilling
Creation of a drill hole with a suitable diameter.



Cleaning of the drill hole
Blowing out of the drill hole for cleaning with a hand-held blower or compressed air.



Cleaning with steel wire brush
Mechanical cleaning of the drill hole with steel wire brush. The cleaning process with blowing and brushes must be carried out twice.



Application of the injection mortar
Pressing of the injection mortar into the drill hole.



Use in hollow brick
Drill the hole in the hollow brick according to the selected anchor size and then clean it.

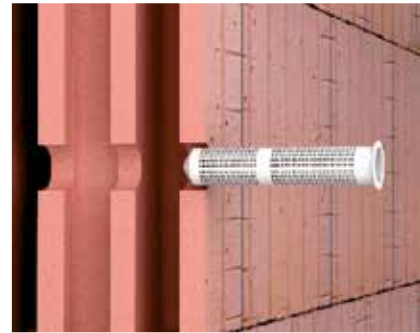

Mounting preparations
Insert the fitting plastic sieve sleeve in the drill hole.



Applying the injection mortar
Press in the injection mortar from the cartridge from the base of the drill hole to the opening. In so doing, draw the point back slowly.

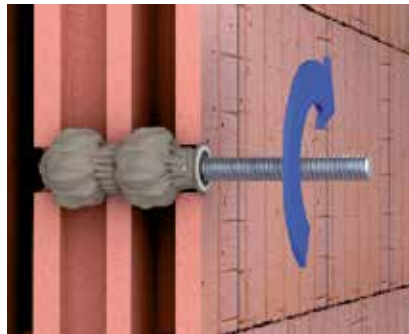

Inserting the anchor rod
Attach the anchor rod in the filled wire sleeve up to the set marking. The mortar pushes through the openings of the wire sleeve, forming a closure.



Mounted component, hollow brick wall
Mounting the component with a washer and nut on a hollow brick wall. Comply with the tightening torque in the approval.

System description

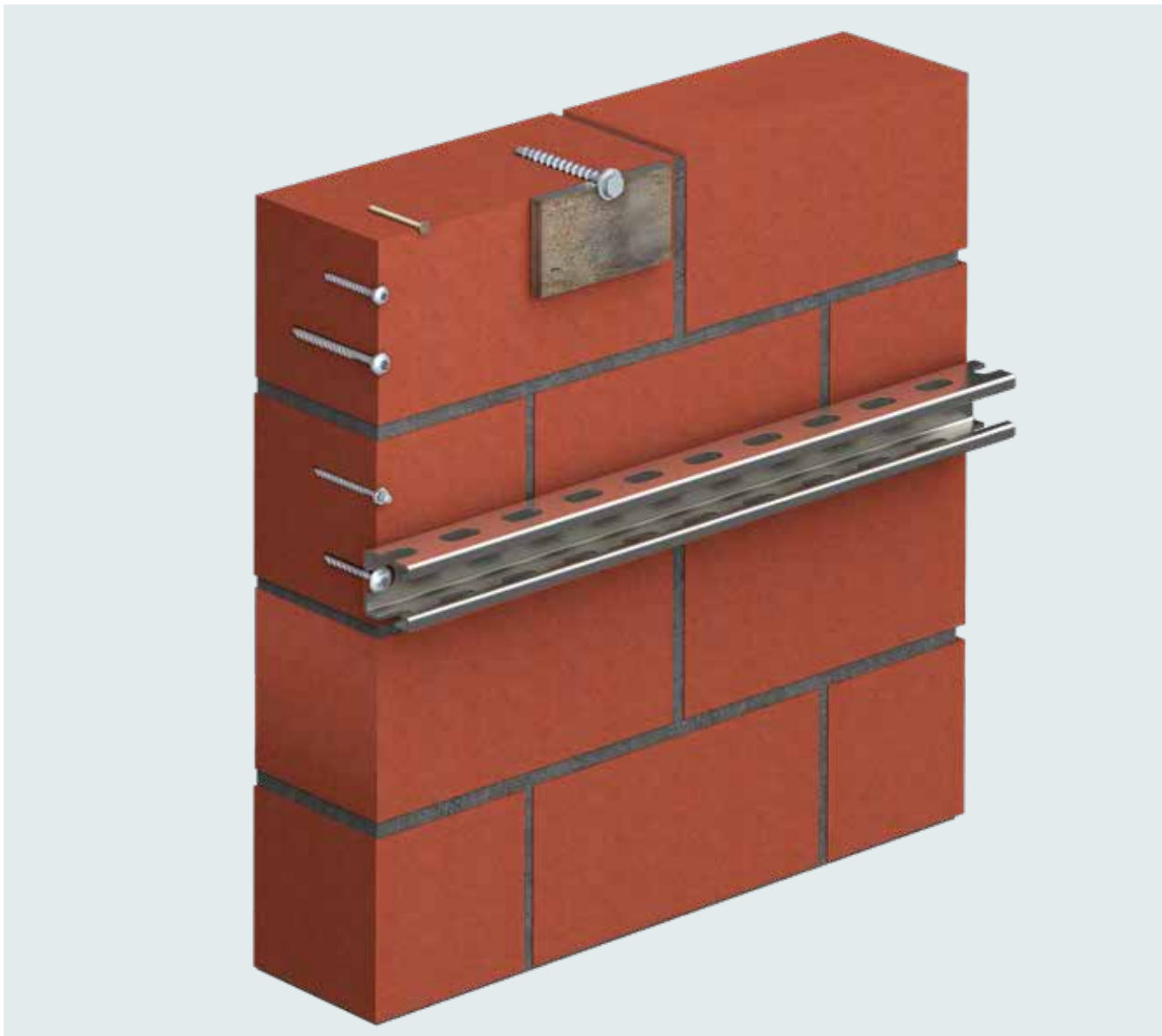

Wedge anchors MMS, MMS-ST and HMS-KS from OBO Bettermann offer optimum fastening options in solid masonry types. The various dimensions and head shapes provide installation options for the different routing components. The wedge anchors are screwed directly into the drill hole. There is no need for an additional anchor. No spreading forces develop and mounting near masonry edges is not required. You can find detailed information in the corresponding approvals.

System benefits:

- Quick and easy installation
- High level of safety
- Can be loaded immediately
- Torque control not required
- Mechanical setting is possible without any problems
- Fire protection-tested

Mounting aid



Drilling an anchor hole

Drilling of the anchor hole according to the anchor approval information for the drill hole diameter and the drill hole depth.



Blowing out of the drill hole

Removing dust from the drill hole by blowing it out several times.



Bolt tie, type MMS-plus bolt tie

MMS-plus with pan head for direct mounting without anchors. Suitable for use in concrete and different types of masonry.



Bolt tie, type MMS-plus

Bolt tie MMS-plus with hexagonal head for direct mounting without additional anchors. Suitable for use in concrete and different types of masonry.



Bolt tie, type MMS-ST

Bolt tie MMS-ST with M6 thread and hexagonal head for direct mounting without additional anchors. Suitable for use in concrete and different types of masonry.



Bolt tie, type HMS

Bolt tie HMS with countersunk cone head for direct mounting without additional anchors. Suitable for use in concrete and different types of masonry.

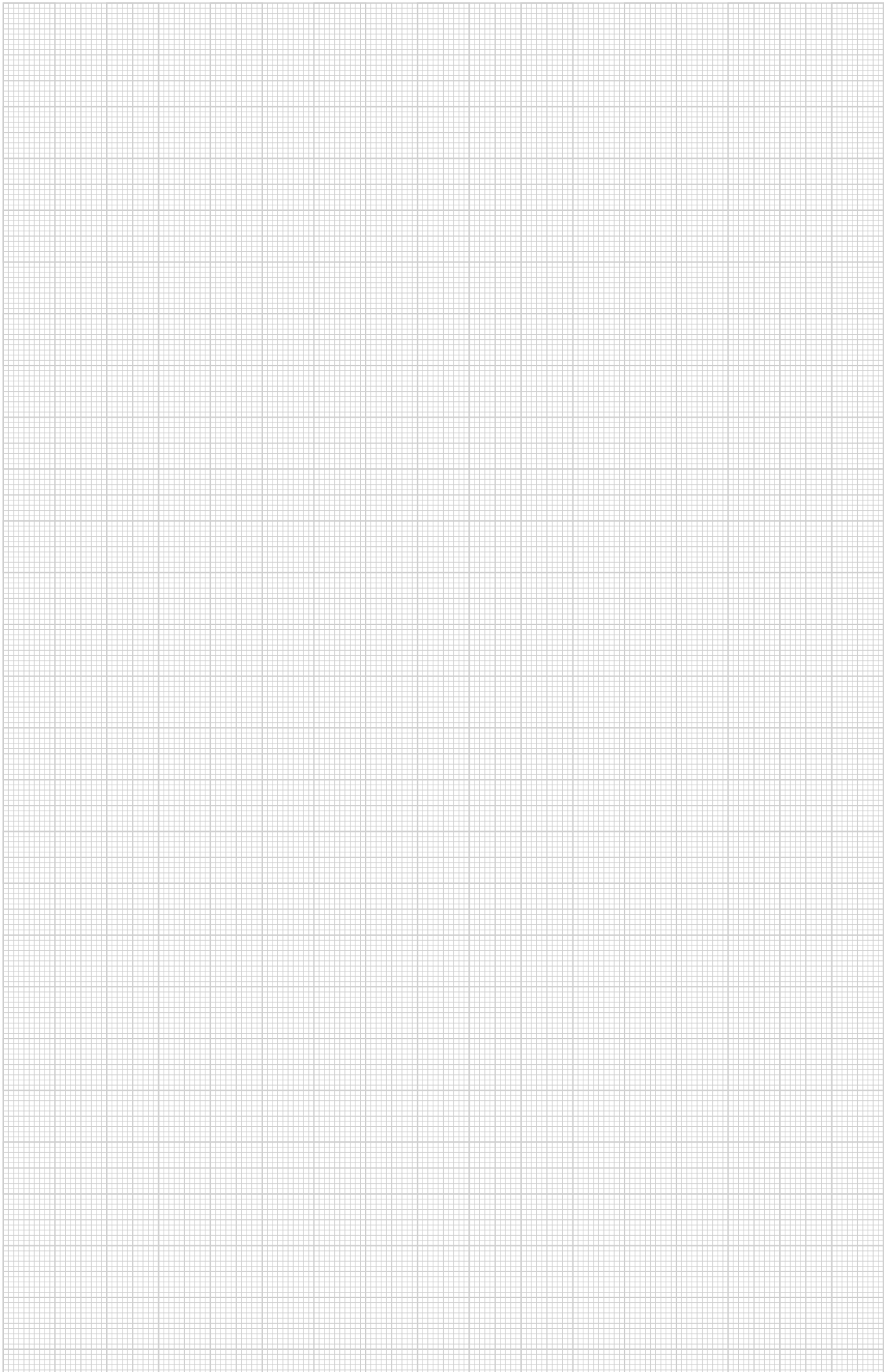

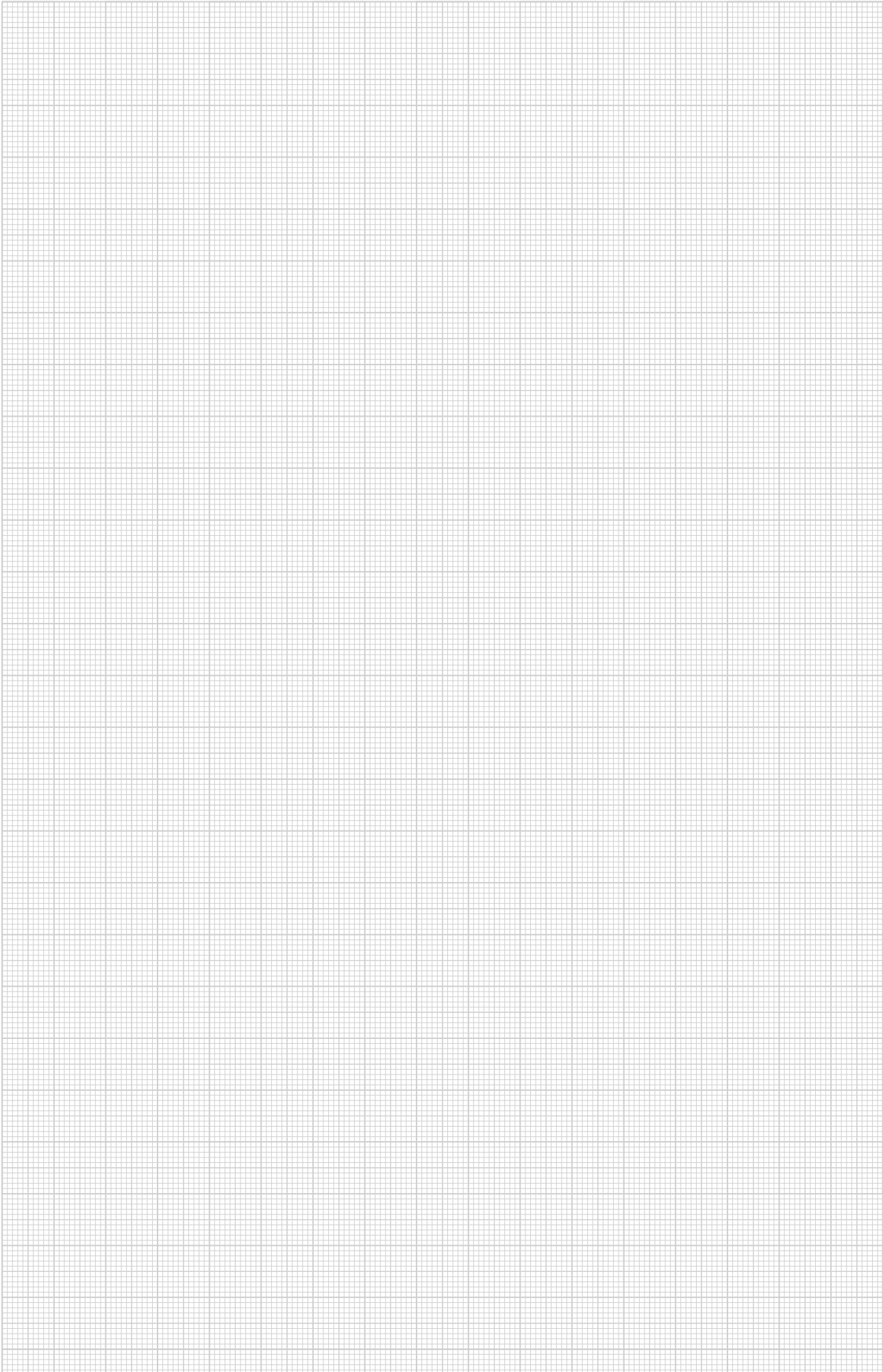

OBO Bettermann Holding GmbH & Co. KG

P.O. Box 1120
58694 Menden
GERMANY

Customer Service

Tel.: +49 (0)23 73 89 - 17 00
Fax: +49 (0)23 73 89 - 12 38
export@obo.de

www.obo-bettermann.com

Building Connections

