

# ISKU





# Isku Active Learning

---

The Isku story	2
Finnish expertise	6
Design	8
Quality and the environment	10
Customer segments	12
Isku Active Learning	14
Focus	16
Share	18
Study	20
Join	22
Highlights   Solutions	24
Highlights   Products	80
Collection	120
Seats and chairs	122
Tables	156
Storage	170
Dividers	180
Accessories and decor	186
Desk and table tops	202
Product index	204

---



ISKU

Since 1928







**Pure materials.  
High quality.  
Finnish design.  
Always responsibly.**

**ISKU  
90**

IskuCenter, Lahti





## Unique Finnish know-how

Isku is a Finnish family business established in 1928. We design and manufacture furniture in Lahti, Finland. Being a Finnish company is both a resource and a source of pride. Our aim is to provide our customers with a sense of success at home, at school, at work, in hospital and care environments as well as in other public facilities. Everything we do is guided by our values: Inspiring, Finnish, Ready to Listen and Evolving. We want to be the most distinguished and recommended service provider company in the interior design sector for our customers and employees alike.

We want to offer our customers the very best and the quickest service. We work responsibly every day and respect customers, partners and employees in everything we do. We are continuously improving our products and production and the competency of our

personnel. This is our key to new innovations.

Our design is inspired by Finnish forests, pure raw materials and environmentally friendly manufacturing methods. All Isku products comply with strictest quality and safety requirements. Every product in our collection has been tested in our testing laboratory. We collaborate with our international design network and follow closely the changes taking place around us. We want to be a pioneer in our field. The keystones of our design are functionality, minimalism, lightness and our Finnish heart. All of Isku's interior design solutions have been designed to stand the test of time and be adaptable to many different purposes and needs. Our diverse collection fosters innovation and leaves room for creativity in all environments.

## At the forefront of changing design

We at Isku want to stay alert, listen to our customers and the environment and keep up with our changing times. We are looking for new product ideas through many channels. We collaborate closely with architects and educational institutions on an international scale, and our extensive freelancer network is actively involved in product development. We organise international design competitions and collaborate closely with several educational institutions in the design field. The majority of new ideas and applications are created through this collaboration. Our new Design Lab workshop in Lahti enables fast-paced experimenting with prototypes.

In the honour of Isku's 90-year-old history, we organised the international Isku90 design competition. The goal of the competition was to discover product families suited for industrial manufacturing and sales in the following categories: Home, Work, Learning and Care Environments. The 130+ innovative competition entries gave us extensive insight in what is happening in the design world right now.

Our products are manufactured in Lahti, Finland. Our factory is a pioneer in technical solutions and the development of manufacturing methods. Our new production lines are globally unique, and the production technology makes it possible to manufacture furniture sustainably and ecologically. The high quality of our products is a combination of advanced manufacturing technology, impeccable handicraft and excellent knowledge of materials.

We combine functionality with our service concept to bring you furniture that's designed to be versatile, adaptable, lightweight and practical and enhances well-being. Our furniture adapts to the needs of the room where they are located, be it a teamwork space or an individualised solution for quiet, independent work. Ecological design is something we highlight from the very beginning of the design process, and we want to operate responsibly and respect our environment. These principles have helped us to lead the way in Finnish design since 1928.

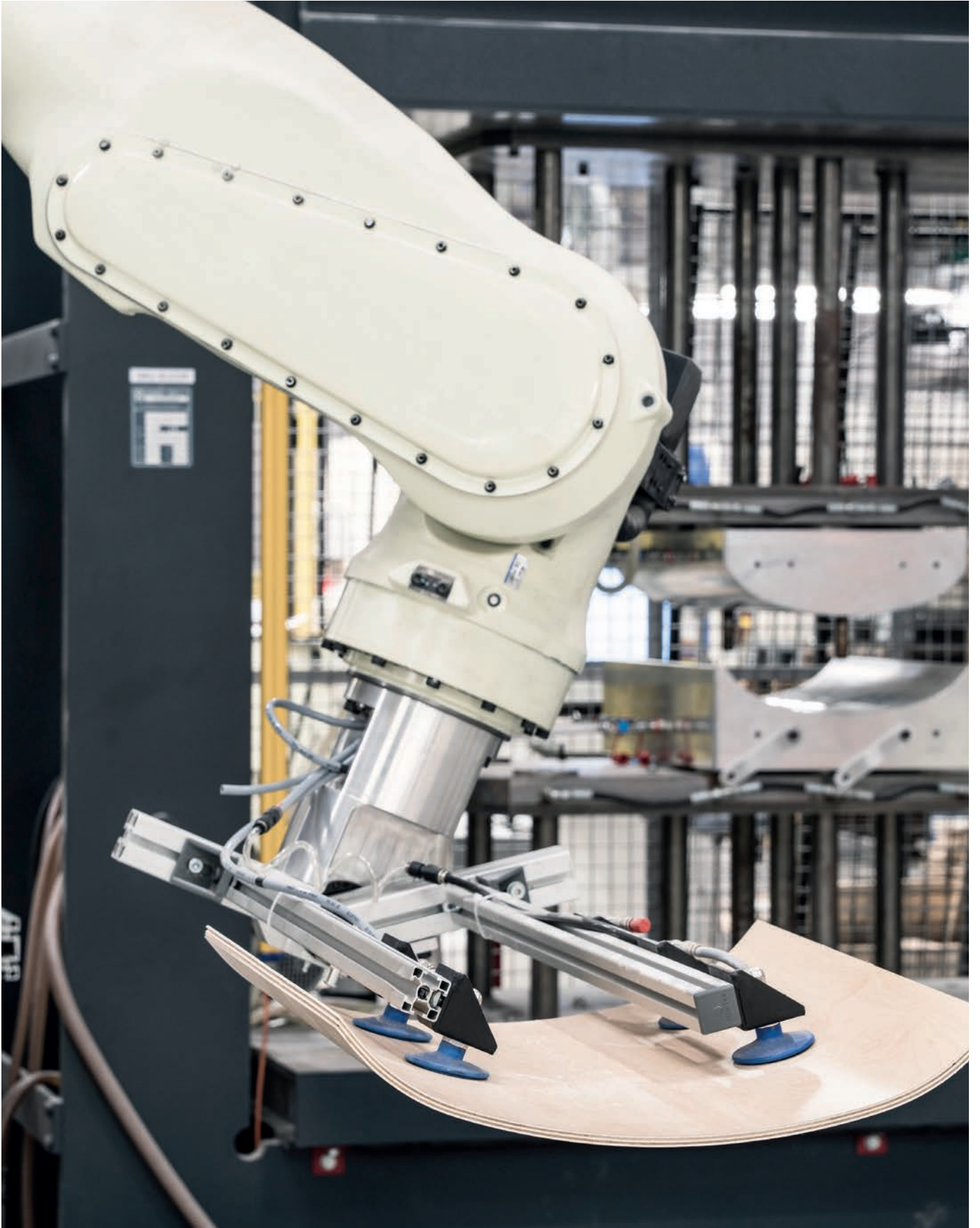



## Sustainability and responsibility through circular economy

For us, responsibility is a guiding principle that covers everything from the design of a piece of furniture to the manufacturing phase and on to its transportation to the final destination. We prioritise Finnish suppliers in our procurement operations and only purchase timber from sustainably managed forests. We always ensure that the raw materials of our supplier chain come from responsible sources and encourage the use of local producers. We want to create jobs in Finland while becoming global in a responsible manner.

We are the only industrial company in the Finnish furniture sector that uses a PEFC Chain of Custody system to track the origin of its timber. We know the origin of all timber that comes to our factories. Our tracking system covers every item in our standard collection. At our shops, you can buy a sofa made from 100% Finnish raw materials.

We have strict environmental requirements for the materials we use. A number of our products have been awarded the Nordic

Swan Ecolabel. We aim to minimise emissions from our furniture to indoor air by methods such as using only water-dilutable surface treatment agents. To ensure the purity of indoor air, we choose wood-based boards carefully and use thermo-formable Grada plywood that contains no formaldehyde adhesives. Isku's Still and Step+ are the world's first office chairs with M1 classification. The M1 classification proves that the products' emissions into indoor air are demonstrably low.

We foster a circular economy mindset and think carefully through the lifecycle of each of our products from the designer's desk to a finished piece of furniture. We want to save energy and aim to recover the byflows created in the production of one product as the raw material for another. An example of this thinking is our Kivikko product family. At the product development phase, we study the durability and safety of product prototypes in our testing laboratory and make the necessary improvements.

# Customer segments



As an expert in work environments, Isku provides modern and functional solutions for today's needs. As the forms of working are becoming increasingly variable, Isku's extensive offering provides a solution for every situation. Bringing creativity and satisfaction into day-to-day work is our key objective: with adaptable, multifunctional solutions we can meet evolving demands with durability and timelessness. Solutions that are innovative and beautiful to look at make every work day better.



Isku Health is a forerunner as the provider of furniture for the healthcare sector. Isku Health supports the work of healthcare professionals and helps patients feel better sooner by creating safe and comfortable healthcare facilities and care homes. The design of the facilities is based on the official guidelines for hygienic design, and cleanliness is maximised through the use of antimicrobial materials in all critical touch surfaces. Antimicrobial surfaces help prevent infections and keep them from spreading.



For Isku, concept furnishing means providing our customers with comprehensive service – all the way from the designer's desk to manufacturing and installing the products. Together with our customers, we develop products, solutions and concepts that help them achieve their targets. Cornerstones of our design are ergonomics, usefulness and antimicrobial products, which help our value proposition of the best and the quickest service to be materialised for the benefit of our customers.



At Isku, we design and furnish environments where learning and teaching is a shared joy. Our complementary facility and furniture solutions – Focus, Share, Study & Join – are a source of inspiration, learning and creating something new. This is the concept of Isku Active Learning: providing the tools for creating functionally and pedagogically versatile learning and innovation environments.



Isku Living is the ideal collection for furnishing the home of your dreams. It also brings comfort and enjoyment in work environments, schools and other public spaces. Timeless, elegant, modern or trendy, relaxed and cosy – the collection is full of choices for a variety of tastes, unified by excellent design and high-quality materials. Products by Isku are manufactured in an environmentally sustainable manner and tested to be durable.



As work environments – as well as work itself – are undergoing a period of transition, we are bringing our 90-year expertise and customer insight to help in the evolution of workplace communities. By listening to people, we and our versatile services can make our customers' day-to-day life easier and help them take the step towards better solutions. Each solution is tailored for the specific customer and oriented towards the human user. Because we all spend a major share of our daily lives in work environments, our learning and work environment services are also designed to support you through various transformations.

# Isku Active Learning

Focus

Study

Share

Join



## Smart learning and innovation environments

At Isku, we design and furnish environments where learning and teaching is a shared joy. Our complementary facility and furniture solutions – Focus, Share, Study & Join – are a source of inspiration, learning and creating something new. Together they form a pedagogically versatile concept of Isku Active Learning.

Isku Active Learning environments are safe, functional and enjoyable. The right facility and furniture solutions create peaceful work environments, improve learning results and contribute to the health and well-being of all members of the learning community.

### **An adaptable learning environment encourages creative learning**

Isku Active Learning solutions adapt themselves flexibly to a variety of situations and learn together with their users. They allow not only for a variety of learning, teaching and guidance styles, but also for the specific needs of different subjects. A well-designed room can suit a multitude of purposes.

The furniture can be quickly moved and easily rearranged to suit changing needs. As modifiable learning facility and furniture solutions encourage users to reconfigure the set-up for individual work and collaboration, it helps to promote creative solutions and rethinking matters from a different perspective.

Thanks to the easily adjustable Isku Active Learning environments, students can become active designers and developers of their own learning environment. Isku Active Learning solutions create an innovation platform reinforcing students' own initiative and inspiring them to find, try and create new solutions together.

### **Digitisation and technology make learning environments more versatile**

Learning takes place everywhere, all the time. Mobile technology and social media have improved the opportunities for social learning. Wireless networks and smart devices enable the information within a community to become shared information. Indeed, digitisation of teaching and learning and evolving technology are now an inseparable part of learning environments, their functionality and development. Therefore, our modern ideas of learning and pedagogy require updated work environments and tools for both students and teachers.

Isku Active Learning is a total solution. User-oriented design enables digital, virtual, social and physical learning environments to be consolidated into a practicable formula dedicated to serve the objectives of teaching.



## FOCUS

### Solutions for independent work as a part of community-oriented learning environment

Sometimes studying requires independent work and individualised solutions that support students' personal learning pathways. Students should be provided an opportunity to occasionally withdraw from social interaction and concentrate on uninterrupted work. Facility and furniture solutions inspire and support an active approach among students, promoting self-directed, insightful learning.

The Focus solutions create possibilities for uninterrupted, concentrated work that involves organising one's learning and acquiring and applying knowledge. In a learning space, the Focus solutions provide teachers an opportunity to tailor their teaching to the needs of small groups or individuals and allow students to proceed at their own pace while following the teaching at the class.

Even teachers sometimes need to work uninterrupted – when planning their work or dealing with confidential matters, for example. The Focus solutions also bring new ideas for staff lounges, meeting rooms or offices.

The Focus solutions consist of innovative layout of furniture, mobile space dividers and *space-within-a-space* furniture specially designed for the purpose. An essential element in each Focus solution is the management of acoustics and visual stimulation to minimise disturbances.





## SHARE

### Solutions promoting peer learning and teamwork for all environments

The Share furniture solutions provide a variety of shared learning spaces for investigative, problem-based work in small groups, where students learn together by exchanging, evaluating and combining knowledge. The Share solutions are ideal for rooms that promote interaction within a group: round tables combined with half-round or round seating create a safe setting for peer-group studying and creative learning.

Flexible room and furniture solutions are designed to support phenomenon-based learning and project work where activities and targets guide the layout of furniture. The physical learning and teaching space can be adapted quickly and creatively to the needs of different groups or pairwork.

The Share solutions find their places easily in any room or space of an educational institution, both as small and large sets. They are particularly well suited to furnishing open and extendable learning environments and rooms and halls intended for very large groups. In a classroom, the Share solutions support versatile pedagogical styles and enable a flexible use of various working methods.





## STUDY

### Insightful solutions for multifunctional classrooms

Learning spaces and their design are an elemental part of the overall architecture of any school. Flexible furniture solutions can turn even traditional classrooms into multifunctional spaces that promote interaction between the teacher, the student group and individual students. The Study solutions are adaptable facility and furniture solutions for teaching and learning new things. They are just as suitable for traditional lecture-type teaching as for interactive work in groups or pairs or test situations measuring individual learning results.

Furniture in a learning space can be easily adapted from individualised work to a variety of group arrays. Their adaptability allows for the use of a variety of teaching and working methods and makes the space suitable for teaching different subjects. The furniture can be easily moved, even by students themselves, and can also be stacked away to give room for physically active learning.

By adjusting the height of individual items and combining furniture of variable height, it is possible to create new dimensions and amphitheatres in ordinary classrooms. Variable combinations of upholstered and hard furniture also help to rethink traditional classroom teaching.







## JOIN

### Solutions for communal spaces that inspire interaction and creativity

Promoting inclusion and a communal culture is a vital part of the fundamental task of schools and educational institutions. The Join furniture solutions are ideal for creating living rooms for all users: for spontaneous interaction and encounters before, after and between lessons or just for hanging around. Designed from pedagogical standpoint, the Join solutions promote positive social interaction, inclusion and communal learning. They are designed for the workdays and holidays of educational institutions, but also lend themselves to many other uses according to the needs of various user groups.

In communal spaces (halls, lobbies, corridors), innovative, even playful furniture solutions encourage not only creative relaxation, but also self-directed studying, alone or in groups. At their best, these spaces can transform into rooms for parallel learning and teaching during lessons and open learning environments. When furnishing dining hall or canteen facilities, the Join solutions help to create a "café" atmosphere with variably grouped furniture that, outside mealtimes, provide a setting for meeting and spending time with other students.



# Highlights | Solutions



## **Kalliola School, Hollola, Finland (pre-primary education, grades 1-6)**

Kalliola School in Hollola is a new, modern educational institution with functional facilities for 500 pupils in pre-primary and primary education. In addition to the school facilities, the building also houses the local library and health services as well as meeting rooms and sports facilities designed for after-school activities and various spaces for youth work.

The foundation for the design of the facilities of Kalliola School is the National Core Curriculum 2016. In this school, the traditional idea of a “home classroom” has been abandoned in favour of open, flexible and adaptable learning environments. The space and furniture solutions enable a transformation from teacher-centered classroom teaching to student-centered, self-directed learning.

The furniture was carefully selected and designed on the basis of the school’s pedagogical programme. With appropriately selected furniture, it was possible to create learning corners and islands even in open-plan spaces. This also helped to improve acoustics and made the learning spaces more enjoyable while allowing the use of latest teaching technology to support learning.

The school hosts a great variety of working spaces, playing areas and areas for relaxation, but also rooms suitable for more traditional classroom teaching. The furniture solutions support flexible grouping and studying also in other postures than sitting at a desk – here, it is possible to study in a cosy hut or while sitting on a stability ball!

The imaginative staff of the Kalliola school helped in finding new furniture solutions to support their day-to-day work. Innovations yielded by the shared product development process are visible in items such as the storage furniture, the desks adjustable with gas cylinders, and charging solutions.

*“I firmly believe that this physically active environment makes children much more motivated to study. Throughout our collaboration in choosing the furniture, Isku demonstrated its open-minded approach in many ways. We are extremely thankful for many new furniture solutions created during this project. The collaboration in product development was excellent”,* says headmaster Aarne Ylipiha.







## Environmentally friendly choices and sustainable solutions

In the design and manufacturing of our furniture solutions, we comply extensively with the principles of sustainable development. It is important for us to know the origin of our timber and be assured that it has been sustainably produced. Indeed, we are the only industrial company in the Finnish furniture sector that uses a PEFC Chain of Custody system to track the origin of its timber.

Isku is an active developer of environmentally friendly production. Our environmental management system is certified to meet the requirements of standard ISO 14001. We want to design products and services that meet even the strictest environmental standards. In our quality work and lifecycle thinking, we take into account the origin of materials, energy consumption during production, the use of chemicals, and the volume of waste generated during the entire production and consumption chain up until the recycling of products at the end of their lifecycle. In our purchases, we prefer Finnish, environmentally sustainable materials.

Isku Active Learning solutions are a durable choice also in terms of pedagogy: The furniture and the learning environment solutions built from them will stand the test of time and the transformation of operating environments. They allow for a wide variety of pedagogic styles and answer the evolving needs of learning spaces. As curricula change, pedagogically flexible learning environments adapt to new functional requirements.

These are the fundamental principles to which Isku has remained committed for more than half a century as the leading Finnish expert in furnishing learning environments. In the future, we aim to be an even more agile everyday development partner for our customers.

## Agile, customer-oriented product development

In Isku's product development processes involving learning and innovation spaces, the highlight is on the users, because they are the best experts of their own environments and needs. The best ideas and innovations are created as solutions for everyday challenges. The development of both total solutions and individual pieces of furniture is based on user experiences, customer feedback and improvement ideas, combined with Isku's advanced expertise in providing solutions.

Our product management team is located in Lahti, near our factories, which enables agile responses and seamless cooperation between our customers, designers and production. Because design and production are located in the same unit, we are also able to modify our products to suit the needs of individual customers or projects. At their best, customer projects help us create entirely new products that find their place in our Isku Active Learning collection.















## Riihenmäki School, Mäntsälä, Finland (combination school, grades 1-9)

The Riihenmäki combination school has about 700 pupils and 60 members of staff. When the school building was extended and renovated, the classrooms, dining hall, teachers' offices, corridors and lobbies were refurnished and turned into learning environments that strengthen the culture of the modernised school. It was only natural that the teaching staff and other employees were actively involved in developing furniture solutions.

The learning environments of the school reflect pedagogical diversity and suitability for both different ages of pupils and various learning styles. Some classrooms have been furnished as flexible teamwork spaces, while others are equipped with solutions that are more suitable for self-directed, independent work. Small, separate rooms connected to larger learning spaces provide a peaceful environment for tailored teaching while the rest of the class is studying in the larger room.

What is particularly remarkable in Riihenmäki School is the use of corridors. With cost-effec-

tive furniture solutions, it was possible to put corridors into effective use by turning them into parallel learning spaces during lessons. Outside lessons, they provide a communal space for relaxation, hanging around and meeting friends.

Suitability for a multitude of purposes and functional design were the guiding principles in furnishing the dining hall. The location of furniture was determined on the basis of service counters and the directions by which pupils move to make the lunch break a smoother experience for everyone. In selecting the furniture, the use of the hall as a versatile learning space outside lunchtime was also considered. Thanks to the multi-level solution, the dining hall doubles as a venue for performances and events.

Riihenmäki School is an outstanding example of a project where the harmonious architecture, colours and furniture in the building together create an enjoyable work environment for all its users.



## Isku Active Working solutions create enjoyable and functional work environments

In providing furniture for kindergartens, schools and educational institutions, the highlight is on learning and the learners. However, it is just as important to consider these spaces from the perspective of improving the working environment for the members of staff. By highlighting work ergonomics of teachers and choosing the furniture solutions in the teachers' lounge and staff offices carefully, it is possible to create functional, enjoyable work environments that promote the job satisfaction and health of all members of staff.

The design of staff offices and desks is always based on the needs of users, because they are the best experts of their own work. Isku Active Working solutions help create functionally versatile work environments that encourage physical activity and can be adapted to various needs.

A well-designed, functional and flexible teachers' lounge lends itself to a multitude of purposes. It is a place for meeting colleagues, exchanging experiences and discovering ideas together. An enjoyable teachers' lounge is a workspace that supports the best possible performance of teachers in their work. The Focus solutions also bring privacy in communal teachers' lounges, while the Share solutions improve teamwork opportunities.











## User-centred design to meet the needs of professionals

In the design of Isku Active Learning environments, the users are the protagonists. Every building, every project is unique for us.

For each project, we appoint an interior designer or architect who is responsible for the project and its progress according to the wishes and identified needs of the users and the architecture of the building, ideally joining forces with the construction architect at the very beginning of the project. The joint design project is guided by the objectives of the functions planned for each room, the needs of various user groups and authority regulations.

In designing learning and innovation environments, the main focus is on the right furniture solutions and their pedagogic usability. A well-designed learning environment is beautiful and enjoyable and motivates both the community and its individual members to succeed in their fundamental task.















## Taatila School, Lieto, Finland (pre-primary education, grades 1-6)

Taatila School is a prime example of a Finnish local school with pupils from kindergarten children to sixth grade.

The design project of the facilities and furniture for the Taatila School relied heavily on the needs of users: the school staff participated actively in designing the facilities and finding ideas for furniture solutions at every stage of the project. At the beginning of the design process, the staff studied learning environment solutions in various reference projects. Next, the quality of the products was examined in a showroom and during a visit to the Lahti factory. Ideas and wishes were refined into choices in the course of joint workshops targeted at finding the best furniture solutions to support different styles of teaching and learning.

The guiding principle of the design process was to create a fresh-looking, inspiring, dynamic and imaginative environment that highlights the beautiful architecture of the building. Thanks to its large windows, the building is very well lit. For this reason, it was hoped that the colours of furniture could also

be crispy and airy. The excellent acoustics of the Taatila School building are supported by the surface materials of carpets, upholstered furniture and acoustic panels on the wall.

The decor was chosen to lend itself to a wide variety of different work situations for both pupils and teachers. Every room can be quickly adapted to the particular learning situation: desks can be stacked away and seats can be hung on the wall with magnets. The furniture is not bound to any particular room: stacked items with wheels and harmonious colour themes can be moved freely and easily from one room to another.

The needs of users of different ages were also taken into account and the rooms are now equipped with versatile, adjustable furniture solutions suitable for groups of all ages. Functional interior decoration solutions were found for different classrooms, corridors and halls, group work spaces, the dining hall and the library. The purpose of the selected furniture is to support pupils' growth into physically agile and active citizens.



## Safe choices

One of the guiding principles in creating and choosing furniture for learning environments is the safety of functions and users – because everyone has the right to study and work in a risk-free environment. Safety aspects are further highlighted when classrooms extend into flexible, adaptable learning environments. Safety should be taken into consideration from the beginning of the design of the facilities, and equipment, devices and furniture with materials and manufacturing technique that guarantee their safe use should be preferred. Products should also be used only for their intended purpose.

At the heart of Isku's product strategy lies product safety, a combination of the product's aesthetic and technical design, ergonomics, sustainable material choices, the impact of the materials on indoor air, and the aspects related to the life cycle and recycling of the product. We design and test our furniture to meet current standards and directives. The durability and product safety of our products meet the strictest requirements for furniture in public spaces.









## The first antimicrobial furniture collection in the world

In shared public spaces, various infections spread easily, and attention must be paid to prevention and breaking up the chain of infection. In addition to high standard of hand hygiene and careful cleaning, antimicrobial materials also help to reduce the spreading of infections from touch surfaces.

Studies have found that Isku+, the first antimicrobial furniture collection in the world developed by Isku, demonstrably reduces the spread of infections in kindergartens, educational institutions and healthcare facilities. This innovation by Isku is based on natural copper and silver technology and employed in surfaces, fabrics and upholsteries that actively prevent the spread and transmission of infections.

**ISKU+** adapts itself to the furnishing needs of any space: all Isku items can be manufactured from antimicrobial surface materials and upholstered with antimicrobial fabric. For kindergartens, schools and other educational institutions, we recommend antimicrobial tabletops for environments shared by large numbers of users: dining halls, lobbies and open learning environments. Also in classrooms, staff lounges and the school nurse's offices, the use of antimicrobial furniture reduces the risk of infection.











## Salpausselkä School, Lahti, Finland (grades 7-10)

There are 550 pupils at Salpausselkä School. The school staff played a key and active role in the school design process. The teaching staff jointly defined the functional objectives for the learning environments and the interior design guidelines that covered the lobbies, offices, staff facilities, meeting rooms, offices and the dining hall. The teachers wanted to have a colourful, happy environment, which is nicely reflected throughout the school. The backbone of the design consists of five main colour themes that are repeated in different rooms and spaces. All corridors are painted the primary colours, which also help students find their way around the school building.

One of the design targets was that when students move from one subject to another, the look and feel of the classroom would change as well. In this way, the environment gives a visual clue that there is something new coming up, and a change in the physi-

cal learning environment offers inspiration to take up a new subject. The material choices of furniture were also carefully considered. For example, the tabletops in the school's physics and chemistry classrooms are made of a special laminate that is more resistant to chemicals, and the upholstery of chairs was chosen to suit laboratory environments.

The target was to make the teachers' lounge a multifunctional room for work and relaxation. Even a large communal space can lend itself to the needs of many types of work when it is divided into different functional zones with clever grouping of different furniture.

The result is lively and happy, reflecting the school culture that highlights active participation. The facilities serve the fundamental task of the school well.







## Wellbeing through ergonomic furniture

The design and form of our furniture take into account the unique characteristics of individuals. Thanks to the adjustable height of sitting desks and seats, it is possible for every student to have a correctly dimensioned workspace.

Desks that can be easily adjusted to standing height provide both students and teachers freedom of choice and an opportunity to be physically more active. For active standing work, add a balance board or a standing mat! Chairs can also be replaced with various height-adjustable active chairs. For those with the need for speed, try Desk Bike seats (p. 127).

In addition to work ergonomics of students and teaching staff, we always consider the acoustics and lighting conditions of the facilities as part of our total design solution.















## Satakunta University of Applied Sciences, Pori, Finland

Satakunta University of Applied Sciences has about 6,000 students and 400 members of staff. The brand new Pori campus completed in summer 2017 is home to about 3,500 students and 300 members of staff.

The facilities of the Pori campus were designed with their users in mind, and the way the different groups of users act in various situations and everyday encounters were studied carefully in the design phase. The guiding principle in the design of the facilities and the furniture was to foster and nurture community spirit, inclusion, participation and collaboration. The purpose of all facilities in this educational institution is to support encounters and dialogue between students of different subjects, the teaching staff and the representatives of the business community, creating a platform for new ideas and innovations. This is the idea behind the ground floor of the building: it was designed to be an inviting meeting place, an agora, which also provides a natural location for the library and the campus

restaurant. The need for semi-open discussion corners was considered when furniture was chosen for the lobby. The selection and location of furniture also contribute to a pleasant acoustic environment.

The learning spaces were designed to be adaptable, and their multidisciplinary purpose is further highlighted by movable, stacked furniture. Different needs of students in terms of working heights and positions were also considered in the design. The unique look is a result of adventurous, inventive choice of furniture, a clever use of different heights and adjustability, and a combination of hard and soft items.

In working spaces, the focus is on the natural integration of technology in work and learning environments. Electrical installations and the technical properties of the facilities were considered carefully to enable both existing and future technology to serve multidisciplinary teaching in the best possible way.









## Isku Digital Learning Lab – more than technology

Isku is heavily involved in the everyday activities of educational institutions, and we are more than just observers of the constant change of operating environments. The development of flexible, innovative work and learning environments is a part of our strategy and a task that we are happy to assume. The environments for learning and teaching are evolving and becoming increasingly versatile with an efficient use of different physical learning environments and a creative integration of ICT to support learning.

The Isku Digital Learning Lab is a total solution for individual rooms and spaces that combines the room, the furniture and the technology into a functional digital learning workshop. A new or existing room – or even a little used corridor or lobby – can be flexibly converted into a digital learning lab. The solution is always designed in collaboration with a teaching technology expert and the users of the space, paying particular attention to the desired purposes. The total concept of the Isku Digital Learning Lab covers not only the design and delivery of furniture and the technical equipment, but also the installation and support in the scope determined by the buyer.

The Isku Digital Learning Lab serves the evolving needs of teaching. It provides both learners and teachers a well-functioning, durable and adaptable space that does not limit the style and methods of teaching, but supports the learning that takes place within.

## New ideas are created in spaces for creative encounters

Educational institutions are active in building partnerships, engaged in their fundamental task together with their stakeholders. Collaboration with society and the business community has a major role in the activities of each school and educational institution. In many cases, the building of an educational institution provides a meeting space for the entire community and a centre for communal learning – just like the agora of the Antics.

Carefully selected Join and Share solutions help create inspiring and functional spaces, where a culture of cooperation is strengthened and where thoughts and ideas can meet and give rise to innovation.

Facilities, as well as the furniture, must also serve various user groups outside the business hours of the educational institution. Our furniture design plan always takes into account the various needs of stakeholders and communal activities.



















# Highlights | Products



## Kivikko

Design Henri Halla-aho

Kivikko is an award-winning, multifunctional product family ideal for creating versatile spaces for work, learning and relaxation for users of all ages. Kivikko products come in various shapes and heights and can be combined into small or large groups creating a landscape of seating that perfectly serves the purpose of the room. For more functionality, add some Kivikko tables.

All the furniture of the Kivikko family are easily movable and can be equipped with wheels.

As the height and depth of Kivikko seats follow the measures of the Amphi family (p. 88), the two series work well together.

Kivikko is made of surplus and leftover cuts of foam plastic products. Even the leftovers of the manufacturing process of Kivikko products will be recovered as raw materials.



Kivikko was awarded the Nordic Swan Ecolabel in 2017.



## Noppa

Design Mikko Meriläinen

Noppa is a lightweight, easily movable and versatile seating solution for rooms that need to be easily adaptable. Noppa works particularly well as larger groups. Together with Solu tables (p. 111), it provides a fresh option for furnishing classrooms and extendable learning environments. Thanks to its classic, symmetrical shape, Noppa can be stylishly combined with existing furniture, bringing new usability to all kinds of spaces in a cost-efficient manner.

Noppa is a flexible solution for furnishing learning environments. The belts around the cubes make them easy to move. With Noppa seats, it is also possible to quickly build temporary space dividers or nest-like learning corners, or change the acoustic conditions of a room.









## Mukula

Design Kaija Aalto

Mukula is a practical, fresh seating option for kindergartens and schools. The seat cushions attach to the Mukula wall by magnets, creating a noise-absorbing element and bringing colour and variation to indoor decoration. The seat cushions are available as circles, ovals, squares or triangles. Colours can be varied according to other decoration or pedagogic purposes.

Use different colours and shapes as part of other pedagogical activities to support learning! Very young pupils learn colours, shapes and composition through play and experimentation. Older pupils can use Mukula seats innovatively in designing their own learning environment. The seats are available in three different heights. Stack the cushions to get a suitably high seat for both adults and kids.



## Amphi

Design Henri Halla-aho

Amphi was created from the need to design for open learning and work environments a set of furniture that makes it easy to meet others, have a chat and interact. The basis for the design is the image of an amphitheatre, the place for meetings and performances in the Antics.

By combining Amphi seats of various heights, it is possible to create an auditorium-like landscape of seating. The standard layout makes a theatre suitable for performances and lectures, but Amphi provides unlimited opportunities for using imagination and

creativity to build and design innovative learning environments.

As the height and depth of Amphi pieces follow the measures of the Kivikko family (p. 82), the two series work well as a variety of combinations. Like Kivikko, Amphi can be made even more mobile by adding caster wheels. Amphi is an environmentally friendly choice, because its material are recycled from surplus and leftover cuts of foam plastic products.





## Tutto

Design Mikko Laakkonen

Tutto is a chair family that can be adapted to a multitude of applications. The chair features a single seat section that is available in pressed wood or upholstered. A low or high backrest, wooden or upholstered, is fastened to the seat section. There are four different leg options available for the chair: four-point or loop legs and two different star bases. With the low backrest and short legs, Tutto serves as a general-purpose chair. The high backrest turns Tutto into a distinguished conference chair. The chair family also has options for high seating. The various elements can be combined into an almost unlimited number of options, each with their own function.





## Prima

Prima is a versatile student chair with a design focused on ergonomics and comfortable work – not forgetting safety. The backrest of the chair is designed to support the lumbar region. The height of Prima chairs is always adjustable, whether you choose the traditional, mechanically adjustable frame or a steplessly adjustable gas-cylinder star base with caster wheels.

The seat and back sections of Prima are available in laminate, recyclable polypropylene or wood-plastic composite. Carefully selected details and a variety of leg/base, material and colour options make Prima a versatile, inspiring piece of furniture that helps to create a unique look in learning spaces. The wave form of the backrest of the laminate chair is also great for hanging a backpack.









## Kaari

Design Henri Halla-aho

Kaari is a modular sofa system that helps to create intimate discussion and work areas in the communal spaces of educational institutions. It is ideal for open and extendable learning spaces, dining halls, lobbies and corridors. Kaari can be turned into exciting architectural shapes by combining straight and curved elements creatively to suit the purposes of the space. Create a unique look with the choices of shapes, colours and upholstery materials.

Combine Kaari sofas with acoustic panels and accessories to build Learning Lab spaces for large or small groups in any communal space. In the Isku Digital Learning Lab, solutions that support the active use of learning technology, the chosen Kaari solution, can be complemented with an integrated electric supply that can be plugged into a standard power supply and a touchscreen with a movable stand.





## Dyyni

Design Tapio Anttila

The Dyyni sofa system is a versatile set of furniture that can be combined into single-seat armchairs, distinguished sofa sets, or anything in between. Thanks to its classic forms, Dyyni is suitable for most rooms and combines naturally with other furniture. By creatively combining the modules of the Dyyni system and choosing inspiring colours, it is possible to create exciting, unique and well-functioning solutions for living and meeting spaces. In addition to various seat pieces, it is also possible to integrate the table/magazine shelf module into the system.

Equip Dyyni with caster wheels to create a useful sofa solution for spaces that need to be adapted quickly to different purposes.



## Inkoo Pro High

Design Ilari Jääskeläinen

Inkoo Pro High is an acoustic armchair that provides a sheltered space for working or spending time alone or with others. The extra high backrest and sides of the chair are designed to provide privacy in various communal spaces. For even more shelter, it is also possible to unite two facing sofas with the Inkoo Pro High space divider to create a clearly separated workspace for pairs or small groups. In large communal spaces, the architecture of the space and the role of the sofa set can be highlighted with the selection of colours and materials.

As a pop-up solution, Inkoo Pro High is particularly suitable for corridors and lobbies in educational institutions, teachers' lobbies and offices as well as libraries. In a classroom, Inkoo Pro High supports tailored teaching and self-directed learning by providing an option for independent, focused work.







## Pisa

Design Desigence

Pisa is a set of functional, lightweight furniture specially designed for the needs of educational institutions. The Pisa product family consists of chairs, available with either four-point or loop legs or star base, two different general purpose tables and stacked lecture tables. The tables and chairs are lightweight, slender and easily stacked. The patented, innovative linking and hanging properties are easy to use and make the furniture even more versatile.

The design and development of the Pisa product family emphasises both the functionality and the design of the products with many beautiful details. By varying the colours of the pipe frame and the laminate parts, it is possible to create unique, playful solutions.



## Ark

Design Henri Halla-aho

Give new life to communal spaces by creating well-functioning, inspiring combinations of the Ark modules that adjust to the purpose of any space. The designer wanted to create a landscape-shaped, modular furniture system that can be turned into versatile, creative solutions for storage, work or meeting others. Insightful design and a large selection of materials and colours help to create a variety of atmospheres. Soft materials improve acoustics, while the caster wheels that can be added to any module make the furniture more functional.

In addition to storage cabinets, it is also possible to integrate seating or tabletops into the Ark system. Ark cabinets are available with or without a lock (key lock, mechanical combination lock or electric lock). It is also possible to equip the cabinets with an integrated power supply that can be plugged into the electric supply of the building and turns the cabinet system into a secure charging station for computers, mobile phones and other smart devices.









## Mode Akusto

Design Juha Lähti & Juri Karinen

The Mode Akusto product family helps adjust and improve the acoustic conditions of any space and creates adjustable learning spaces for changing individual and communal needs. The partition walls absorb noise efficiently and help to create a quiet work environment. The dual structure of the walls not only absorbs sound inside the wall, but works just as well in both directions. The sound absorption class of the walls is B.

Front or side walls are easily attached to desks and turn ordinary work or student

desks into sheltered workspaces with a pleasant sound environment. Mode Akusto side walls create quiet language labs and spaces reserved for the individual work of students or teachers. The freely standing floor walls can be combined into short or long partition walls. With optional caster wheel legs, the floor walls become even more easily movable.





## Roller

Design Henri Halla-aho

The Roller trolley is a result of a user-centred product design process, created as a solution for the storage of students' backpacks and sports equipment. It is a steady and versatile storage trolley not only for backpacks, but also for books, games and teaching equipment. Designed to move, it brings both flexibility and order to any space. It also helps to make shared storage rooms more functional: when tools and materials needed in teaching can be stored on trolleys instead of shelves, it is easy and handy to move them from one room to another. The Roller helps keep balls and skipping ropes in order in a sports equipment storage room.

Thanks to its large rubber wheels, it moves easily and silently. Roller has four caster wheels, two of which are locking.



## Poiju

Design Henri Halla-aho

Poiju is a versatile low table for a variety of sofa and seating sets. In learning environments, Poiju is easy to combine with Kaari sofa systems or Kivikko, Noppa and Mukula seats.

Thanks to its ingenious structure, it is easy to integrate a plug-in power supply or a wireless charging plate for mobile phones in the table. Optional caster wheels make Poiju easily movable.









## Solu

Design Henri Halla-aho

The Solu table is the result of a user-centred design process in collaboration with the teaching staff of Heinsuo School and Kalliola School.

Solu is an easily movable small table available in two different height adjustment ranges and three different fixed heights. The stepless gas-cylinder height adjustment encourages users to abandon their static work postures, because it allows for both sitting and standing work. Thanks to its excellent adjustability, Solu can be adapted to the needs of users of different heights as well as various work postures and a variety of situations. It is also perfect for a side or end table combined with different sofa sets. Thanks to the variety of top and leg options available, there is a suitable combination for every solution, and the selection of the top colour offers an opportunity to add a fresh accent to any room.



## Move

Easily movable Move tables with locking wheels are an ideal solution to a room that needs to be flexible and adaptable for different purposes with frequently changing furniture layout.

Move tables with folding tops save space and suit a variety of purposes: group work and meetings, side tables or student desks. Thanks to the easy-to-use, responsive and reliable mechanism, it takes only seconds to fold a table away or take it into use again. When the tops are folded, the tables need little storage space.

The Move table with a gas cylinder is an

excellent choice for rooms where the desk solution must be easily movable without compromising work ergonomics. The table is equipped with caster wheels and a stepless gas cylinder, making it steady, but easily adjustable. It is a great option for a standing workspace or a group desk, combined with different height-adjustable active chairs. In a classroom, Move also serves as a teacher's desk that can be moved smoothly according to the needs of changing teaching situations. The size and shape of the table top can be selected to suit the particular space and purpose.







## Summa

Design Tapio Anttila

The Summa product family is great for learning spaces where functionality and adaptability are the key and students want to stay physically active. The Summa tables offer the perfect solution for a variety of individual, pair or group work situations.

The Summa table designed for individual work can be flexibly combined into a variety of group work configurations. The size and shape of the table top can be adjusted to the purpose of the space and the needs of the users (see the different tabletop varieties on page 202). When necessary, the table

can be equipped with locking wheels, making them easily movable – even for very young pupils.

The Summa tables for pair work are designed to be space-saving solutions particularly in group work and lecture rooms, where the tables can be combined into a variety of group work configurations. Thanks to the special attention paid to the dimensions and shapes of the tabletops, the tables can be easily linked, but there is enough work space even on a detached table.



## More healthy and lively school days with physical activity

A physically passive lifestyle is a public health problem that starts at a very young age. Of all the time spent sitting during a day, school accounts for approximately 40% of it, and the older students get, the more sedentary they usually are. However, it is possible to make kids more active by increasing physical activity during the school day.

There are two main ways to decrease physical passivity: change either the way we work or the physical environment. Breaks, physically active lessons and an atmosphere that encourages one to be active are examples of best practices. Activity-encouraging furniture makes it easier to learn physically active ways of doing things and integrating them into the school day. At their best, active furniture reminds and encourages us to be active, even when the actual ways of working do not change.

Staying physically active not only promotes health, but also makes students more alert and improves their learning results. The most important effect is the learning of a physically active lifestyle that can be maintained throughout one's life.

Arto Pesola, Doctor of Philosophy (Sport and Health Sciences), exercise physiologist, research manager, Active Life Lab, South-Eastern Finland University of Applied Sciences entrepreneur, Fibion Oy



## Mix

Mix is a new alternative for a traditional student desk. Its height can be adjusted quickly and easily with a gas cylinder, operated with the button integrated on the edge of the tabletop. Thanks to a large range of steplessly adjustable heights, students can find an optimal height for both sitting and standing work.

The Mix table brings new options for furnishing classrooms: Create an auditorium in any class by combining tables of variable

heights. The table can be turned into an ordinary student desk in seconds to suit more traditional classroom use, such as exams. In both tabletop options, the leg of the table is entirely contained within the table footprint, enabling the tables to be easily combined for a variety of work group configurations.



## Furniture can encourage us to move and vary our working posture

Health and well-being are important issues in today's workplaces. Individually adjustable desks and office chairs are also here to stay – in educational institutions. The rise of electrically adjustable desks and high work stations have made a half-sedentary position or standing increasingly popular work postures.

More and more often, a height-adjustable desk is combined not only with an adjustable chair, but various active chairs, balance boards and standing mats that add flexibility and variety to work postures during a day. But changing one's work posture can be adopted as a natural part of the day only if the work station encourages this with easy options.





## Isku Easy T EL

Isku Easy T EL is a collection of electrically adjustable desks with a wide adjustment range and optional locking castor wheels. Equipped with a rechargeable battery, the easily movable desk does not have to be constantly plugged in. A modern solution also in terms of environmental sustainability, the electric desk has a long service life and can be adapted to a multitude of purposes.



## Standing mat

It is a good idea to pair a standing desk with an ergonomic standing mat. Standing on a soft, breathable and thermally insulated mat makes work more comfortable and keeps feet from becoming tired for a longer time. A handy hook makes it easy to hang the mat on the desk edge when not in use.



# Collection

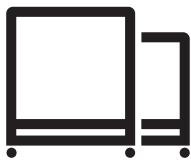



# Seats and chairs

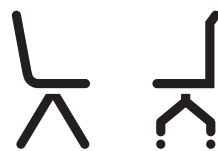

## Pisa

Design Desigence



1002

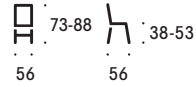

1001

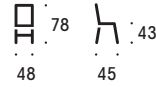

1000

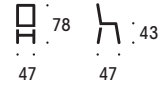

## Mac

Design Raimo Räsänen



3008

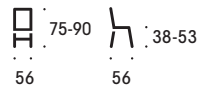

3008 JR

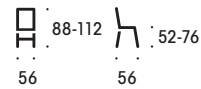

3008

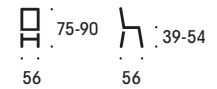

## Prima

Design Raimo Räsänen



1030

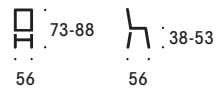

1030, 4-6

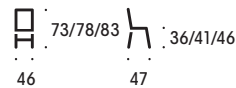

1030, 4-6

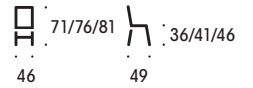

1030, 5-7

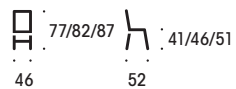

1030, 5-7

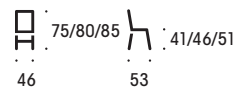

## Tutor

Design Raimo Räsänen



1035, 5-7

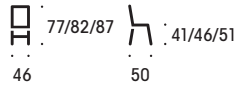

1035, 4-6

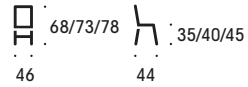

3010

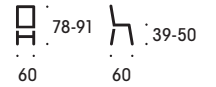

3010 P

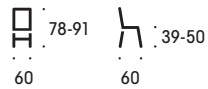

3010 JR

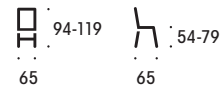

## PRO 6

Design Konstantin Grcic



29860

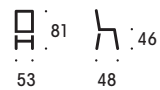

29861

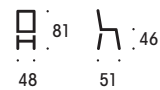

29862

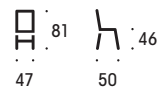

29863

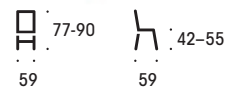

Available with a swinging mechanism

## ILOA

Design Jonas Hakaniemi



29900 ILOA

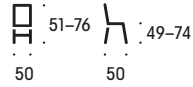

29901 ILOA+

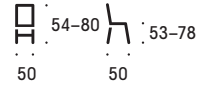

29902 ILOA One

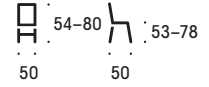

29904 ILOA Joy

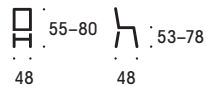

29903 ILOA Smile

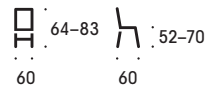

29908 ILOA Smile Bar

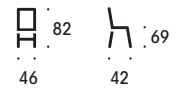

29905 ILOA Bar

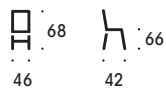

29906 ILOA+ Bar

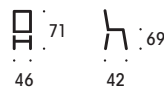

29907 ILOA One Bar

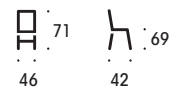

29909 ILOA Joy Bar

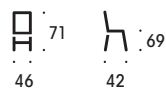



## Muvman



29735

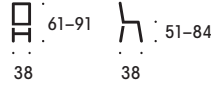

29735

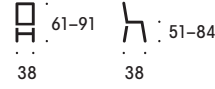

29735

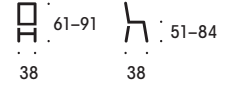

## Ongo



29736 Free active chair

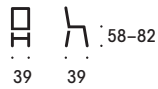

29736 Balance active board



## UPis1



29735

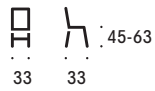

## Desk Bike



29745 Desk Bike

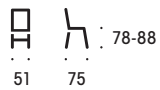

### Salli



29701 Classic

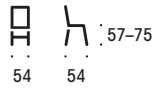

29701 SwingFit



29701 Swing

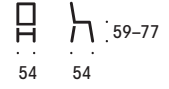

29701 Twin

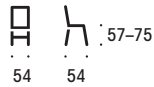

29701 Multiadjuster

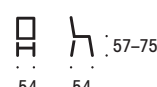

29701 Light

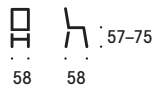

297010 Light Tilt



29701 Light Swing

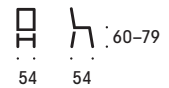

### Cloud



29755

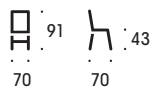

29755

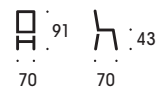

29755

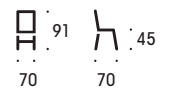

## Still

Design Antti Olin



The various components of the Still series can be combined into tailored office chairs.



3062 Still S2 28



Armrests, soft, 3D 360° ALU

3062 Still S2 29AN



Armrests, soft, 3D 360°  
Mesh neck rest

3061 Still S1AS 28



Conference chair armrests

3061 Still S1AS 29A



Conference chair armrests ALU

3061 Still S1AS 26C



Armrests, soft, 3D ±15°

3058 Still Light S1 22



Still Light, pair of armrests, hard 2D

3060 S1AS 21 JR



## Still Meeting



3055



3055



3054



## Step+

Design Juha Lähti



The various components of the Step+ series can be combined into tailored office chairs.



3070 Step+ 22



3070 Step+ 2s3



Armrests, 3D 360°, black

3070 Step+ 24N



Armrests, 3D 360°, black fabric neck rest

3070 Step+ 3s6



Armrests, 3D 360° ALU

3070 Step+ 37N



Armrests, 3D 360° ALU Leather neck rest

## 3016 office chair

Design Juha Lähti



3016 M

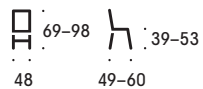

3016 M JR

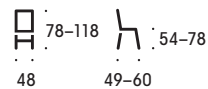

## KAB control room chairs



29705 Director



29706 Executive



29708 K4 Premium



29704 Navigator



29707 K1 Premium



# Rudolf

Design Mikko Paakkanen



3200

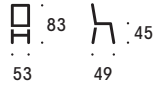

3204

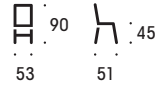

3201

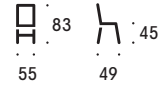

3205

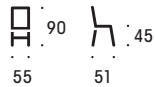

3208

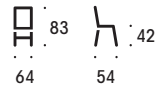

3201 Raised

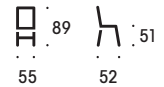

3200

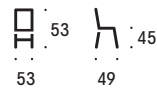

3209

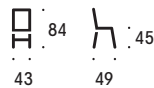

3209

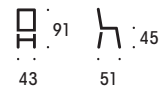

3202

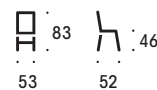

3206

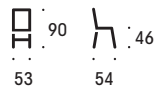

3203

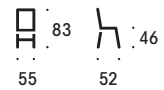

3200



76-90 38-52  
60 60

3205



86-100 41-55  
60 60

3210



83-107 54-79  
60 60

3210



83 75  
57 54

3210



103 75  
57 54

3210



103 75  
57 54

3209



73/83 65/75  
45/46 47

3209



93/103 65/75  
45/46 47

3209



93/103 65/75  
45/46 47

3211



73/83 65/75  
50/52 49/55

3211



93/103 65/75  
50/52 49/55

3211



93/103 65/75  
50/52 49/55

## Tutto

Design Mikko Laakkonen



3240

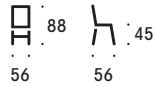

3241

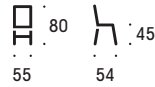

3244

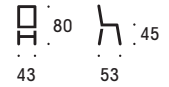

## Lightness

Design Samuli Naamanka



3282 C4

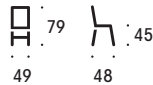

3280 B

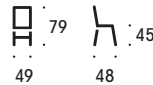

3280 B

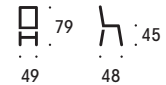

3280 B

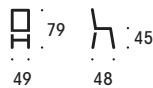

## Lightness chair trolley



3297

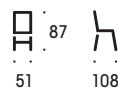



### Chair 50

Design Kurt Hvijsjö



4750

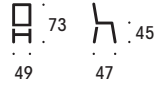

4750

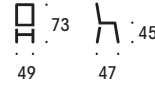

4750

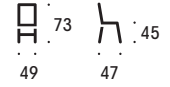

### Matti

Design Juha Lähti



3160

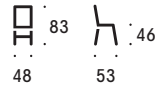

3160

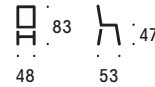

3160

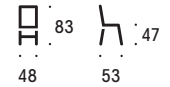

### Matti chair trolley



2954

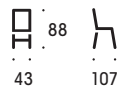

## Logo

Design Raimo Räsänen



3150

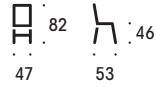

3151

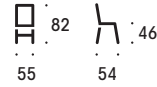

3151 Raised

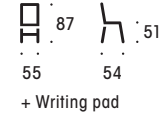

3170

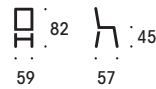

3727

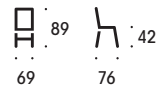

3727

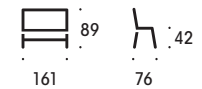

## Signum

Design Raimo Räsänen



3110

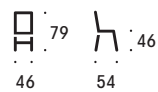

3111

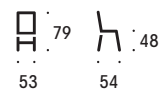

3113

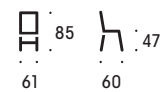

3114

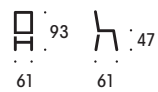

3740

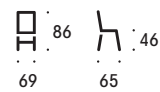

3741

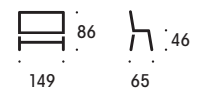

**Taiko**



29640

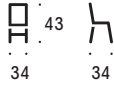

29640

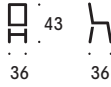

29640

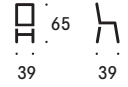

**Roope**

Design Ilari Jääskeläinen



33540

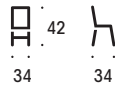

33540

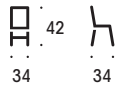

33540

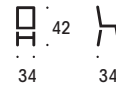

# Kivikko

Design Henri Halla-aho



3748



Height 26 cm

3748



Height 40 cm

3748



Height 54 cm

Available with pads, felt pads or caster wheels.



3749



Top + upholstered footing

3749



Upholstered footing

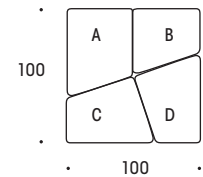
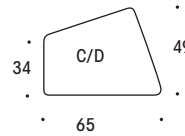
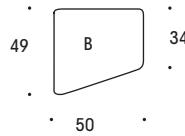
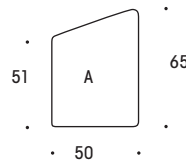

# Noppa

Design Mikko Meriläinen



3756



Height 45 cm

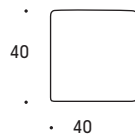

# Amphi

Design Henri Halla-aho



3754



Height 54 cm

3754



Height 40 cm

3754

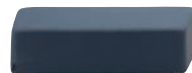

Height 26 cm

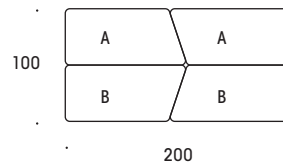
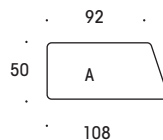

# Mukula

Design Kaija Aalto



The safety distance between a pacemaker and the permanent magnet of a Mukula seat is 10 cm.

3747



Height 7, 16 or 23 cm

3747



Height 7, 16 or 23 cm

3747



Height 7, 16 or 23 cm

3747



Height 7, 16 or 23 cm

3747 Mukula hanging wall element



W84 × D5 × H160  
Picture features three hanging wall elements

# Kaari

Design Henri Halla-aho



3711

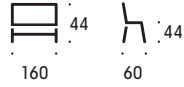

3711

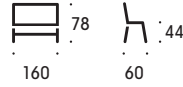

3711

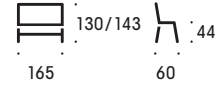

3711

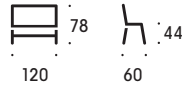

3711

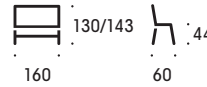

3711

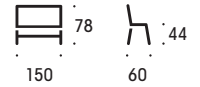

3711

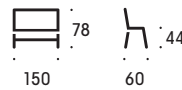

Hook for bags or coats



Drawing board  
W 48, H 56  
W 113, H 89

3711



Divider W 120, H 130



Divider W 120, H 180



Stacked dividers

3711



3711

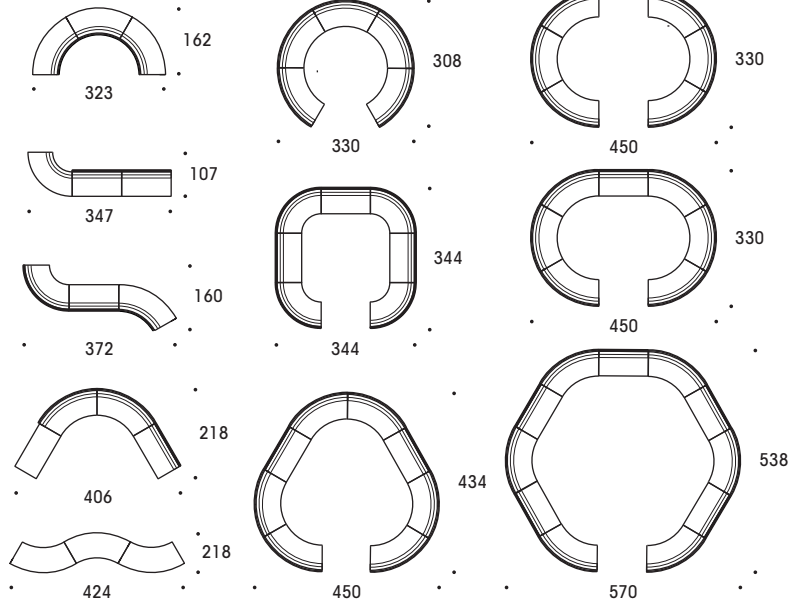

Straight parts

90° parts

60° parts

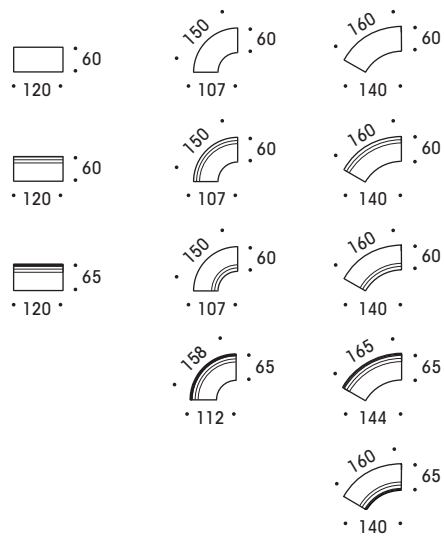

# Syke

Design Mikko Laakkonen



3725

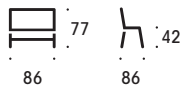

3725

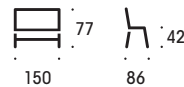

3725

Coffee table

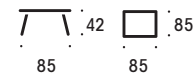

3725

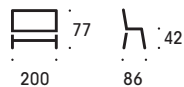

3725

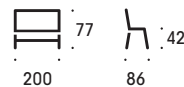

3725

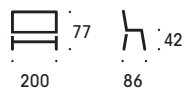



## Inkoo Pro High

Design Ilari Jääskeläinen



3723 1 ½



3723 2 ½



## Inkoo Pro

Design Ilari Jääskeläinen



3722 1 ½



3722 2 ½



3722 3



3722

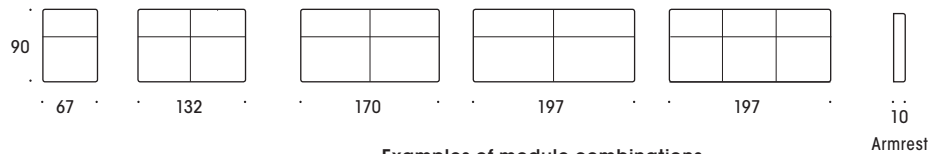

Examples of module combinations

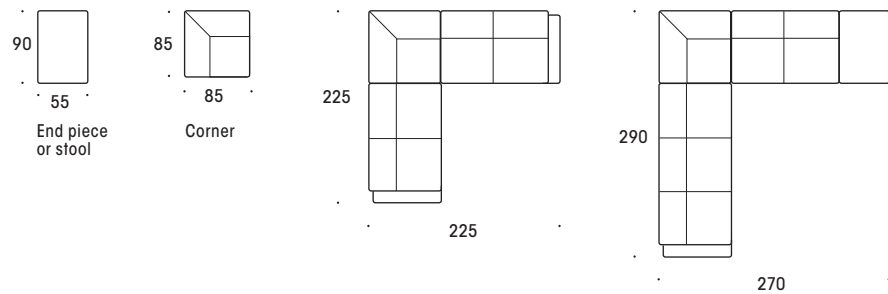

# Tere

Design Antti Olin



3738

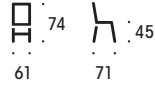

3738

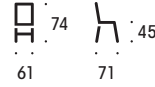

+ Writing pad

3738

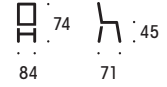

3738

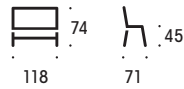

3738

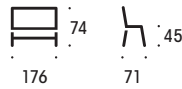

3738

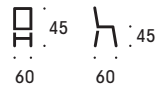

3738

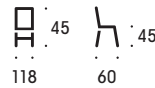

3738

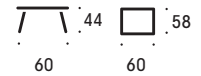

## Dyyni

Design Tapio Anttila



3732

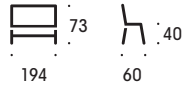

3732

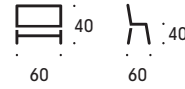

3732

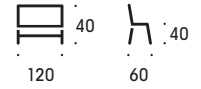

3732

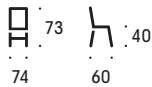

3732

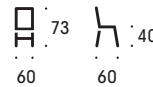

## Sigur

Saara Renvall



3744

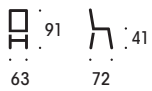

3744

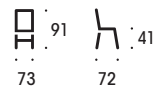

3744

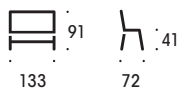

3744

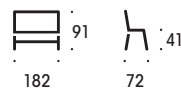

3744

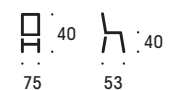

## Duo

Design Antti Olin



Limited selection of upholstery fabrics

3272

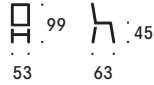

3274

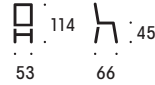

3273

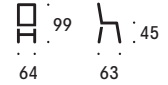

3275

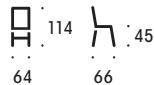

3275

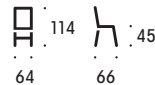

## Duo Lounge

Design Antti Olin



Limited selection of upholstery fabrics

3291

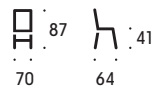

3293

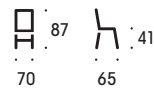

3295

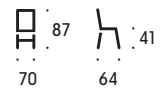

## Metro

Design Kurt Hvitstiö



412

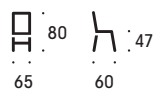

402

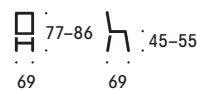

422

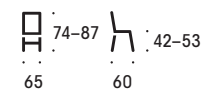

## Big Hug

Design Mika Tolvanen



Limited selection of upholstery fabrics

3726

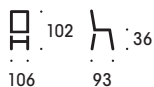

## Concorde

Design Tapani Laukkanen



4901

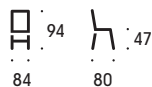

## Rosario

Design Tapani Laukkanen



4896

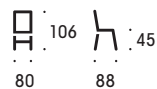

## Organo

Design Raimo Räsänen



3730

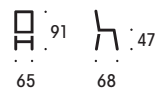

## Flex

Design Tapani Laukkanen



4880

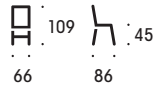

4881

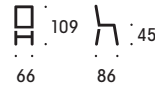

4882

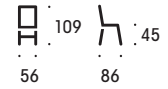

## IKI

Design Ilari Jääskeläinen



See the full IKI product family at [www.isku.com](http://www.isku.com)

5200

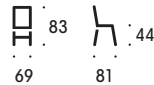

5200

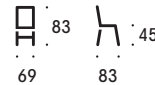

5200

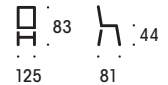

5200

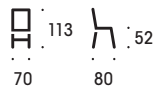

5200

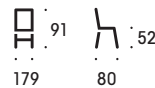

5200

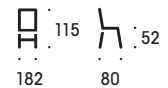

## Aino Pro



3146

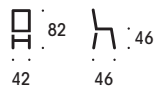

3146

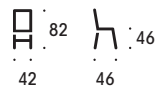

3146

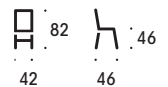

## Alias

Design Raimo Räsänen



3184

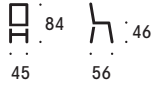

3186

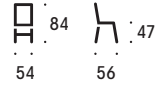

3186 Raised

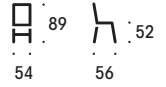

3703

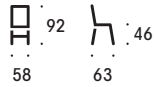

3704

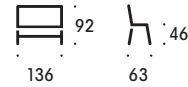

## Aura



3148

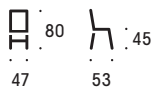

3149

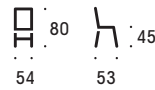

3148

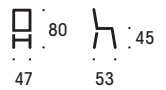

# Time

Design Ilari Jääskeläinen



3540

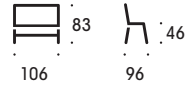

With A armrest

3540



With A armrest

3540

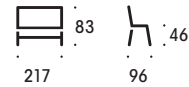

With A armrest

3540

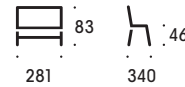

With B armrest

## Modules of Time and Free sofas

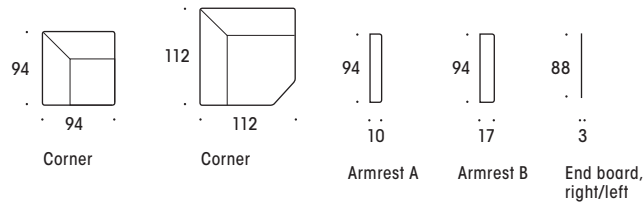
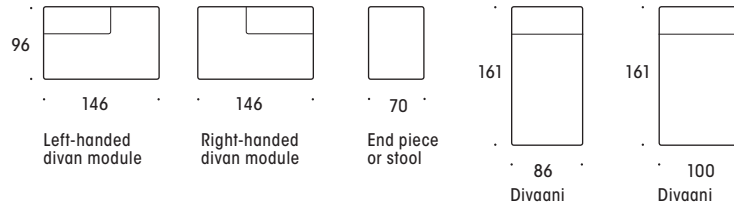
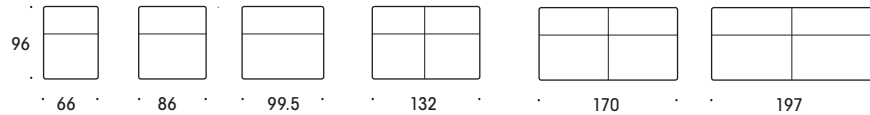



**Free**

Design Ilari Jääskeläinen



3541

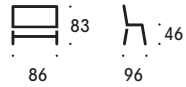

With A armrest

3541

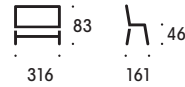

With A armrest

3541

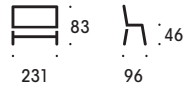

With B armrest

3541

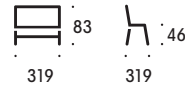

With A armrest

**Examples of combinations of Time and Free sofa modules**

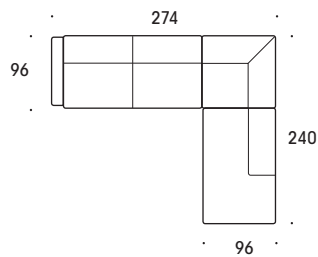
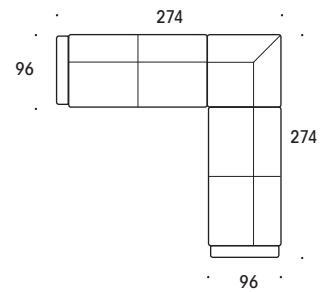
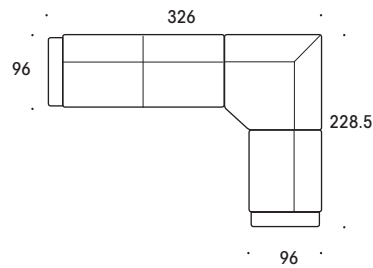

# Casa

Design Ilari Jääskeläinen



3542

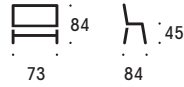

With A armrest

3542

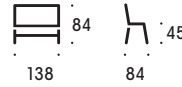

With curved armrest

3542

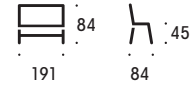

With B armrest

3542

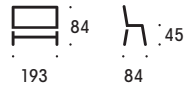

With curved armrest

3542

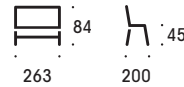

With B armrest

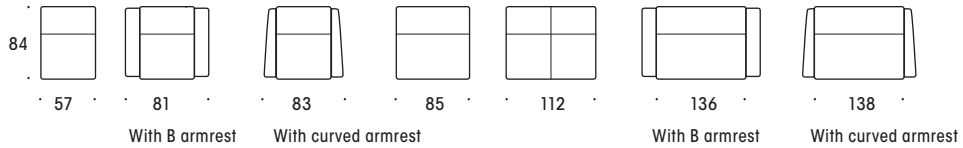

With B armrest

With curved armrest

With B armrest

With curved armrest

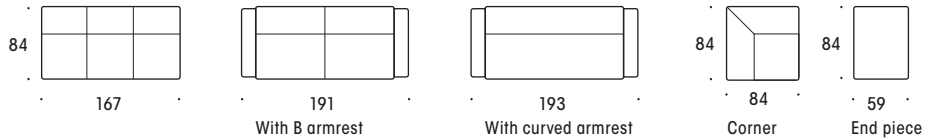

With B armrest

With curved armrest

Corner

End piece

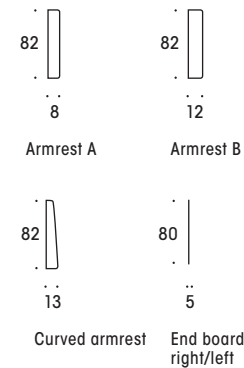

### Examples of module combinations

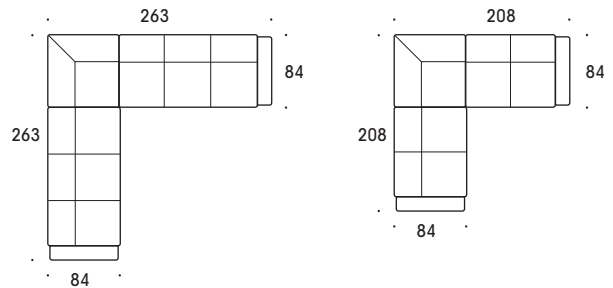

**Diva**

Design Ilari Jääskeläinen



3538

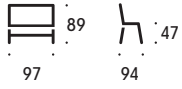

3538

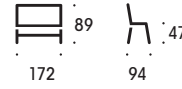

3538

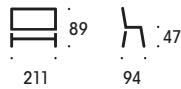

3538

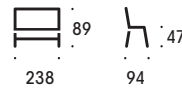

# Geneve Plus Pro

Design Nea Vikström



3712

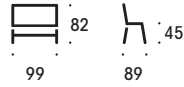

With A armrest

3712

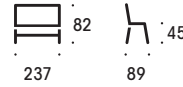

With B armrest

3712

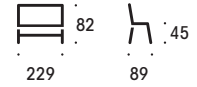

With A armrest

3712

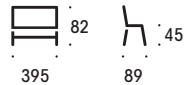

With end board

3712

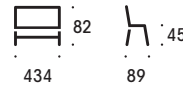

With B armrest



## Examples of module combinations

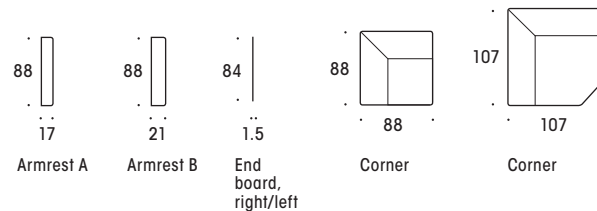
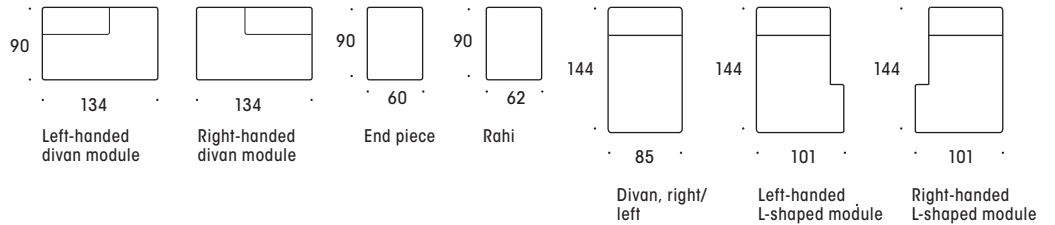
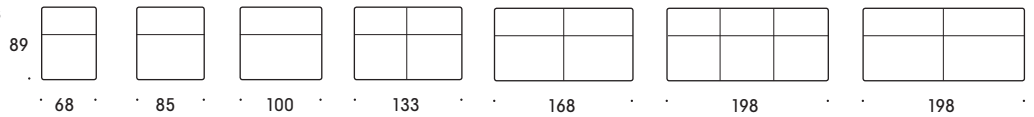
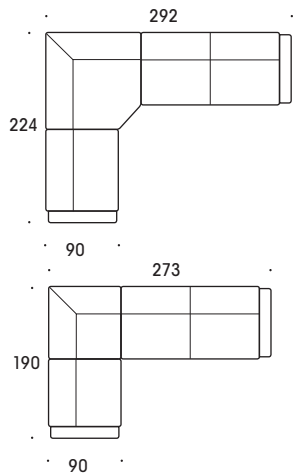

## Giant Donut

29884

Design Ivar Gestranus  
& Kevin Lahtinen

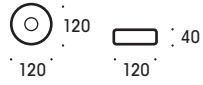

## The Box Lounger

29895

Design Ivar Gestranus  
& Kevin Lahtinen

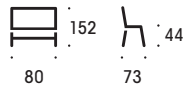

29895

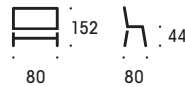

29895

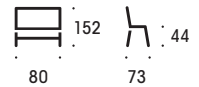



# Tables



## Summa

Design Tapio Anttila



1507 GB

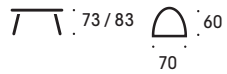

1507 GA

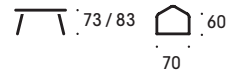

1507 GA

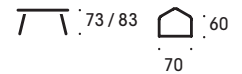

1507 GA

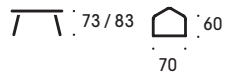

1507 GA

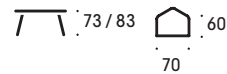

1501 Tabletop C8

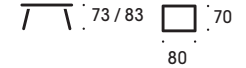

1501 Tabletop C14

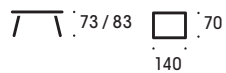

1507 GH

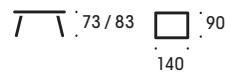

## Mix



1522 Mix 70x50



1522 Mix GA

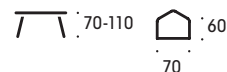



## Pisa desk

Design Desigence



1402



73

1402



73

1401



73

1401



73

1400



73

## Solu

Design Henri Halla-aho



2536



69-109  
46-75

2536



68-108  
46-75

2536



68-108  
46-75

Available in two different height adjustment ranges and three different fixed heights.

Available with two different tops.

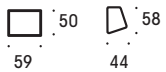

2535



65/73/110

2535



65/73/110

2535



65/73/110

## Prima

Design Raimo Räsänen



1126, 4-6

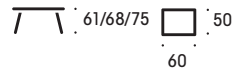

1128, 4-6

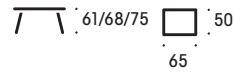

1132, 4-6

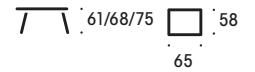

1130, 5-7

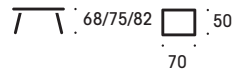

1131, 5-7

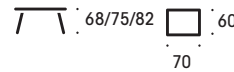

1131, 5-7



## Klik

Design Tapio Anttila



2532 1-h

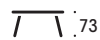

2532 2-h



2551 Klik Pro



2534 Lecture table



2533 Table with folding legs



2531 Stacking lecture table



**Move**



2546 Gas cylinder table



71-112

2545 Table with folding top



73

**Matrix I**

Design Juha Lähti



Manually adjustable table

2057



63-83.5

2058 Tall



80-100.5

**Matrix Y**

Design Juha Lähti



2110



73

2111



90

## Osio

Design Tapio Anttila



2526



2526



2527



## Dio



29071



29072



29073



## Scan



29057 All-purpose table



29057 Height-adjustable table



29057 Standing table



## Moni



2523



2521



### 7303



7303



### Haiku

Design Tapio Anttila



7310



7311 Raised all-purpose table



## Isku Easy T EL



Electric adjustable table

After installation, cables can be hidden inside the frame rail; no need to use tools or fasteners.

2061



2061 Available with battery



## Isku Style T EL



Electric adjustable table

2061



2061



2063



## Isku Classic T EL



Electric adjustable table

2061



## Matrix T manual



Manually adjustable table

2056



2056



# Stone

Design design Vertti Kivi & Co



2840 Workstation

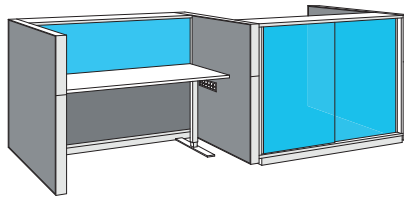

2810 Sliding door cabinet

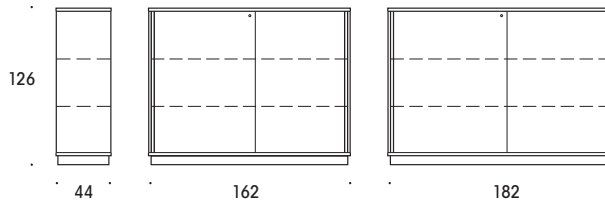

2810 Storage tower

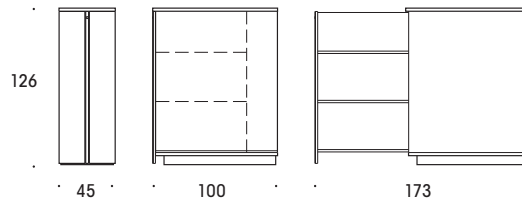

2061 Desk

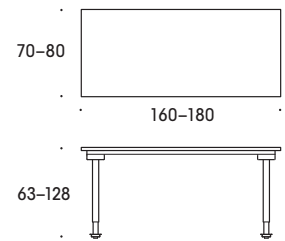

2840 Divider

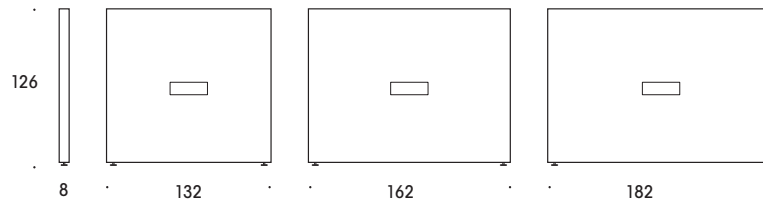

## Matrix T EL Pro



2063



73-138

## Matrix T manual



2056



66-81

## Osio

Design Tapio Anttila



2526 T base



73

## Dio



29072



73



## Kantti

Design Tapio Anttila



7308

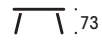

## Oksa

Design Ilari Jääskeläinen



2555



2555



2556



## Option

Design Antti Kotilainen



2400

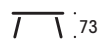

2400

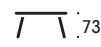

## Ant



2500



## Osio coffee table

Design Tapio Anttila



2525



2525



2525



## Sigur coffee table

Design Saara Renvall



3745



3745



3745



See Sigur chairs on p. 127

## Kivikko table

Design Henri Halla-aho



3753



3753



See Kivikko seats on p. 132

## XO coffee table

Design Antti Kotilainen



7110



7110



### Poiju

Design Henri Halla-aho



3757



45 Ø90

### Swing coffee table

7144



50

### Scan coffee table

29057



55

### 7003 coffee table

7003



52

### Diva coffee table

31087



38 Ø70

31087



38 57 97

31087



45 65 115 115

### Haiku coffee table

Design Tapio Anttila



7312



52

7313 Raised coffee table



65



# Storage



# Tendo

Design Juha Lähti



22773 Storage tower



22773 Double-faced storage tower



2753 Sliding door cabinet, 120 cm



2753 Sliding door cabinet, 80 cm



2752 Sliding door cabinet, 120 cm



2743 Horizontal roll door cabinet



2723 Roll door cabinet + top shelf



2742 Horizontal roll door cabinet, 120 cm



2724 Roll door cabinet



2715 Cabinet with doors



2715 Shelf



## Tendo Oppi

Design Juha Lähti & Antti Olin



1451 4D



1453 6G



1453 6J



1453 6E



1451 6Q



1455 6S



## Tendo Mobili Tendo AV



2732 Mobili



2733+B6 AV



## Accessories

2790-575 Pigeonholes



2790-520 Accessory drawer with insert



2793-500 Set of boxes with self-contained frame

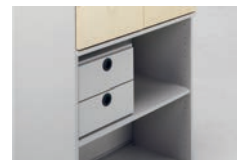





Key

- ◻ Storage unit also available with feet or castor wheels
- ◻ Storage unit also available with feet

The width of the cabinets is 80 cm, unless otherwise indicated.

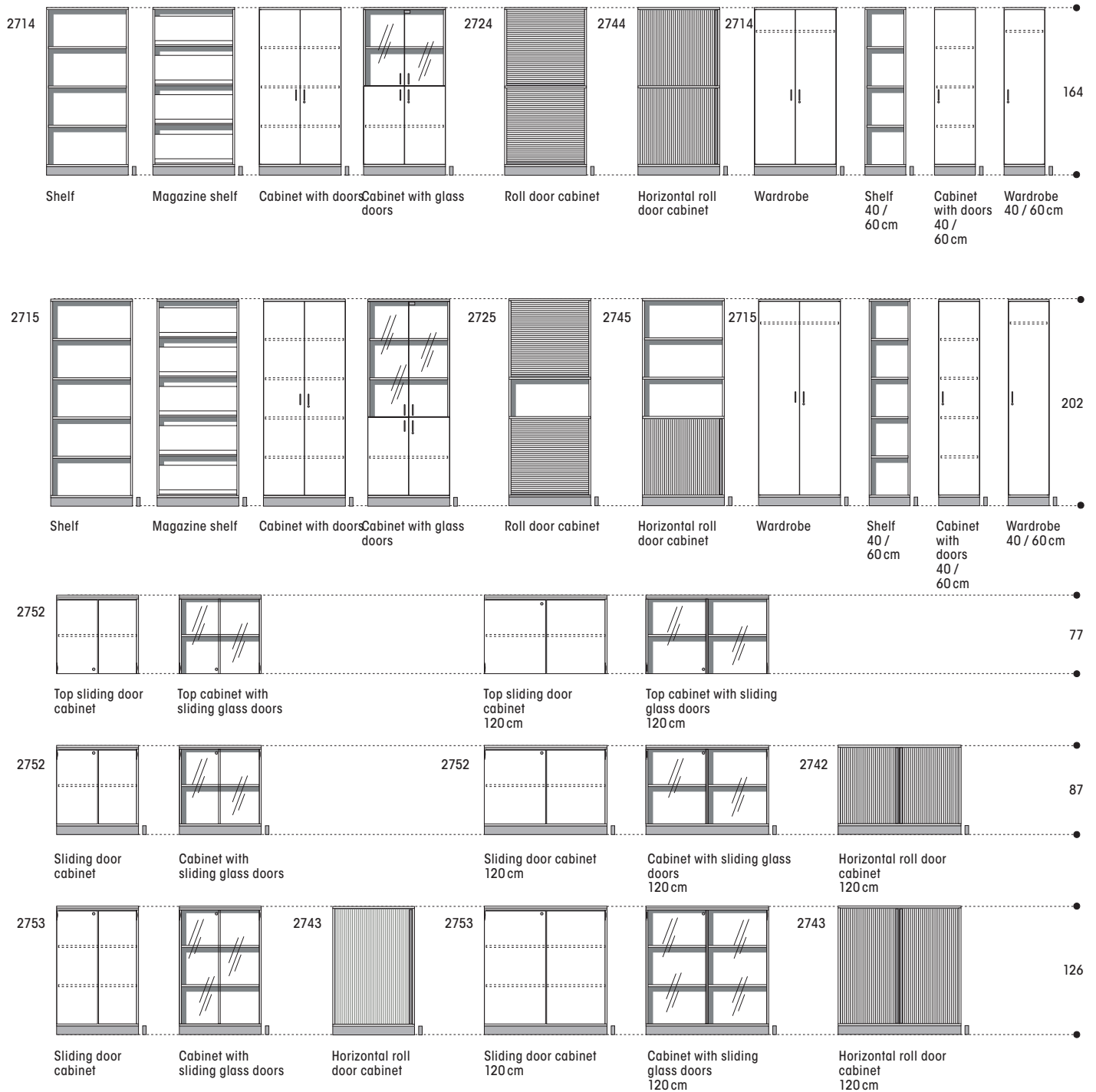

# Vakio

Design Juri Karinen



2708

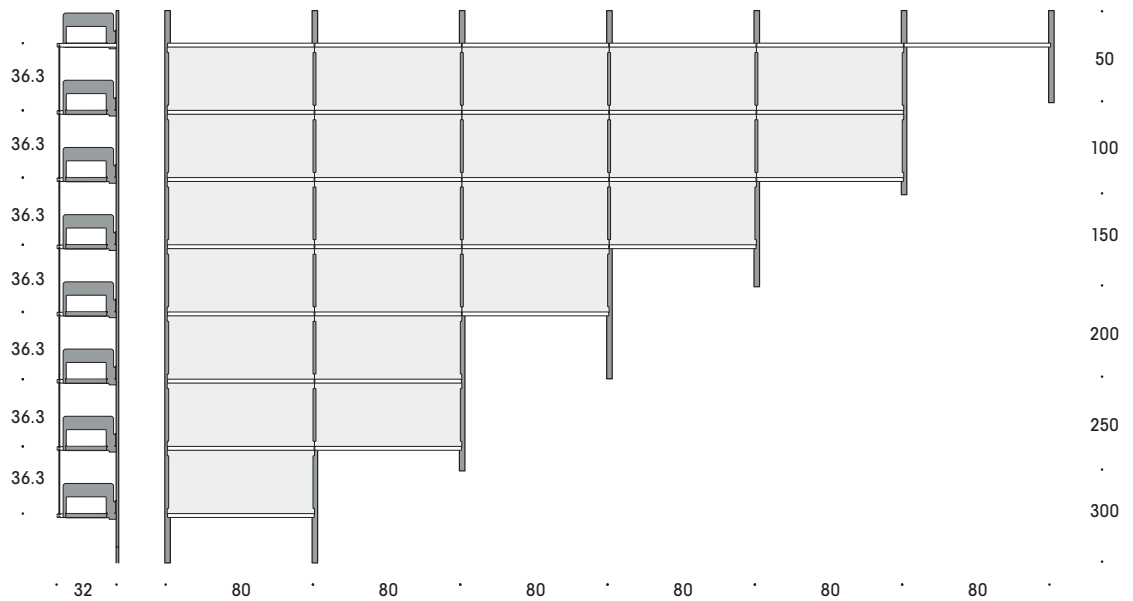

### Doors

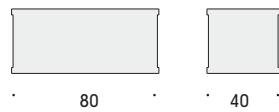

# Ark

Design Henri Halla-aho



2700-



## Modules

60 cm deep cabinets

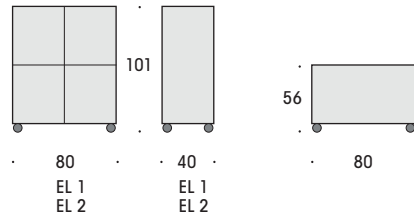
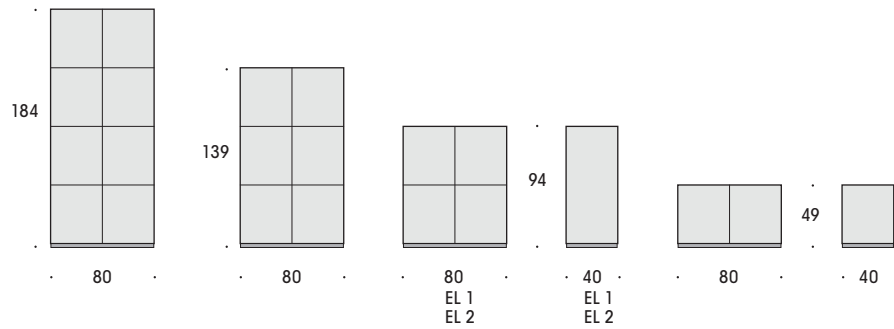

## Additional features

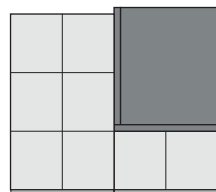

Upholstered seats, backs and sides

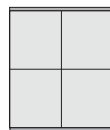

Extra top

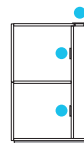

EL1

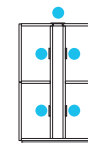

EL2

Modules available as one- or two-sided

EL = Available with charging sockets

● Socket

# Fuuga

Design Helorinne & Kallio



Examples of modules

29550 Open module



29550 Open module + shelf



29550 Door module with 2 doors



29550 Door module with 4 doors



29550 Drawer module with 2 drawers



29550 Drawer module with 1 drawer



29550 Door module with 2 doors



+ Bend legs, 26 cm

29550 Door module with 2 doors



+ String legs, 26 cm

29550 Door module with 2 doors



+ Groove legs, 10 cm

29550 Door module with 2 doors



+ Groove legs, 26 cm

Open modules with depth of 32 cm

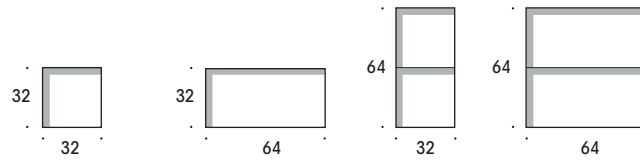

Door modules with depth of 32 cm

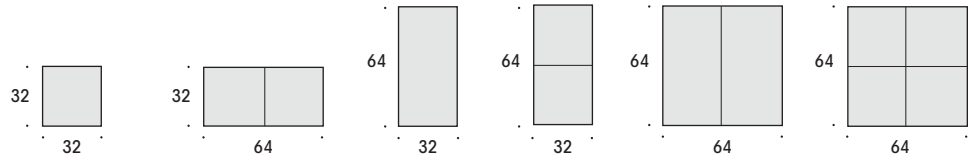

Open modules with depth of 45 cm

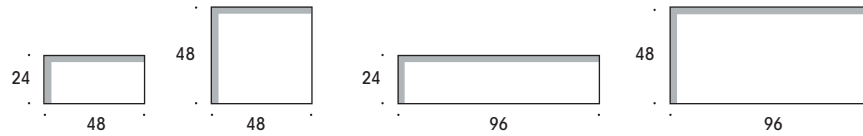

Door modules with depth of 45 cm

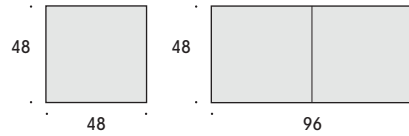

Drawer modules with depth of 45 cm

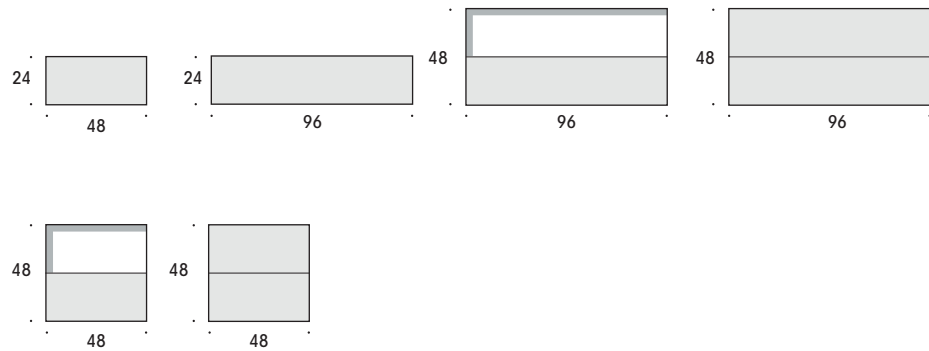

Modules also available  
with 26 cm or 10 cm legs.





# Dividers

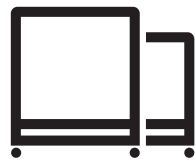

## Kaari divider

Design Henri Halla-aho



3711



Divider W 120, H 130



Divider W 120, H 180



Caster wheel leg for dividers

3711



Divider leg



Hook for bags or coats



Drawing board  
W 48, H 56  
W 113, H 89

## Mode dividers and front panels

Design Juha Lähti & Juri Karinen



2836 Mode white front panel

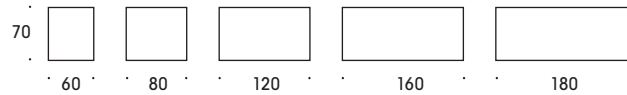

Panel thickness 1.6 cm

2836 Mode upholstered front panel

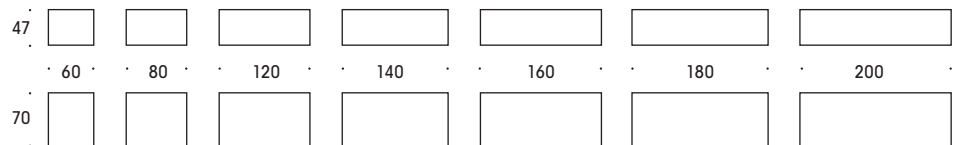

Panel thickness 2 cm



2836 Mode Akusto panel



With D fastener

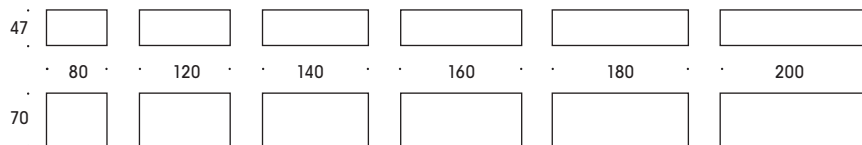

Panel thickness 4 cm

2831 Mode Akusto divider with feet



2831 Mode Akusto divider with feet



Colour options for Mode Akusto feet:

- graphite
- silver
- white
- black

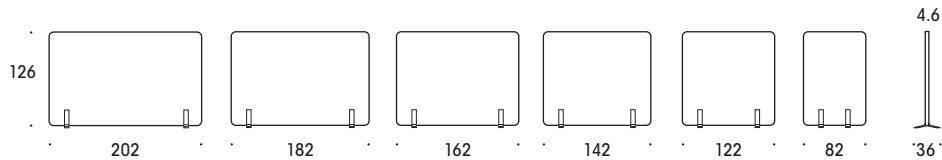

2831 Mode Akusto divider with wheels



Colour options for wheeled Mode Akusto feet:

- graphite / black wheels
- silver / light grey wheels
- white / white wheels
- black / black wheels

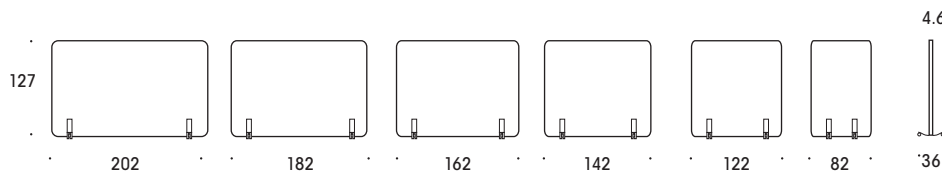

Mode Akusto divider and panel system uses connecting fixtures T, L and X; the divider ends have Velcro tape fastening.

# Link Line

Design Raimo Räsänen



2828



2829

Link Line Akusto



## Link Line 2828 and Link Line Akusto 2829

Top elements



Middle elements



Bottom elements



M, N = fabric, P = glass  
Divider thickness 6 cm

# Link

Design Raimo Räsänen



2824



2824



2825



## Combination options of the bottom, top and window elements of Link dividers

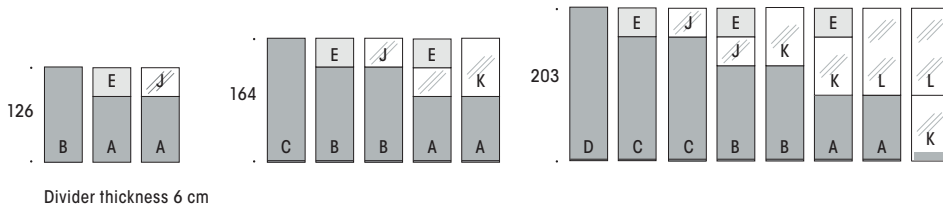

## 2823 Link door

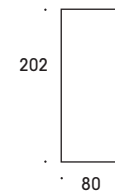

## Link bottom elements A-D

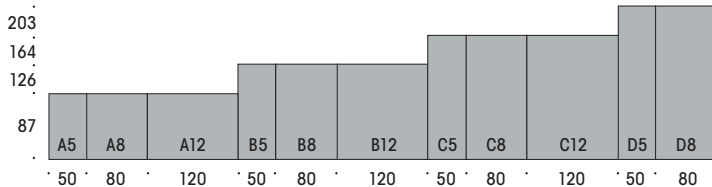

## Link top element E

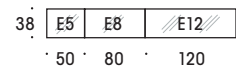

## Link window elements J-L

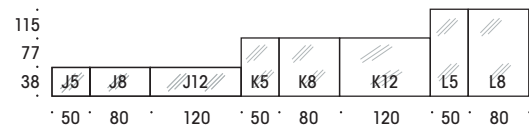

## Air



2821

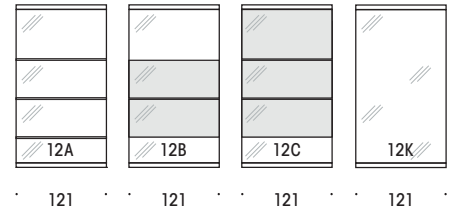
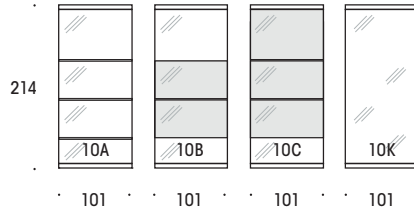
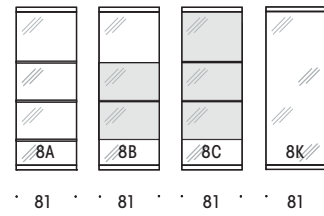
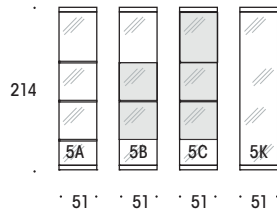

## Framery O



29920



W 100, D 100, H 221

## Framery Q



29921



W 220, D 120, H 221

## Woodland

Design Ivar Gestranus & Kevin Lahtinen



29898

High

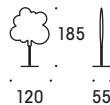

29898

Low



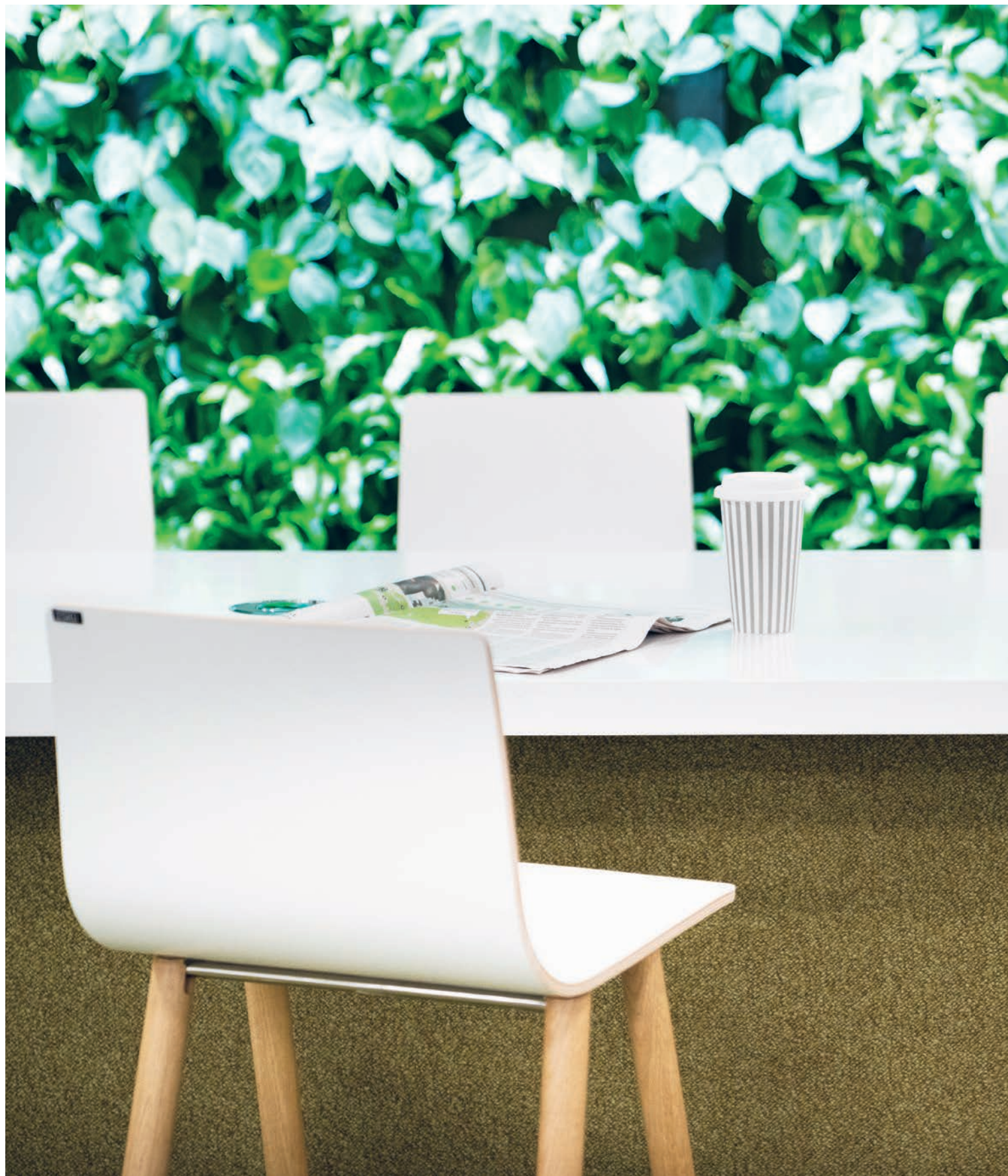



# Accessories and decor



## Desk accessories



**Mona monitor arm 29038**

- silver
  - white
- Capacity 2–10 kg



Pictured: 29039  
1 x schuko, 4 x cable penetration ■ black

**Powerdot satellite 29039**

- 1 x schuko, 4 x cable penetration ■ black
- 1 x schuko, 4 x cable penetration □ white
- 1 x schuko, 4 x cable penetration, adjustable ■ black
- 1 x schuko, 1 x data socket, 1 x USB charger, adjustable ■ black
- 1 x schuko, 1 x data socket, 1 x USB charger, adjustable □ white
- 1 x schuko, 1 x HDMI, 1 x USB port, adjustable ■ black

Also available with UK power socket.

### Powerdot accessories

For models 20939

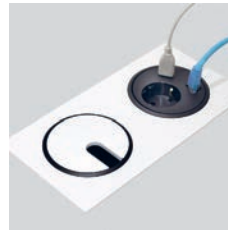

**Metallic cover 29039**

- silver
- white
- black

### Metallic frames 29039

- silver
- white
- black

Frame for one Powerdot

- silver
- white
- black

Frame for two Powerdots

- silver
- white
- black

Frame for four Powerdots

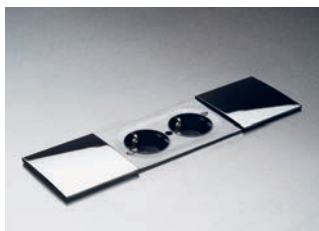

Pictured 29038 2 x schuko ■ black

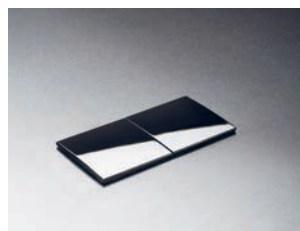

**Due power socket unit**

Available with  
2 x schuko

- RST
- white
- musta



Pictured: 29038 1 x schuko ■ stainless steel

**Pix power socket**

Available with  
1 x schuko  
1 x UK power socket  
1 x HDMI  
1 x USB charger

- stainless steel
- white
- black



Pictured: 29045  
4 x schuko, 4 x net, VGA, USB, audio, HDMI  
■ brushed stainless steel

**Bi-Box modular power socket**



**Bi-Box2** 29045 3 x schuko, 2 x net



**Bi-Box3** 29045 2 x schuko, net, VGA, audio, HDMI



**Bi-Box4** 29045 4 x schuko, 4 x net, 4 x USB



**Bi-Box5** 29045 4 x schuko, net, VGA, audio, HDMI



**Bi-Box6** 29045 4 x schuko, 4 x net, VGA, USB, audio, HDMI

**Bi-Box covers for short cable door**

- 29045
- brushed stainless steel
  - white

**Bi-Box covers for long cable door**

- 29045
- brushed stainless steel
  - white



Pictured: 29038  
2 × schuko + USB charger ■ silver

### Power Frame modular power socket

Available with  
 2 × schuko + RJ45  
 2 × UK power socket + RJ45  
 2 × schuko + HDMI  
 2 × UK power socket + HDMI  
 2 × schuko + USB charger

■ silver  
 □ white  
 ■ black



Pictured: 29038  
2 × schuko + RJ45 ■ silver

### Power Frame Cover modular power socket

Available with  
 2 × schuko + RJ45  
 2 × UK power socket + RJ45  
 2 × schuko + HDMI  
 2 × UK power socket + HDMI  
 2 × schuko + USB charger

■ silver  
 □ white  
 ■ black



### Socket column 29030

2 × 4 schukos, 2 × RJ45 □ white  
 2 × 4 schukos, 4 × RJ45 □ white  
 2 × 4 schukos, 2 × RJ45 L □ white  
 2 × 4 schukos, 4 × RJ45 L □ white  
 2 × 4 schukos, 2 × RJ45 T / 120° □ white  
 2 × 4 schukos, 4 × RJ45 T / 120° □ white  
 2 × 4 schukos, 2 × RJ45 X □ white  
 2 × 4 schukos, 4 × RJ45 X □ white

Available as freely standing columns with integrated base, or as part of Link or Link Line divider systems.



## Standing mat



### Balance Spot standing mat 35050

■ grey  
■ dark grey  
64×46×3 cm

## Organiser



### R-Eco organiser 29028

3 waterproof baskets  
43×30×45 cm

## Service desk



### Reception counter 2095

The Reception counter can be assembled in a variety of configurations. Combine different sitting and standing height counters to create your perfect ergonomic design. The standard model comes with glass front panels. Desks are placed inside the counter. Isku's experts will help in designing your personal counter unit.

## Lighting



### LED Disonic desk lamp 29035

- white
- black

Comes with USB charging, automatic power cut-off, 5-step brightness adjustment and colour temperature adjustment.



### Valovoima bright light lamp 29036

- white

Design Harri Koskinen

57.5 x 50 cm

LED desk lamp / certified bright light lamp with dimmer, 4000K, aluminium frame.



### Level S and L acoustic pendant lamp 29036

- (Level S)  grey
- (Level L)  grey

Design Muotohiomo

36 x 29 x 50 cm (S)

100 x 15 x 50 cm (L)

LED, 4000K, acoustic felt material 100% recycled PET; L size doubles as a space divider.



### Fiber 900 and 1200 pendant lights 29036

- (Fiber 900)  grey
- (Fiber 1200)  grey

Design Lars Vejen

14 x 88 x 6 cm (900)

14 x 118 x 6 cm (1200)

LED, 4000K, fibre cement and white acrylic.



### Diamond pendant lamp 34836

- Ø42 cm  opal
- Ø60 cm  opal

Design Jonas Hakaniemi



### Laskos pendant lamp 34836

- opal
- creme
- black

Design Kristiina Lassus

Ø33 cm



### Lootus pendant lamp 34836

- opal
- grey
- lilac
- brown

Design Jukka Korpihete

Ø62 cm

**Loisto table lamp 29551**

- white
- green / white
- grey / white

Design Jukka Korpihete  
 Height 54.5 cm, stand Ø 17.2 cm, shade  
 Ø 28.5 cm

**Soihitu table lamp 29551**

- white
- black
- sand

Design Jukka Korpihete  
 25 x 30 x 50 cm

**Soihitu floor lamp 29551**

- white
- black
- sand

Design Jukka Korpihete  
 73 x 50 x 180 cm

**Halo Small ceiling lamp 29551**

- white
- black
- sand

Design Jukka Korpihete  
 Height 25.5 cm, Ø 70 cm

**Halo Large ceiling lamp 29551**

- white
- black
- sand

Design Jukka Korpihete  
 Height 22.5 cm, Ø 100 cm

**Tip pendant lamp 29036**

- Ø40 cm  white
- Ø40 cm  black and white
- Ø60 cm  white
- Ø60 cm  black and white

Design Tapio Anttila  
 LED, 4000K, acrylic.

**Tip floor lamp 29036**

- Ø60 cm  white
- Design Tapio Anttila  
 LED, 4000K, acrylic.

## Roller



**29025**  
3 baskets  
L 108 S 67 K 129 cm

## Coat racks



**Post rack**  
29021  
Design Mikko Laakkonen  
Metal. Colours: silver, graphite, white, green, black



**Arctic rack**  
29020  
Design Ismo Mankonen  
Metal. Colours: silver / black, graphite / black



**Lotus rack**  
33524  
Metal. Rotating top.  
Colours: silver, graphite



**Lobby coat rack system**  
29022  
Design Jukka Setälä  
90/120×40/60×190 cm  
Colours: birch, grey



**Lobby Tech coat rack system**  
29023  
Design Jukka Setälä  
90/120×40/55×190 cm  
Metal and glass. Colour: light grey

## Writing boards



**Mood Wall**  
29693  
100×100, 150×100, 200×100 cm, white and coloured. With magnetic glass surface.



**Mood Flow Mobile**  
29693  
Design Christian Halleröd  
65×19.6 cm, white and coloured. With magnetic glass surface.

## Carpets

Shape of size S



**pOmpUp carpet 35000**

pOmpUp ORIGINAL  
pOmpUp ORIGINAL ENTRANCE  
black / melange, grey / melange,  
brown / melange.

Shape of size M



pOmpUp EXCLUSIVE  
pOmpUp EXCLUSIVE ENTRANCE

90 × 47 (S), 122 × 62 (M),  
193 × 97 cm (L), red, black, dark grey,  
light grey.

Shape of size L



Entrance shape



pOmpUp SUPER  
pOmpUp SUPER ENTRANCE

90 × 47 (S), 122 × 62 (M),  
193 × 97 cm (L), available in the  
extensive range of colours of the  
made-to-order collection.

Shape of size S



**OCTA S carpet 35000**

EXCLUSIVE 90x180 cm  
red, black, dark grey, light grey

SUPER 90x180 cm  
available in the extensive range of colours of  
the made-to-order collection

Shape of size M+



**OCTA M+ carpet 35000**

EXCLUSIVE 130x325 cm  
red, black, dark grey, light grey

SUPER 130x325 cm  
available in the extensive range of  
colours of the made-to-order collection

Shape of size L



**OCTA L carpet 35000**

EXCLUSIVE 190x190 cm  
red, black, dark grey, light grey

SUPER 190x190 cm  
available in the extensive range of  
colours of the made-to-order collection



**tWIN A carpet 35000**

EXCLUSIVE 350 × 195 cm, red, black, dark  
grey, light grey

SUPER 350 × 195 cm, available in the  
extensive range of colours of the made-to-  
order collection.



**tWIN B carpet 35000**

EXCLUSIVE 195 × 115 cm, red, black, dark  
grey, light grey

SUPER 195 × 115 cm, available in the  
extensive range of colours of the made-to-  
order collection.



**GO outdoor carpet 35000**

CIRCLE S 100 × 100 cm  
CIRCLE L 180 × 180 cm

SEMI-CIRCLE S 50 × 100 cm  
SEMI-CIRCLE L 90 × 180 cm

Extensive range of colours (17 colours).

## Acoustic elements



**Duo 35010**

INNOturf SMARTpackDUO

Ø 25 × 0.2 (XS), Ø 33 × 0.2 (S), Ø 40 × 0.2 (M)  
and Ø 59 × 0.2 mm (L), black, white, custom  
colour or print.



**Mind 35010**

INNOturf SMARTpackMIND

Ø 40 × 0.2 (M) and Ø 59 × 0.2 mm (L), black,  
white, natural and custom colour.

## Silk plants



### Cypress 170 cm\* 29696

Cubico pot  white  
Cubico pot  dark grey

Pot height 75 cm, plant height 140 cm, total height approx. 170 cm



### Buxus cone 150 cm\* 29696

Cubico pot  white  
Cubico pot  dark grey

Pot height 56 cm, plant height 125 cm, total height approx. 150 cm



### Round buxus 125 cm\* 29696

Cubico pot  white  
Cubico pot  dark grey

Pot height 75 cm, plant height 50 cm, total height approx. 125 cm



### Round thuja 125 cm\* 29696

Cubico pot  white  
Cubico pot  dark grey

Pot height 75 cm, plant height 50 cm, total height approx. 125 cm



### Decorative grass 150 cm 29696

Cubico pot  white  
Cubico pot  silver  
Cubico pot  black  
Cubico pot  graphite grey

Pot height 56 cm, plant height 130 cm, total height approx. 150 cm



### Spear sansevieria 110 cm 29696

Cylindrus pot  white  
Cylindrus pot  black  
Cylindrus pot  graphite grey

Pot height 43 cm, plant height 95 cm, total height approx. 110 cm

## Indoor plants



### Mother-in-law's tongues 110 cm 29696

Pure Square Divider  white  
Pure Square Divider  dark grey

Pot height 80 cm, plant height 70 cm, total height approx. 110 cm



**Rubber tree 220 cm 29696**

- Cubico pot  white  
 Cubico pot  silver  
 Cubico pot  black  
 Cubico pot  graphite grey

Pot height 75 cm, plant height 170 cm, total height approx. 220 cm



**Rubber tree 200 cm 29696**

- Cubico pot  white  
 Cubico pot  silver  
 Cubico pot  black  
 Cubico pot  graphite grey

Pot height 56 cm, plant height 170 cm, total height approx. 200 cm

## Trees



**Zamioculcas 65 cm 29696**

- Quadro pot  white  
 Quadro pot  silver  
 Quadro pot  black  
 Quadro pot  graphite grey

Pot height 21 cm, plant height 55 cm, total height approx. 65 cm



**Mother-in-law's tongues 55 cm 29696**

- Balconera pot  white  
 Balconera pot  dark grey

Pot height 19 cm, plant height 45 cm, total height approx. 55 cm

## Low potted plants



**Agave 55 cm 29696**

- Quadro pot  white  
 Quadro pot  silver  
 Quadro pot  black  
 Quadro pot  graphite grey

Pot height 21 cm, plant height 45 cm, total height approx. 55 cm



**Mother-in-law's tongues 50 cm 29696**

- Quadro pot  white  
 Quadro pot  silver  
 Quadro pot  black  
 Quadro pot  graphite grey

Pot height 21 cm, plant height 45 cm, total height approx. 50 cm



**Decorative grass 40 cm 29696**

- Balconera pot  white  
 Balconera pot  dark grey

Pot height 19 cm, plant height 30 cm, total height approx. 40 cm







## Materials

Today, interior decoration is part of the business identity. With the right material choices, it is possible to turn any room into a personalised, inviting calling card for the business.

Wear resistance, easy maintenance and safety regulations must be considered when selecting furniture and materials for public spaces.

At its best, an inspiring and effective design of decor and materials of facilities will have a positive impact on staff well-being and performance. A well-designed space makes a positive difference.

Find our extensive selection of standard materials at [www.isku.com](http://www.isku.com)

**kvadrat**

**Lauritzon's®**

**camira**

**Gabriel®**

## Symbols

### Materials

The materials available for a product are indicated with the symbols listed below. The material can be available for one or more products in the product family.



Solid wood  
Varnished, stained  
or painted



Veneer  
Varnished,  
stained or  
painted



Laminate



Leather



Textile



Plastic



Metal frame



Recycled materials



Glass



Available with  
antimicrobial  
materials



Wood-plastic  
composite

### Additional features

Additional features available for a product are indicated with the symbols listed below. The feature can be available for one or more products in the product family.



Available with  
casters or rollers



Available as  
stacked version



Available as  
stacked version



Available with  
removable or  
replaceable  
covers



Available as raised  
version or with height  
adjustment



Available with  
rocking mechanism



Available with  
wheelchair  
dimensions



Available with power  
sockets

### Dimensions

The dimensions are given in centimetres (cm) as width (W), depth (D) and height (H) or with the symbols listed below.

#### Seats and chairs

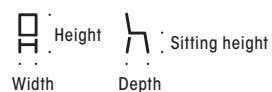

#### Tables



### Antimicrobial materials

Antimicrobial materials based on silver and copper help to eliminate microbes and reduce the transmission of microbial pathogens through contact surfaces. Antimicrobial furniture is ideal for all public spaces with an elevated risk of infection, such as healthcare facilities, care homes, kindergartens, schools and communal spaces at offices.

Read more about the design of hygienic interiors in RT Building Information Files RT 91-11250 and RT 91-11249.

 Products marked with this symbol are available with antimicrobial metal, upholstery and wood materials. Antimicrobial properties last throughout the products' service life.

### Upholstery

**For removable or replaceable covers, we recommend the laminated fabric in the Gabriel Step collection, available in 12 standard colours. The fabric withstands industrial laundering.**

For fully antimicrobial fixed upholstery, we recommend Camira Halcyon fabrics.

Products for environments with no special

requirements on the fabric can be upholstered with any upholstery fabric in Isku's fabric range.

### Wood and veneers

**Standard solid wood and veneer varieties are birch, beech and oak. As a standard, veneer is attached on beech with stain. (For the wood varieties available for a given products, see the product card)**

### Laminates

**Our standard laminate range has 13 patterns plus a selection of antimicrobial laminates. Both are available with ABS or cast edges (For the availability of cast edges for a given product, see the product card).**

### Metals

**In addition to the standard colours, special colours according to the customer specification are available as a special delivery. (For the standard colours available for a given product, see the product card.)**

### Warranty

No implicit guarantee is granted for fabrics or surface treatments that do not belong to our standard range.

# Standard desktops and table tops

The tops are made of 26 mm thick furniture board or MDF. Asymmetrical tops are shown as left-handed versions. All tops are also available as right-hand versions. The beech veneered tops can be stained with Isku's standard furniture stains. Veneered EL and P table tops are made of MDF board with bevelled edges. Laminate 215 and laminate 230 EL and P table tops have ABS edging strips. Some table tops are available with laser edging strips.

## Antimicrobial table tops

All table tops can be manufactured with antimicrobial surfaces.

☛ Antimicrobial standard table tops. Tops are 26 mm thick laminated or brass surfaces with cast edges.

↔ Direction of the veneer in veneered- - - Bevelled edge tops

### Edge options

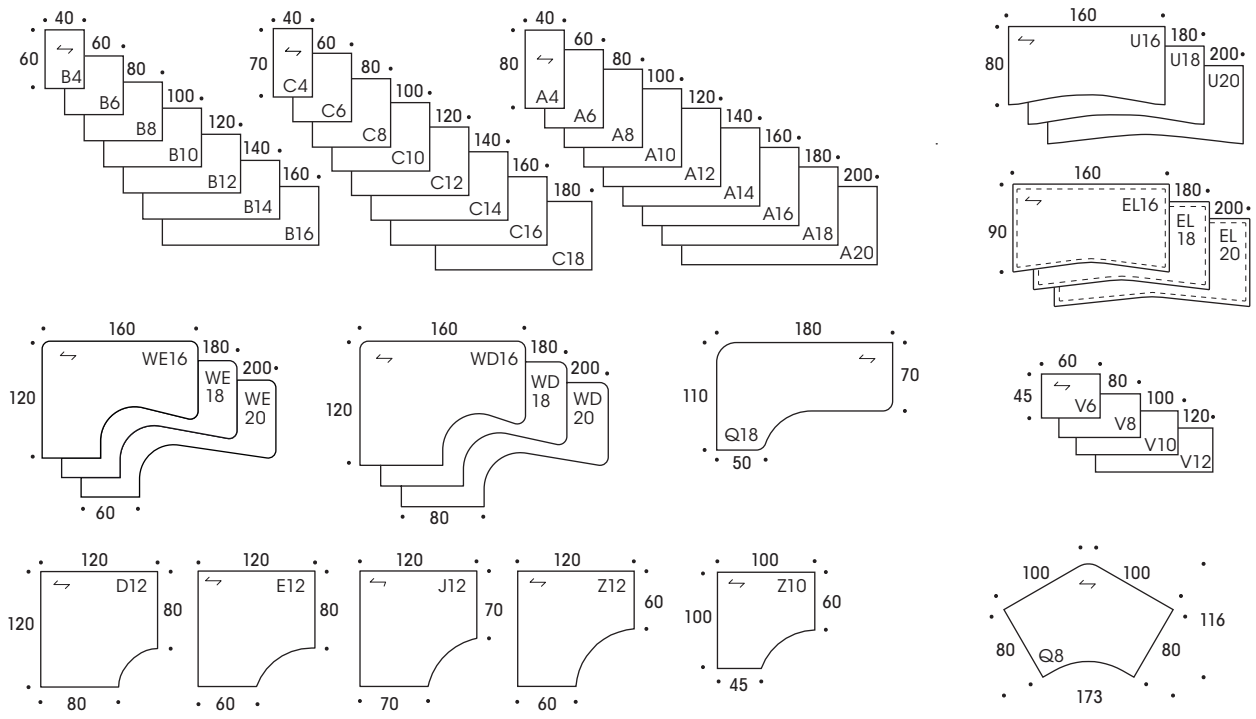
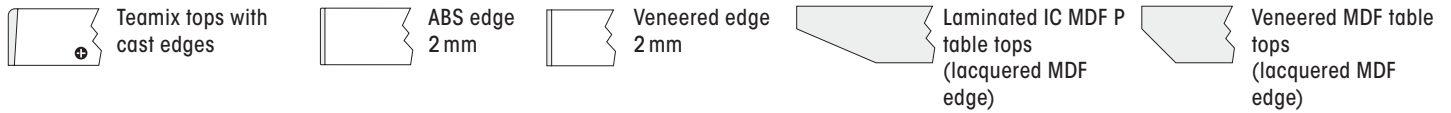

### Tops for teamwork desks

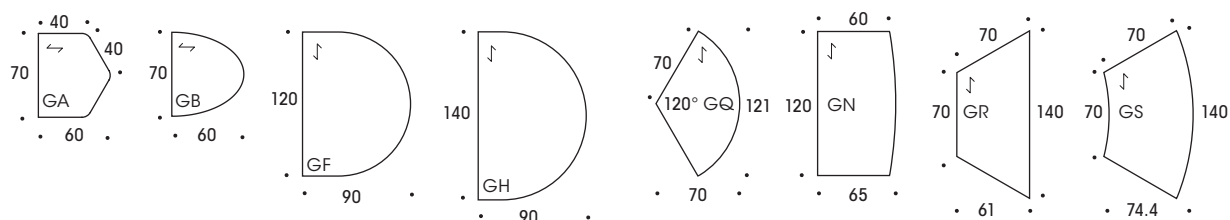

Round and oval tops

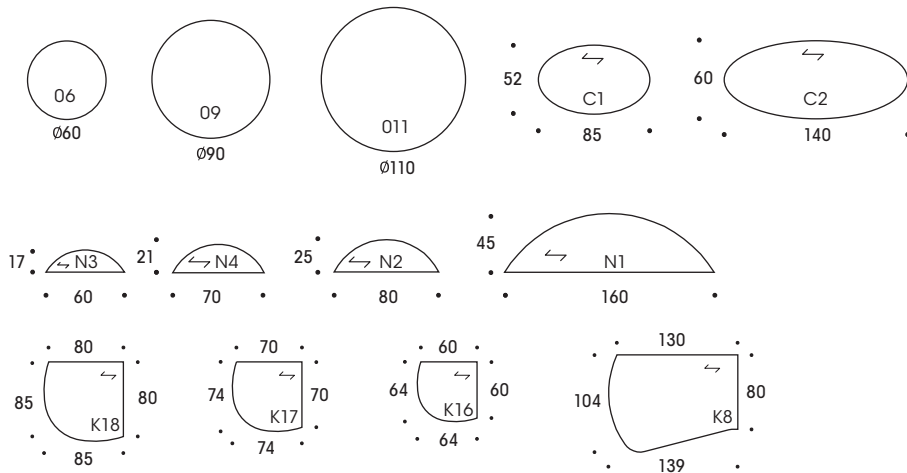

Conference table tops

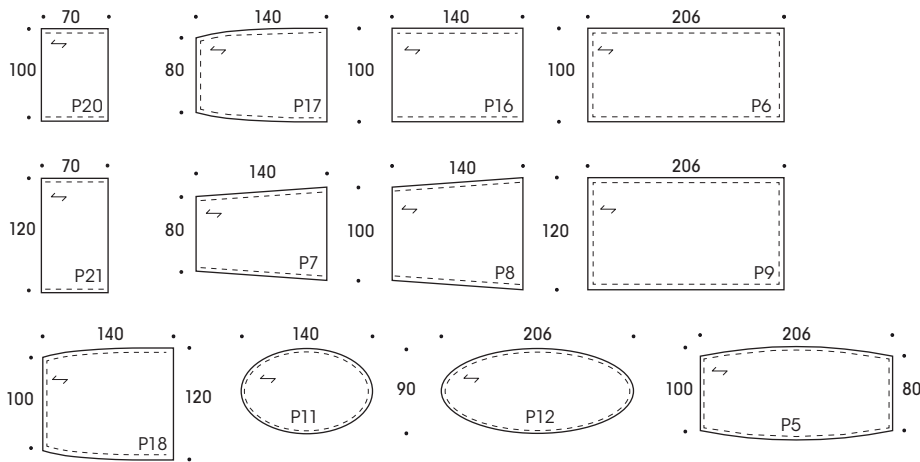

⊕ Tops with cast edges (Teamix)

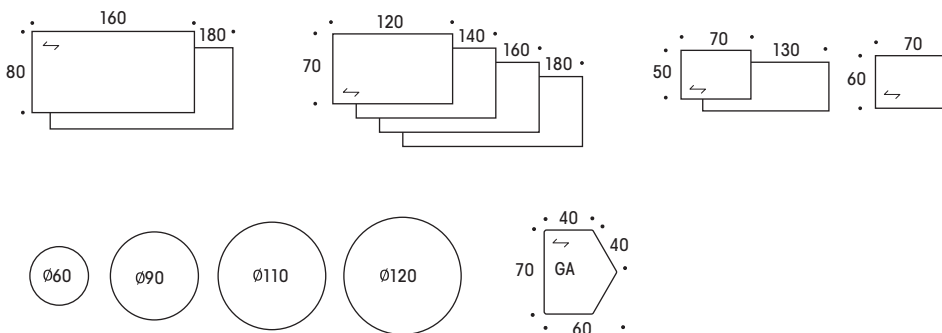

	Tops					Edges			
	Birch	Beech	Oak	Lam 230	Lam 215	ABS 2 mm	Veneer 2 mm	LAM IC MDF	Veneered MDF
A4	•	•	•	•	•	x	x		
A6	•	•	•	•	•	x	x		
A8-20	•	•	•	•	•	x	x		
B4	•	•	•	•	•	x	x		
B6-16	•	•	•	•	•	x	x		
C1	•	•	•	•	•	x	x		
C2	•	•	•	•	•	x	x		
C4	•	•	•	•	•	x	x		
C6	•	•	•	•	•	x	x		
C8	•	•	•	•	•	x	x		
C10	•	•	•	•	•	x	x		
C12-18	•	•	•	•	•	x	x		
D12	•	•	•	•	•	x	x		
Z10	•	•	•	•	•	x	x		
Z12	•	•	•	•	•	x	x		
E12	•	•	•	•	•	x	x		
WE16	•	•	•	•	•	x	x		
WE18	•	•	•	•	•	x	x		
WE20	•	•	•	•	•	x	x		
WD16	•	•	•	•	•	x	x		
WD18	•	•	•	•	•	x	x		
WD20	•	•	•	•	•	x	x		
EL16	•	•	•	•	•	x	x		x
EL18	•	•	•	•	•	x	x		x
EL20	•	•	•	•	•	x	x		x
J12	•	•	•	•	•	x	x		
K8	•	•	•	•	•	x	x		
K16	•	•	•	•	•	x	x		
K17	•	•	•	•	•	x	x		
K18	•	•	•	•	•	x	x		
N1	•	•	•	•	•	x	x		
N2	•	•	•	•	•	x	x		
N3	•	•	•	•	•	x	x		
N4	•	•	•	•	•	x	x		
O6	•	•	•	•	•	x	x		
O9	•	•	•	•	•	x	x		
O11	•	•	•	•	•	x	x		
P5	•	•	•	•	•	x	x	x	x
P6	•	•	•	•	•	x	x	x	x
P7	•	•	•	•	•	x	x	x	x
P8	•	•	•	•	•	x	x	x	x
P11	•	•	•	•	•	x	x	x	x
P12	•	•	•	•	•	x	x	x	x
P16	•	•	•	•	•	x	x	x	x
P17	•	•	•	•	•	x	x	x	x
P18	•	•	•	•	•	x	x	x	x
P19	•	•	•	•	•	x	x	x	x
P20	•	•	•	•	•	x	x	x	x
P21	•	•	•	•	•	x	x	x	x
Q8	•	•	•	•	•	x	x		
Q18	•	•	•	•	•	x	x		
U16	•	•	•	•	•	x	x		
U18	•	•	•	•	•	x	x		
U20	•	•	•	•	•	x	x		
V6	•	•	•	•	•	x	x		
V8	•	•	•	•	•	x	x		
V10	•	•	•	•	•	x	x		
V12	•	•	•	•	•	x	x		

## Products

3016 office chair 130  
7003 coffee table 169  
7303 table 163

### A

Aino Pro 148  
Air 185  
Acoustic elements 195  
Alias 149  
Amphi 88, 139  
Ant 167  
Ark 102, 177  
Aura 149

### B

Big Hug 147

### C

Casa 152  
Cloud 128  
Concorde 147

### D

Desk Bike 127  
Dio 162  
Diva 153  
Diva coffee table 169  
Duo 146  
Duo Lounge 146  
Dyyini 96, 145

### F

Flex 148  
Framery O 185  
Framery Q 185  
Free 151  
Fuuga 179

### G

Geneve Plus Pro 154  
Giant Donut 155

### H

Haiku 163  
Haiku coffee table 169

### I

IKI 148  
ILOA 126  
Inkoo Pro 143  
Inkoo Pro High 98, 143  
Isku Classic T EL 164  
Isku Easy T EL 118, 164  
Isku Style T EL 164

### K

Kaari 94, 140  
Kaari divider 140, 182  
KAB control room chairs 131  
Kantti 167  
Writing boards 194  
Kivikko 82, 138  
Kivikko table 168  
Klik 160

### L

Organiser 191  
Lightness 134  
Lightness chair trolley 134  
Link 184  
Link Line 184  
Logo 136

### M

Mac 124  
Carpets 195  
Matrix I 161  
Matrix T EL Pro 166  
Matrix T manual 164  
Matrix Y 161  
Matti 135  
Matti chair trolley 135  
Metro 146  
Mix 116, 158  
Mode 182  
Mode Akusto 104, 182  
Moni 162  
Move 112, 161  
Mukula 86, 139  
Muvman 127

### N

Coat racks 194  
Noppa 138

### O

Oksa 167  
Ongo 127  
Option 167  
Organo 147  
Osio 162, 166  
Osio coffee table 168

### P

Service desk 191  
Pisa desk 100, 159  
Pisa chair 100, 124  
Poiju 108, 169  
Prima table 160  
Prima chair 92, 124  
PRO 6 125

### R

Roller 106, 194  
Roope 137  
Rosario 147  
Rudolf 132

### S

Salli 128  
Scan 162  
Scan coffee table 169  
Standing mat 191  
Signum 136  
Sigur 145  
Sigur coffee table 168  
Silk plants 197  
Solu 110, 159  
Step+ 130  
Still 129  
Still Meeting 129  
Stone 165  
Summa 114, 158  
Swing coffee table 169  
Syke 142

### T

Taiko 137  
Tendo 172  
Tendo AV 173  
Tendo Mobili 173  
Tendo Oppi 173  
Tere 144  
The Box Lounger 155  
Time 150  
Chair 135  
Tutor 125  
Tutto 90, 134  
Desk accessories 188

### U

UPis1 127

### V

Vakio 176  
Lighting 192

### W

Woodland 185

### X

XO coffee table 168



**Isku Interior showrooms in Finland****Espoo**

Kuifinmäentie 26  
02240 Espoo  
interior.hki@isku.com  
+358 29 086 4201

**Joensuu**

Pilkontie 3  
80130 Joensuu  
interior.joensuu@isku.com  
+358 29 086 4751

**Jyväskylä**

Tourulantie 13  
40100 Jyväskylä  
interior.jkl@isku.com  
+358 29 086 4901

**Kajaani**

Veturitie 1  
87100 Kajaani  
markku.torronen@isku.com  
+358 29 086 4940

**Kokkola**

Pitkäsillankatu 17  
67100 Kokkola  
interior.kokkola@isku.com  
+358 29 086 3901

**Kouvola**

Tommolankatu 7  
45130 Kouvola  
mikko.uusitalo@isku.com  
+358 29 086 4643

**Kotka**

Jumalniementie 4  
48600 Kotka  
interior.kotka@isku.com  
+358 29 086 4648

**Kuopio**

Kartanonkatu 4 A  
70700 Kuopio  
interior.kuopio@isku.com  
+358 29 086 4701

**Lahti**

Mukkulankatu 19  
15210 Lahti  
interior.lahti@isku.com  
+358 29 086 3000

**Lappeenranta**

Myllymäenkatu 34  
53550 Lappeenranta  
interior.lpr@isku.com  
+358 29 086 4601

**Mikkeli**

Graanintie 4  
50190 Mikkeli  
interior.mikkeli@isku.com  
+358 29 086 4371

**Oulu**

Taka-Lyötyn aukio 4  
90140 Oulu  
interior oulu@isku.com  
+358 29 086 4801

**Pori**

Itsenäisyydenkatu 1-5  
28100 Pori  
interior.pori@isku.com  
+358 29 086 4661

**Rovaniemi**

Vierustie 5  
96320 Rovaniemi  
interior.rovaniemi@isku.com  
+358 29 086 4961

**Seinäjoki**

Rengastie 4  
60120 Seinäjoki  
interior.seinajoki@isku.com  
+358 29 086 3931

**Tampere**

Sammonkatu 47  
33540 Tampere  
interior.tampere@isku.com  
+358 29 086 4501

**Tornio**

Pakkahuoneenkatu 1  
95400 Tornio  
petri.toivanen@isku.com  
+358 29 086 4990

**Turku**

Satakunnantie 162  
20320 Turku  
interior.turku@isku.com  
+358 29 086 4401

**Vaasa**

Kivihaantie 4  
65300 Vaasa  
interior.vaasa@isku.com  
+358 29 086 4871

**Vantaa**

Martinkyläntie 47  
01720 Vantaa  
interior.hki@isku.com  
+358 29 086 4201

**Isku Interior offices outside Finland**

Isku Interior Oy Exports  
Mukkulankatu 19  
P.O. Box 240  
FI-15101 LAHTI  
Finland

**Sweden**

Per-Åke Karlsson  
per-ake.karlsson@isku.com

**Norway**

Isku Interiør AS/  
Norengros  
Drammensveien 130 inng. C 6  
0277 OSLO

**Denmark**

Standard Systemer ApS  
Kobbelvænget 74  
2700 COPENHAGEN

**Latvia**

Isku Baltics OÜ  
197 Brivibas gatve  
LV-1012 RIGA

**Lithuania**

Isku Baltics OÜ  
P. Lukšio g. 21  
VILNIUS

**Viro**

Isku Baltics OÜ  
Pärnu mnt. 139f  
EE11317 TALLINNA  
Tallinna linn

**Poland**

Isku Interior Sp. z o.o.  
Oddzial w Polsce  
Prosta Tower, 5th Floor,  
Prosta 32  
00-838 WARSAW

**Russia**

Isku Interier SP  
B.Sergievsky per. 10  
107045 MOSCOW

**Isku Interier SP**

B.Sampsonievsky pr. 4-6, lit.A  
194044 ST. PETERSBURG

**Middle East**

Isku Middle East DMCC  
AG-25-E, Silver Tower, Cluster I  
Jumeirah Lake Towers  
P.O. Box 114494 DUBAI  
U.A.E



## GENERAL TERMS AND DELIVERY CONDITIONS OF ISKU INTERIOR OY, VALID FROM 1 JANUARY 2018

The General Terms and Delivery Conditions of Isku Interior Oy are valid from 1 January 2017 indefinitely and replace any previous general terms and conditions.

These Terms and Delivery Conditions apply to transactions between Isku Interior Oy and the customer, unless otherwise agreed. The Terms and Delivery Conditions apply to the delivery of the goods defined in an order confirmation, unless otherwise agreed in writing.

These terms are considered as approved by the buyer, unless a claim has been submitted within 7 days of the date of the order confirmation.

**Prices** are the prices stated in the currently valid price lists of Isku Interior Oy, unless otherwise mentioned in an offer. The prices include packaging when goods are delivered. Value-added tax according to the currently valid VAT rate and any other similar statutory payments are added to the price.

**An offer is valid** for the product package, unless otherwise agreed. The prices of any additional services defined in the offer will be charged separately. Plans, designs, drawings, images, calculations and other documents related to an offer remain the property of Isku Interior Oy. The customer has no right to use them for its own purposes or to the detriment of Isku Interior Oy or disclose any of the information contained therein to third parties.

**Delivery term:** According to FIN 01 terms delivered to customer's office (between 08.00 and 16.00). A delivery fee according to our price list (min. EUR 69) is charged for delivery.

For **transportation service**, a fee according to our transportation service price list is charged (see Delivery term).

The **goods shall be sent** on the buyer's responsibility and insured on behalf of the buyer, if a transportation has been separately agreed. The insurance fee is 0.25% of the billed price (excl. VAT). No insurance shall be taken out for the State or for Government offices, unless otherwise separately agreed.

The **delivery time** begins when all the information necessary for completing the order has been submitted to Isku Interior Oy and on the date when the order is confirmed by Isku Interior Oy, unless otherwise jointly agreed. Either party shall notify the other party in writing, if there is a risk of delay in the delivery or in accepting the delivery. We reserve the right to change prices and delivery times due to changes and additions to the products by the buyer.

The **delivery week** refers to the week during which the goods will be ready to be delivered to the customer in our delivery office. It is also possible to separately agree that the delivery week is the week when any contractual installation work or service begins or has been completed.

For **postponement of delivery time** by the customer or due to any other reason not attributable to the seller which is more than one week from the agreed delivery week, 0.5% of the value of the delivery shall be charged from the customer for each week. A postponement of delivery must be agreed upon at least 10 business days before the expected delivery date.

The **payment term** is 7 days net of the invoice date, unless otherwise agreed. The seller has the right to send an invoice for partial deliveries.

If there is no separate agreement on invoicing of total price, the seller may send an invoice for the delivered parts when at least 90% of the value of the transaction has been delivered. A penal interest referred to in the Interest Act (633/1982) and any collection fees shall be charged for any overtime.

**Invoices** shall be sent electronically. For paper invoices, a fee of EUR 10 per order shall be charged.

Any missing items or claims shall be notified in writing within 7 days of receiving the goods or services. Even if there are missing items or other claims, at least 90% of the invoice shall always be paid according to the agreed payment term, unless the claim concerns more than 10% of the value of the delivery. A delivery that corresponds to an order cannot be returned.

The **right of title** to the goods is not passed to the buyer before the purchase price has been paid in full. The risk of loss is passed to the customer once the goods have been delivered according to delivery terms.

For **installation service**, we charge a separate fee according to our installation service price list, unless otherwise mentioned in the offer. The installation service costs 3% of the grand total of the order or at least EUR 75.

Isku Interior Oy has the right to charge for any extra work, including but not limited to the following: clearing a room or space, second delivery round, storage and/or installation work not related to the subject of this transaction.

The **warranty period** for standard items in the collection that are manufactured by Isku is five (5) years. For other than standard items, the warranty period is two (2) years. The warranty is valid for normal conditions of use. The warranty period is two years for control room desks

and chairs and other products, including wearable parts such as gas cylinders and caster wheels, that are in uninterrupted use (24/7). No warranty shall be granted for upholstery materials or surface treatments that do not belong to the Isku collection. Isku has the right to choose to either grant a reduction of the price of the product, remedy the material or manufacturing faults in the product or replace the faulty product. If a good is repaired or replaced with a new one within the warranty period, the warranty period shall not be extended. The warranty does not cover normal wear and tear or damage caused by mishandling of the product. The warranty is valid only if the user and care instructions as well as installation instructions of the product and the materials have been followed. The warranty begins on delivery and cannot be passed on from the original customer to a new owner. The customer must present a written claim concerning the guarantee within the guarantee period and within eight (8) business days of becoming aware of the fault. The product warranties of other manufacturers are determined according to the guarantees granted by them.

In case of **personal injury or damage to property**, Isku Interior Oy is liable for any damage caused by the good(s) it has delivered pursuant to the provisions of the Product Liability Act. Isku Interior is not liable for any damage caused to immovable property.

In case of **force majeure**, which makes it impossible or materially difficult to meet these Terms and Conditions of Delivery, the parties have an equal right to be released of their delivery or reception obligation at the agreed time, either in part or in full.

**Indirect damage.** Isku Interior Oy is not obliged to compensate the customer for any indirect damage due to delay or incorrect delivery.

**Disputes** possibly caused by the agreement that cannot be settled amicably within a reasonable period of time shall be submitted for resolution to the Lahti District Court or, if Isku Interior Oy so demands in writing, to a one-man court of arbitration appointed by the The Arbitration Institute of the Finland Chamber of Commerce according to its arbitration rules.

Isku Interior Oy reserves the right to change the Terms and Conditions of Delivery.

Valid indefinitely from 1 January 2018.

Isku Interior Oy  
Mukkulankatu 19, FI-15210 Lahti, Finland  
P.O. Box 240, FI-15101 Lahti, Finland  
Registered office: Lahti, Business ID:  
1831497-2

Isku Interior Oy  
Mukkulankatu 19, P.O. Box 240  
FI-15101 Lahti, Finland  
+358 29 086 3000  
www.isku.com

© Isku Interior Oy  
All rights reserved.

Art direction: Suvi Mäkinen &  
Mona Auervuolle

Photography: Tuomas Heikkilä / Isku Interior  
and suppliers

Printed by KariTeam, Jyväskylä, 2018  
The paper of this catalogue comes from  
sustainably managed forests.



Kestävän  
metsätalouden  
edistämiseksi  
[www.pefc.fi](http://www.pefc.fi)



Since 1928

ISKU  
90

[www.isku.com](http://www.isku.com)