



# Junction boxes

X series



# X-TREME

The new X series



## Extremely robust

With the X series, OBO Bettermann can offer a range of junction boxes and empty housings that can withstand even the toughest mechanical impacts. The use of special plastics based on high-quality polycarbonate allows the X series to meet the requirements for the highest impact resistance achieving the protection rating of IK09. The high quality of the X series is guaranteed by the tests according to DIN EN 60670 Part 1 and 22. However, the X series not only stands out because of its robustness but also because of its

functional and well thought-out design. The boxes can be fastened using internal, external or corner fastening. This means they can be flexibly adapted to suit the requirements of a number of installation scenarios. Practical tests have shown that particularly the high wiring space is valued by users.

The X series can fulfil any requirements made of contemporary, practically orientated junction boxes.

## Wide range of sizes

**X01** 95 x 95 x 60



**X10** 190 x 150 x 125

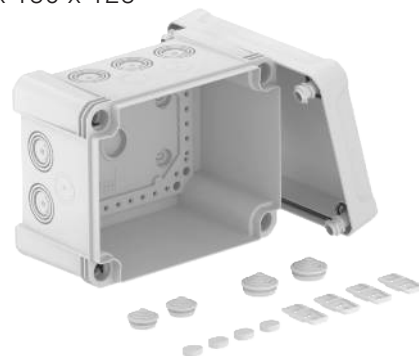

**X02** 95 x 95 x 72



**X16** 240 x 191 x 125



**X04** 114 x 114 x 78



**X25** 286 x 202 x 126

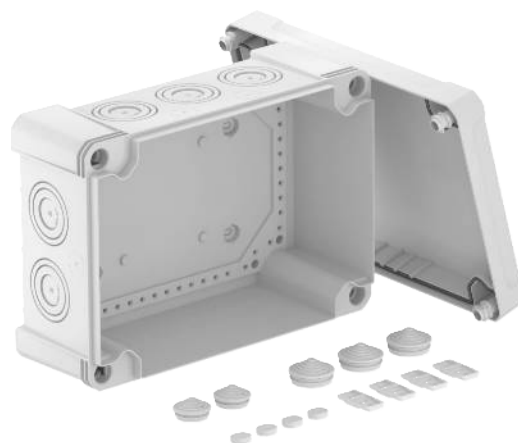

**X06** 151 x 167 x 87



## The X series

### Impact-resistant

The use of special plastics based on high-quality polycarbonate allows the X series to meet the requirements for the highest impact resistance achieving the protection rating of IK09. All the boxes of the X series are tested according to DIN EN 60670 Part 1 and 22.



### Adaptable

The junction boxes have been tested in practical applications and have certainly not been found wanting: Thus the X series offers high wiring space and simple and particularly flexible fastening. The junction boxes can be mounted using internal, external or corner fastenings, as required.

## Equipment

The X series is available in different equipment versions. For example, completely pre-installed versions with main terminal blocks, cable glands, screwless terminals and hat rails are available.



## Accessories

Screw covers, plug-in seals and external fastening elements are contained in the scope of delivery of the X series junction boxes. In addition, the X series offers a comprehensive range of accessories.

When used in unprotected external areas, we recommend protecting the junction box against direct weathering influences (e.g. from snow, wind, rain or sun).

## Proud to be colourful

In any colour variation, the X series is a real eye-catcher. With light grey, transparent, black and red elements in different constellations, it is easy to tell different circuits apart.





01 VBS Broschüre X-Serie 2018 / en / 07/06/2018 (LL Export\_04055) / 07/06/2018

## Variety

The junction box families of OBO Bettermann







### A series: Forever young

The timeless classic: Halogen-free thermoplastic is just as much of a hallmark of the A series as a tight-fitting clamshell and pre-marked cable entries. A protection rating of IP55 and practical external fastenings round off the profile of this classic item.



### X series: Extremely robust

The X series covers all the requirements for modern connection sockets: With a rating of IK09, the X series junction boxes show their particularly high impact resistance. At the same time, the junction boxes stand out because of their functional, well thought-out design. The simple and flexible mounting, either with internal, external or corner fastening, stands out in the practical test, as does the particularly high wiring space.



### T series: Universal

With high-quality materials, sensible wall thicknesses and a stable construction, the T series is intelligent to the core. All the junction boxes of the T series are marked by their UV-resistant, impact-resistant and halogen-free material and are ideally suited for use both indoors and protected outdoor areas.

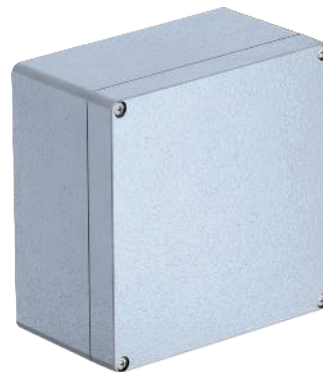





### MX series: Real hard cases







The aluminium empty housings of the MX series were designed for use under the toughest conditions and provide optimum protection of an installation. Their metal housing can resist both extremely high and low temperatures as well as major differences in temperature. Even high impact loads in an industrial surrounding, vandalism or rock falls are not able to harm the housing.

## Type overview





### Junction box colour variants

				
	Light grey / light grey	Light grey / transparent	Graphite black / graphite black	Graphite black / red
<b>X 01</b>	X01 LGR	X01 LGR-TR	X01 SW	X01 SW-RO
<b>X 02</b>	X02 LGR	X02 LGR-TR	X02 SW	X02 SW-RO
<b>X 04</b>	X04 LGR	X04 LGR-TR	X04 SW	X04 SW-RO
<b>X 06</b>	X06 LGR	X06 LGR-TR	X06 SW	X06 SW-RO
<b>X 10</b>	X10 LGR	X10 LGR-TR	X10 SW	X10 SW-RO
<b>X 16</b>	X16 LGR	X16 LGR-TR	X16 SW	X16 SW-RO
<b>X 25</b>	X25 LGR	X25 LGR-TR	X25 SW	X25 SW-RO

### Junction box sets

						
	With terminal strip	With terminal strip, cable glands and locknuts	With cable glands and locknuts	With universal screwless terminals, cable glands and locknuts	With transparent cover and hat profile rail	With main terminal block
<b>X 01</b>	X01 T LGR	X01 T G M20 LGR	X01 G M20 LGR	X01 UT G LGR		
<b>X 02</b>	X02 T LGR	X02 T G M20 LGR	X02 G M20 LGR	X02 UT G LGR		
<b>X 04</b>	X04 T LGR	X04 T G M20 LGR	X04 G M20 LGR	X04 UT G LGR		
<b>X 06</b>	X06 T LGR	X06 T G M20 LGR			X06 R LGR-TR	X06 H25 GNP4
<b>X 10</b>	X10 T LGR				X10 R LGR-TR	X10 H25 GNP5
<b>X 16</b>	X16 T LGR				X16 R LGR-TR	X16 H25 GNP5 X16 H35 GNP5
<b>X 25</b>	X25 T LGR				X25 R LGR-TR	X25 H25 GNP5 X25 H35 GNP5

### Empty housing colour variants and sets

					
	Light grey / light grey	Light grey / transparent	Graphite black / graphite black	Light grey / light grey with hat profile rail	Light grey / transparent with hat profile rail
<b>X 01</b>	X01C LGR	X01C LGR-TR	X01C SW		
<b>X 02</b>	X02C LGR	X02C LGR-TR	X02C SW		
<b>X 04</b>	X04C LGR	X04C LGR-TR	X04C SW		
<b>X 06</b>	X06C LGR	X06C LGR-TR	X06C SW	X06C R LGR	X06C R LGR-TR
<b>X 10</b>	X10C LGR	X10C LGR-TR	X10C SW	X10C R LGR	X10C R LGR-TR
<b>X 16</b>	X16C LGR	X16C LGR-TR	X16C SW	X16C R LGR	X16C R LGR-TR
<b>X 25</b>	X25C LGR	X25C LGR-TR	X25C SW	X25C R LGR	X25C R LGR-TR



X 02  
IP67  
**OBO** 700 V  
MULTI-MEDIALE  
EFT-BUSCH-1 874 60673-02

# Junction box X series with knock-out entries and plug-in seals



- Junction boxes with impact resistance IK09 and protection class IP67 can withstand even strong mechanical impacts
- Made of high-quality, halogen-free and UV-resistant polycarbonate
- Tested to DIN EN 60670 Part 1 and 22
- The scope of delivery contains screw cover caps, external fastening elements and plug-in seals

## Junction box X 01

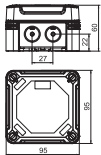
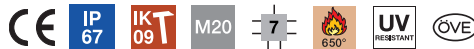

**Type**  
 Colour  
 Entries  
 Dimension LxWxH mm  
 Clear internal dimensions mm  
 Pack. pcs  
 Weight kg/100 pcs.  
**Item No.**

Type	X01 LGR	X01 LGR-TR	X01 SW	X01 SW-RO
Colour	Light grey	Grey / transparent	Graphite black	Black / red
Entries	7 x Ø20	7 x Ø20	7 x Ø20	7 x Ø20
Dimension LxWxH mm	95x95x60	95x95x60	95x95x60	95x95x60
Clear internal dimensions mm	85 x 85 x 45	85 x 85 x 45	85 x 85 x 45	85 x 85 x 45
Pack. pcs	1	1	1	1
Weight kg/100 pcs.	16.000	16.000	16.000	16.000
<b>Item No.</b>	<b>2005000</b>	<b>2005050</b>	<b>2005110</b>	<b>2005140</b>

PC Polycarbonate

## Junction box X 02

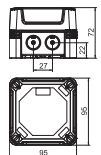
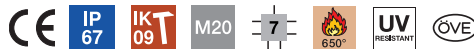

**Type**  
 Colour  
 Entries  
 Dimension LxWxH mm  
 Clear internal dimensions mm  
 Pack. pcs  
 Weight kg/100 pcs.  
**Item No.**

Type	X02 LGR	X02 LGR-TR	X02 SW	X02 SW-RO
Colour	Light grey	Grey / transparent	Graphite black	Black / red
Entries	7 x Ø20	7 x Ø20	7 x Ø20	7 x Ø20
Dimension LxWxH mm	95x95x72	95x95x72	95x95x72	95x95x72
Clear internal dimensions mm	85 x 85 x 57	85 x 85 x 57	85 x 85 x 57	85 x 85 x 57
Pack. pcs	1	1	1	1
Weight kg/100 pcs.	17.800	17.800	17.800	17.800
<b>Item No.</b>	<b>2005004</b>	<b>2005054</b>	<b>2005114</b>	<b>2005144</b>

PC Polycarbonate

## Junction box X 04

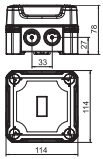

Type	X04 LGR	X04 LGR-TR	X04 SW	X04 SW-RO
Colour	Light grey	Grey / transparent	Graphite black	Black / red
Entries	7 x Ø20/25	7 x Ø20/25	7 x Ø20/25	7 x Ø20/25
Dimension LxWxH mm	114x114x78	114x114x78	114x114x78	114x114x78
Clear internal dimensions mm	102 x 102 x 60	102 x 102 x 60	102 x 102 x 60	102 x 102 x 60
Pack. pcs	1	1	1	1
Weight kg/100 pcs.	26.600	26.600	26.600	26.600
<b>Item No.</b>	<b>2005008</b>	<b>2005058</b>	<b>2005118</b>	<b>2005148</b>

PC Polycarbonate

## Junction box X 06

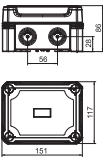

Type	X06 LGR	X06 LGR-TR	X06 SW	X06 SW-RO
Colour	Light grey	Grey / transparent	Graphite black	Black / red
Entries	8 x Ø20/25	8 x Ø20/25	8 x Ø20/25	8 x Ø20/25
Dimension LxWxH mm	151x167x87	151x167x87	151x167x87	151x167x87
Clear internal dimensions mm	137 x 105 x 68	137 x 105 x 68	137 x 105 x 68	137 x 105 x 68
Pack. pcs	1	1	1	1
Weight kg/100 pcs.	33.500	33.600	33.500	33.500
<b>Item No.</b>	<b>2005012</b>	<b>2005062</b>	<b>2005122</b>	<b>2005152</b>

PC Polycarbonate

## Junction box X 10



Type	X10 LGR	X10 LGR-TR	X10 SW	X10 SW-RO
Colour	Light grey	Grey / transparent	Graphite black	Black / red
Entries	10 x Ø20/25/32	10 x Ø20/25/32	10 x Ø20/25/32	10 x Ø20/25/32
Dimension LxWxH mm	191x151x126	191x151x126	191x151x126	191x151x126
Clear internal dimensions mm	177 x 137 x 110	177 x 137 x 110	177 x 137 x 110	177 x 137 x 110
Pack. pcs	1	1	1	1
Weight kg/100 pcs.	59.200	59.200	59.200	59.200
<b>Item No.</b>	<b>2005016</b>	<b>2005066</b>	<b>2005126</b>	<b>2005156</b>

PC Polycarbonate

## Junction box X 16

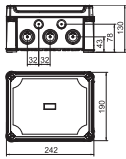

**Type**  
 Colour  
 Entries  
 Dimension LxWxH mm  
 Clear internal dimensions mm  
 Pack. pcs  
 Weight kg/100 pcs.  
**Item No.**

	X16 LGR	X16 LGR-TR	X16 SW	X16 SW-RO
Colour	Light grey	Grey / transparent	Graphite black	Black / red
Entries	10 x Ø25/32/40	10 x Ø25/32/40	10 x Ø25/32/40	10 x Ø25/32/40
Dimension LxWxH mm	241x191x126	241x191x126	241x191x126	241x191x126
Clear internal dimensions mm	227 x 177 x 110	227 x 177 x 110	227 x 177 x 110	227 x 177 x 110
Pack. pcs	1	1	1	1
Weight kg/100 pcs.	79.300	79.300	79.300	79.300
<b>Item No.</b>	<b>2005020</b>	<b>2005070</b>	<b>2005130</b>	<b>2005160</b>

PC Polycarbonate

## Junction box X 25

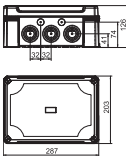

**Type**  
 Colour  
 Entries  
 Dimension LxWxH mm  
 Clear internal dimensions mm  
 Pack. pcs  
 Weight kg/100 pcs.  
**Item No.**

	X25 LGR	X25 LGR-TR	X25 SW	X25 SW-RO
Colour	Light grey	Grey / transparent	Graphite black	Black / red
Entries	10 x Ø25/32/40	10 x Ø25/32/40	10 x Ø25/32/40	10 x Ø25/32/40
Dimension LxWxH mm	286x202x126	286x202x126	286x202x126	286x202x126
Clear internal dimensions mm	271 x 187 x 110	271 x 187 x 110	271 x 187 x 110	271 x 187 x 110
Pack. pcs	1	1	1	1
Weight kg/100 pcs.	96.500	96.500	96.500	96.500
<b>Item No.</b>	<b>2005024</b>	<b>2005074</b>	<b>2005134</b>	<b>2005164</b>

PC Polycarbonate

# Junction box X series with knock-out entries and cable glands



- Junction boxes with impact resistance IK09 and protection class IP67 can withstand even strong mechanical impacts
- Made of high-quality, halogen-free, UV-resistant polycarbonate
- Tested to DIN EN 60670 Part 1 and 22
- Besides screw cover caps, external fastening elements and plug-in seals, the scope of delivery also contains three V-TEC M20 cable glands with matching locknuts

## Junction box X 01 with cable glands

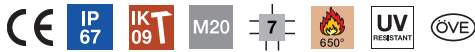

Type	Colour	Entries	Pack. pcs	Weight kg/100 pcs.	Item No.
<b>X01 G M20 LGR</b>	Light grey	7 x Ø20	1	19.000	2005030

PC Polycarbonate

Type	Dimension LxWxH mm	Clear internal dimensions mm
<b>X01 G M20 LGR</b>	95x95x60	85 x 85 x 45

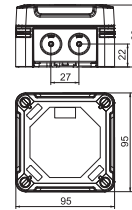

Dimensions



## Junction box X 02 with cable glands



Type	Colour	Entries	Pack. pcs	Weight kg/100 pcs.	Item No.
<b>X02 G M20 LGR</b>	Light grey	7 x Ø20	1	21.500	2005032

PC Polycarbonate

Type	Dimension LxWxH mm	Clear internal dimensions mm
<b>X02 G M20 LGR</b>	95x95x72	85 x 85 x 57

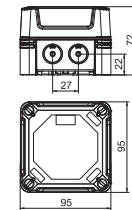

Dimensions



## Junction box X 04 with cable glands



Type	Colour	Entries	Pack. pcs	Weight kg/100 pcs.	Item No.
<b>X04 G M20 LGR</b>	Light grey	7 x Ø20/25	1	31.400	2005034

PC Polycarbonate

Type	Dimension LxWxH mm	Clear internal dimensions mm
<b>X04 G M20 LGR</b>	114x114x78	102 x 102 x 60

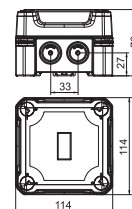

Dimensions



# Junction box X series with knock-out entries and terminal strip



- Junction boxes with impact resistance IK09 and protection class IP67 can withstand even strong mechanical impacts
- Made of high-quality, halogen-free, UV-resistant polycarbonate
- Tested to DIN EN 60670 Part 1 and 22
- Besides screw cover caps, external fastening elements and plug-in seals, the scope of delivery also contains a terminal strip matched to the cross-section

## Junction box X 01 with terminal strip

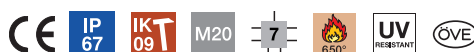
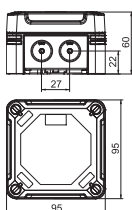

Colour Entries

Type	Colour	Entries	Pack. pcs	Weight kg/100 pcs.	Item No.
<b>X01 T LGR</b>	Light grey	7 x Ø20	1	17.500	2005190

PC Polycarbonate

The scope of delivery contains a 5-pole terminal strip.

### Dimensions

Type	Dimension LxWxH mm	Clear internal dimensions mm
<b>X01 T LGR</b>	95x95x60	85 x 85 x 45

## Junction box X 02 with terminal strip

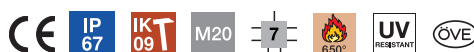
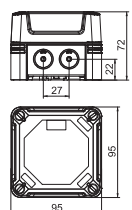

Colour Entries

Type	Colour	Entries	Pack. pcs	Weight kg/100 pcs.	Item No.
<b>X02 T LGR</b>	Light grey	7 x Ø20	1	19.300	2005194

PC Polycarbonate

The scope of delivery contains a 5-pole terminal strip.

### Dimensions

Type	Dimension LxWxH mm	Clear internal dimensions mm
<b>X02 T LGR</b>	95x95x72	85 x 85 x 57

## Junction box X 04 with terminal strip

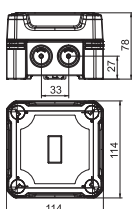

Colour Entries

Type	Colour	Entries	Pack. pcs	Weight kg/100 pcs.	Item No.
<b>X04 T LGR</b>	Light grey	7 x Ø20/25	1	31.600	2005198

PC Polycarbonate

The scope of delivery contains a 5-pole terminal strip.

### Dimensions

Type	Dimension LxWxH mm	Clear internal dimensions mm
<b>X04 T LGR</b>	114x114x78	102 x 102 x 60



## Junction box X 06 with terminal strip



Colour Entries

Type	Colour	Entries	Pack. pcs	Weight kg/100 pcs.	Item No.
<b>X06 T LGR</b>	Light grey	8 x Ø20/25	1	38.000	2005202

PC Polycarbonate

The scope of delivery contains a 5-pole terminal strip.

Type	Dimension LxWxH mm	Clear internal dimensions mm
<b>X06 T LGR</b>	151x167x87	137 x 105 x 68

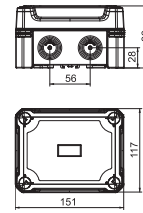

Dimensions

## Junction box X 10 with terminal strip



Colour Entries

Type	Colour	Entries	Pack. pcs	Weight kg/100 pcs.	Item No.
<b>X10 T LGR</b>	Light grey	10 x Ø20/25/32	1	72.000	2005206

PC Polycarbonate

The scope of delivery contains 5 terminal strips, each with 4 terminals.

Type	Dimension LxWxH mm	Clear internal dimensions mm
<b>X10 T LGR</b>	191x151x126	177 x 137 x 110

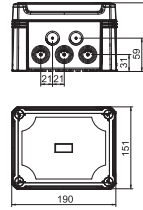

Dimensions

## Junction box X 16 with terminal strip



Colour Entries

Type	Colour	Entries	Pack. pcs	Weight kg/100 pcs.	Item No.
<b>X16 T LGR</b>	Light grey	10 x Ø25/32/40	1	97.500	2005210

PC Polycarbonate

The scope of delivery contains 5 terminal strips, each with 4 terminals.

Type	Dimension LxWxH mm	Clear internal dimensions mm
<b>X16 T LGR</b>	241x191x126	227 x 177 x 110

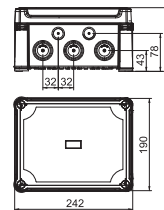

Dimensions

## Junction box X 25 with terminal strip



Colour Entries

Type	Colour	Entries	Pack. pcs	Weight kg/100 pcs.	Item No.
<b>X25 T LGR</b>	Light grey	10 x Ø25/32/40	1	130.000	2005214

PC Polycarbonate

The scope of delivery contains 5 terminal strips, each with 4 terminals.

Type	Dimension LxWxH mm	Clear internal dimensions mm
<b>X25 T LGR</b>	286x202x126	271 x 187 x 110

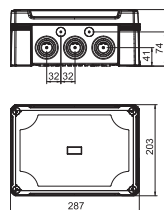

Dimensions

# Junction box X series with knock-out entries, cable glands and terminal strip



- Junction boxes with impact resistance IK09 and protection class IP67 can withstand even strong mechanical impacts
- Made of high-quality, halogen-free, UV-resistant polycarbonate
- Tested to DIN EN 60670 Part 1 and 22
- Besides screw cover caps, external fastening elements and plug-in seals, the scope of delivery also contains a terminal strip matched to the cross-section and three V-TEC M20/M25 cable glands with matching locknuts

## Junction box X 01 with cable glands and terminal strip

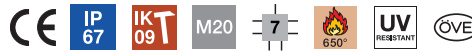
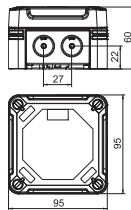

Type	Colour	Entries	Pack. pcs	Weight kg/100 pcs.	Item No.
<b>X01 T G M20 LGR</b>	Light grey	7 x Ø20	1	20.500	<b>2005220</b>

PC Polycarbonate

A terminal strip, three V-TEC M20 cable glands and three matching locknuts are included.

### Dimensions

Type	Dimension LxWxH mm	Clear internal dimensions mm
<b>X01 T G M20 LGR</b>	95x95x60	85 x 85 x 45

## Junction box X 02 with cable glands and terminal strip

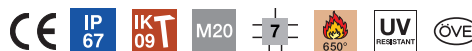
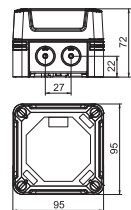

Type	Colour	Entries	Pack. pcs	Weight kg/100 pcs.	Item No.
<b>X02 T G M20 LGR</b>	Light grey	7 x Ø20	1	23.000	<b>2005222</b>

PC Polycarbonate

A terminal strip, three V-TEC M20 cable glands and three matching locknuts are included.

### Dimensions

Type	Dimension LxWxH mm	Clear internal dimensions mm
<b>X02 T G M20 LGR</b>	95x95x72	85 x 85 x 57

## Junction box X 04 with cable glands and terminal strip

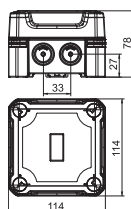

Type	Colour	Entries	Pack. pcs	Weight kg/100 pcs.	Item No.
<b>X04 T G M25 LGR</b>	Light grey	7 x Ø20/25	1	36.700	<b>2005224</b>

PC Polycarbonate

A terminal strip, three V-TEC M25 cable glands and three matching locknuts are included.

### Dimensions

Type	Dimension LxWxH mm	Clear internal dimensions mm
<b>X04 T G M25 LGR</b>	114x114x78	102 x 102 x 60

## Junction box X 06 with cable glands and terminal strip



Colour Entries

Pack. Weight  
pcs kg/100 pcs. Item No.

Type	Colour	Entries	Pack. pcs	Weight kg/100 pcs.	Item No.
<b>X06 T G M25 LGR</b>	Light grey	8 x Ø20/25	1	28.000	<b>2005226</b>

**PC** Polycarbonate

A terminal strip, three V-TEC M25 cable glands and three matching locknuts are included.

Type	Dimension LxWxH mm	Clear internal dimensions mm
<b>X06 T G M25 LGR</b>	151x167x87	137 x 105 x 68

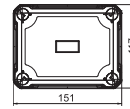
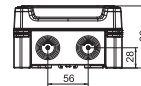

Dimensions

# Junction box X series with knock-out entries, cable glands and screwless terminals



- Junction boxes with impact resistance IK09 and protection class IP67 can withstand even strong mechanical impacts
- Made of high-quality, halogen-free, UV-resistant polycarbonate
- Tested to DIN EN 60670 Part 1 and 22
- The scope of delivery contains screw cover caps, external fastening elements and plug-in seals. In addition, these junction boxes include three V-TEC cable glands and three screwless terminals

## Junction box X 01 with cable glands and screwless terminals

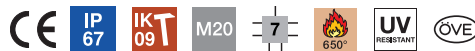
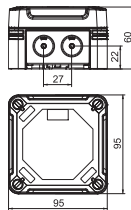

Type	Colour	Entries	Pack. pcs	Weight kg/100 pcs.	Item No.
<b>X01 UT G LGR</b>	Light grey	7 x Ø20	1	20.000	<b>2005240</b>

PC Polycarbonate

Three universal clamps (with 5 clamping points), three V-TEC M20 cable glands and three matching locknuts are included.

### Dimensions

Type	Dimension LxWxH mm	Clear internal dimensions mm
<b>X01 UT G LGR</b>	95x95x60	85 x 85 x 45

## Junction box X 02 with cable glands and screwless terminals

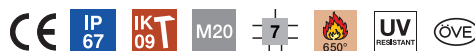
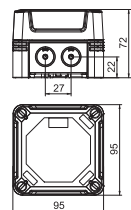

Type	Colour	Entries	Pack. pcs	Weight kg/100 pcs.	Item No.
<b>X02 UT G LGR</b>	Light grey	7 x Ø20	1	23.000	<b>2005244</b>

PC Polycarbonate

Three universal clamps (with 5 clamping points), three V-TEC M20 cable glands and three matching locknuts are included.

### Dimensions

Type	Dimension LxWxH mm	Clear internal dimensions mm
<b>X02 UT G LGR</b>	95x95x72	85 x 85 x 57

## Junction box X 04 with cable glands and screwless terminals



Type	Colour	Entries	Pack. Weight		Item No.
			pcs	kg/100 pcs.	
<b>X04 UT G LGR</b>	Light grey	7 x Ø20/25	1	33.500	<b>2005248</b>

**PC** Polycarbonate

Three universal clamps (with 5 clamping points), three V-TEC M25 cable glands and three matching locknuts are included.

Type	Dimension	Clear internal
	LxWxH mm	dimensions mm
<b>X04 UT G LGR</b>	114x114x78	102 x 102 x 60

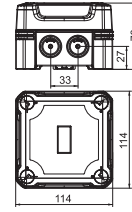

Dimensions

# Junction box X series with knock-out entries and hat profile rail



- Junction boxes with impact resistance IK09 and protection class IP67 can withstand even strong mechanical impacts
- Made of high-quality, halogen-free, UV-resistant polycarbonate
- Tested to DIN EN 60670 Part 1 and 22
- Besides screw cover caps, external fastening elements and plug-in seals, the scope of delivery also contains a hat rail set consisting of a hat rail, type 2069, and matching fastening elements

## Junction box X 06 with hat profile rail

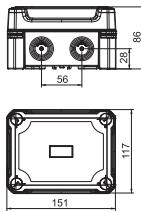

Type	Colour	Entries	Pack. pcs	Weight kg/100 pcs.	Item No.
<b>X06 R LGR-TR</b>	Grey / transparent	8 x Ø20/25	1	37.600	<b>2005092</b>

PC Polycarbonate

With transparent cover and hat profile rail, type 2069, with fastening set.

### Dimensions

Type	Dimension LxWxH mm	Clear internal dimensions mm
<b>X06 R LGR-TR</b>	151x167x87	137 x 105 x 68

## Junction box X 10 with hat profile rail

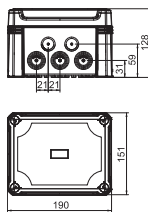

Type	Colour	Entries	Pack. pcs	Weight kg/100 pcs.	Item No.
<b>X10 R LGR-TR</b>	Grey / transparent	10 x Ø20/25/32	1	65.600	<b>2005096</b>

PC Polycarbonate

With transparent cover and hat profile rail, type 2069, with fastening set.

### Dimensions

Type	Dimension LxWxH mm	Clear internal dimensions mm
<b>X10 R LGR-TR</b>	191x151x126	177 x 137 x 110

## Junction box X 16 with hat profile rail

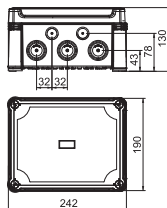

Type	Colour	Entries	Pack. pcs	Weight kg/100 pcs.	Item No.
<b>X16 R LGR-TR</b>	Grey / transparent	10 x Ø25/32/40	1	87.300	<b>2005100</b>

PC Polycarbonate

With transparent cover and hat profile rail, type 2069, with fastening set.

### Dimensions

Type	Dimension LxWxH mm	Clear internal dimensions mm
<b>X16 R LGR-TR</b>	241x191x126	227 x 177 x 110

## Junction box X 25 with hat profile rail



Type	Colour	Entries	Pack. pcs	Weight kg/100 pcs.	Item No.
<b>X25 R LGR-TR</b>	Grey / transparent	10 x Ø25/32/40	1	107.000	<b>2005104</b>

**PC** Polycarbonate

With transparent cover and hat profile rail, type 2069, with fastening set.

Type	Dimension LxWxH mm	Clear internal dimensions mm
<b>X25 R LGR-TR</b>	286x202x126	271 x 187 x 110

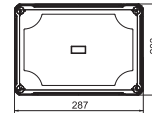
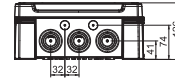

**Dimensions**

# Junction box X series with knock-out entries and main terminal block



- Junction boxes with impact resistance IK09 and protection class IP67 can withstand even strong mechanical impacts
- Made of high-quality, halogen-free, UV-resistant polycarbonate
- Tested to DIN EN 60670 Part 1 and 22
- Besides screw cover caps, external fastening elements and plug-in seals, the scope of delivery also contains a pre-mounted hat rail and main terminal block for the appropriate cross-section

## Junction box X 06 with main terminal block

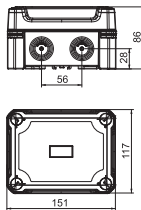

Type	Colour	Entries	Pack. pcs	Weight kg/100 pcs.	Item No.
<b>X06 H25 GP4 LGR</b>	Light grey	8 x Ø20/25	1	56.800	<b>2005304</b>

PC Polycarbonate

A 4-pole main terminal block is included with 16 clamping points. For 25 mm<sup>2</sup> cable cross-section

### Dimensions

Type	Dimension LxWxH mm	Clear internal dimensions mm
<b>X06 H25 GP4 LGR</b>	151x167x87	137 x 105 x 68

## Junction box X 10 with main terminal block

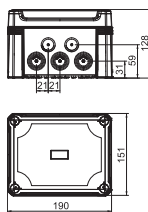

Type	Colour	Entries	Pack. pcs	Weight kg/100 pcs.	Item No.
<b>X10 H25 GNP5 LGR</b>	Light grey	10 x Ø20/25/32	1	104.000	<b>2005308</b>

PC Polycarbonate

A 5-pole main terminal block is included with 20 clamping points. For 25 mm<sup>2</sup> cable cross-section

### Dimensions

Type	Dimension LxWxH mm	Clear internal dimensions mm
<b>X10 H25 GNP5 LGR</b>	191x151x126	177 x 137 x 110



## Junction box X 16 with main terminal block



Type	Colour	Entries	Pack. pcs	Weight kg/100 pcs.	Item No.
<b>X16 H25 GNP5 LGR</b>	Light grey	10 x Ø25/32/40	1	111.000	<b>2005312</b>
<b>X16 H35 GNP5 LGR</b>	Light grey	10 x Ø25/32/40	1	125.000	<b>2005316</b>

PC Polycarbonate

A 5-pole main terminal block is included with 20 clamping points.

X16 H25 GNP5 LGR: for 25 mm<sup>2</sup> conductor cross-section

X16 H35 GNP5 LGR: for 35 mm<sup>2</sup> conductor cross-section

Type	Dimension LxWxH mm	Clear internal dimensions mm
<b>X16 H25 GNP5 LGR</b>	241x191x126	227 x 177 x 110
<b>X16 H35 GNP5 LGR</b>	241x191x126	227 x 177 x 110

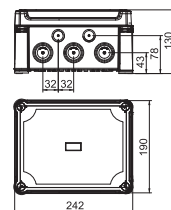

Dimensions

## Junction box X 25 with main terminal block



Type	Colour	Entries	Pack. pcs	Weight kg/100 pcs.	Item No.
<b>X25 H35 GNP5 LGR</b>	Light grey	10 x Ø25/32/40	1	145.000	<b>2005320</b>
<b>X25 H50 GNP5 LGR</b>	Light grey	10 x Ø25/32/40	1	165.000	<b>2005324</b>

PC Polycarbonate

A 5-pole main terminal block is included with 20 clamping points.

X25 H35 GNP5 LGR: for 35 mm<sup>2</sup> conductor cross-section

X25 H50 GNP5 LGR: for 50 mm<sup>2</sup> conductor cross-section

Type	Dimension LxWxH mm	Clear internal dimensions mm
<b>X25 H35 GNP5 LGR</b>	286x202x126	271 x 187 x 110
<b>X25 H50 GNP5 LGR</b>	286x202x126	271 x 187 x 110

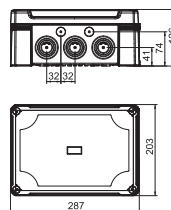

Dimensions

# Empty housing, X series without entries



- In comparison to junction boxes, empty housings do not have any entry openings. They can be drilled individually for the application
- Tested to DIN EN 60670 Part 1 and 22
- The scope of delivery contains screw cover caps and external fastening elements

## Empty housing X 01

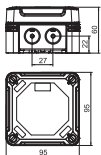

### Type

Colour  
Dimension LxWxH mm  
Clear internal dimensions mm  
Pack. pcs  
Weight kg/100 pcs.  
**Item No.**

Type	X01C LGR	X01C LGR-TR	X01C SW
Colour	Light grey	Grey / transparent	Graphite black
Dimension LxWxH mm	95x95x60	95x95x60	95x95x60
Clear internal dimensions mm	85 x 85 x 45	85 x 85 x 45	85 x 85 x 45
Pack. pcs	1	1	1
Weight kg/100 pcs.	15.600	15.600	15.600
<b>Item No.</b>	<b>2005450</b>	<b>2005520</b>	<b>2005590</b>

PC Polycarbonate

## Empty housing X 02

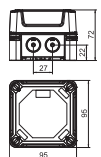

### Type

Colour  
Dimension LxWxH mm  
Clear internal dimensions mm  
Pack. pcs  
Weight kg/100 pcs.  
**Item No.**

Type	X02C LGR	X02C LGR-TR	X02C SW
Colour	Light grey	Grey / transparent	Graphite black
Dimension LxWxH mm	95x95x72	95x95x72	95x95x72
Clear internal dimensions mm	85 x 85 x 57	85 x 85 x 57	85 x 85 x 57
Pack. pcs	1	1	1
Weight kg/100 pcs.	17.500	17.500	17.500
<b>Item No.</b>	<b>2005454</b>	<b>2005524</b>	<b>2005594</b>

PC Polycarbonate

## Empty housing X 04

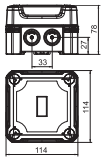

Type	X04C LGR	X04C LGR-TR	X04C SW
Colour	Light grey	Grey / transparent	Graphite black
Dimension LxWxH mm	114x114x78	114x114x78	114x114x78
Clear internal dimensions mm	102 x 102 x 60	102 x 102 x 60	102 x 102 x 60
Pack. pcs	1	1	1
Weight kg/100 pcs.	26.300	26.300	26.300
<b>Item No.</b>	<b>2005458</b>	<b>2005528</b>	<b>2005598</b>

PC Polycarbonate

## Empty housing X 06

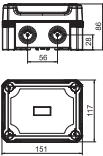

Type	X06C LGR	X06C LGR-TR	X06C SW
Colour	Light grey	Grey / transparent	Graphite black
Dimension LxWxH mm	151x167x87	151x167x87	151x167x87
Clear internal dimensions mm	137 x 105 x 68	137 x 105 x 68	137 x 105 x 68
Pack. pcs	1	1	1
Weight kg/100 pcs.	33.100	33.100	33.500
<b>Item No.</b>	<b>2005462</b>	<b>2005532</b>	<b>2005602</b>

PC Polycarbonate

## Empty housing X 10

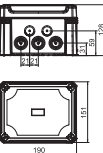

Type	X10C LGR	X10C LGR-TR	X10C SW
Colour	Light grey	Grey / transparent	Graphite black
Dimension LxWxH mm	191x151x126	191x151x126	191x151x126
Clear internal dimensions mm	177 x 137 x 110	177 x 137 x 110	177 x 137 x 110
Pack. pcs	1	1	1
Weight kg/100 pcs.	58.500	85.500	58.500
<b>Item No.</b>	<b>2005466</b>	<b>2005536</b>	<b>2005606</b>

PC Polycarbonate

## Empty housing X 16

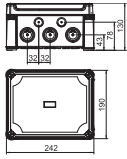

**Type**  
 Colour  
 Dimension LxWxH mm  
 Clear internal dimensions mm  
 Pack. pcs  
 Weight kg/100 pcs.  
**Item No.**

	<b>X16C LGR</b>	<b>X16C LGR-TR</b>	<b>X16C SW</b>
Colour	Light grey	Grey / transparent	Graphite black
Dimension LxWxH mm	241x191x126	241x191x126	241x191x126
Clear internal dimensions mm	227 x 177 x 110	227 x 177 x 110	227 x 177 x 110
Pack. pcs	1	1	1
Weight kg/100 pcs.	78.400	78.400	78.400
<b>Item No.</b>	<b>2005470</b>	<b>2005540</b>	<b>2005610</b>

**PC** Polycarbonate

## Empty housing X 25

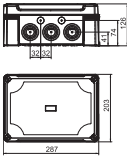

**Type**  
 Colour  
 Dimension LxWxH mm  
 Clear internal dimensions mm  
 Pack. pcs  
 Weight kg/100 pcs.  
**Item No.**

	<b>X25C LGR</b>	<b>X25C LGR-TR</b>	<b>X25C SW</b>
Colour	Light grey	Grey / transparent	Graphite black
Dimension LxWxH mm	286x202x126	286x202x126	286x202x126
Clear internal dimensions mm	271 x 187 x 110	271 x 187 x 110	271 x 187 x 110
Pack. pcs	1	1	1
Weight kg/100 pcs.	95.000	95.000	95.000
<b>Item No.</b>	<b>2005474</b>	<b>2005544</b>	<b>2005614</b>

**PC** Polycarbonate

## Empty housing, X series without entries with hat profile rail



- In comparison to junction boxes, empty housings do not have any entry openings. They can be drilled individually for the application
- Tested to DIN EN 60670 Part 1 and 22
- Besides screw cover caps and external fastening elements, the scope of delivery also contains a hat rail set consisting of a hat rail, type 2069, and matching fastening elements

### Empty housing X 06 with hat profile rail

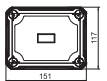
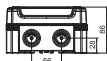

Type	X06C R LGR	X06C R LGR-TR
Colour	Light grey	Grey / transparent
Dimension LxWxH mm	151x167x87	151x167x87
Clear internal dimensions mm	137 x 105 x 68	137 x 105 x 68
Pack. pcs	1	1
Weight kg/100 pcs.	37.600	37.600
Item No.	2005490	2005560

PC Polycarbonate

With hat profile rail, type 2069, and fastening set.

### Empty housing X 10 with hat profile rail

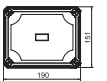
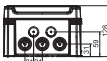

Type	X10C R LGR	X10C R LGR-TR
Colour	Light grey	Grey / transparent
Dimension LxWxH mm	191x151x126	191x151x126
Clear internal dimensions mm	177 x 137 x 110	177 x 137 x 110
Pack. pcs	1	1
Weight kg/100 pcs.	65.600	65.600
Item No.	2005494	2005564

PC Polycarbonate

With hat profile rail, type 2069, and fastening set.

## Empty housing X 16 with hat profile rail

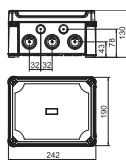

### Type

Colour  
Dimension LxWxH mm  
Clear internal dimensions mm  
Pack. pcs  
Weight kg/100 pcs.  
**Item No.**

X16C R LGR	X16C R LGR-TR
Light grey	Grey / transparent
241x191x126	241x191x126
227 x 177 x 110	227 x 177 x 110
1	1
87.300	87.300
<b>2005498</b>	<b>2005568</b>

PC Polycarbonate

With hat profile rail, type 2069, and fastening set.

## Empty housing X 25 with hat profile rail

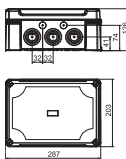

### Type

Colour  
Dimension LxWxH mm  
Clear internal dimensions mm  
Pack. pcs  
Weight kg/100 pcs.  
**Item No.**

X25C R LGR	X25C R LGR-TR
Light grey	Grey / transparent
286x202x126	286x202x126
271 x 187 x 110	271 x 187 x 110
1	1
107.000	107.000
<b>2005502</b>	<b>2005572</b>

PC Polycarbonate

With hat profile rail, type 2069, and fastening set.

## Pressure balance plug - 109

Type	Thread	Protection rating	Colour	Pack. pcs	Weight kg/100 pcs.	Item No.
<b>109 M20 LGR</b>	M20 x 1.5	IP68	Light grey	5	0.538	<b>2034680</b>

The pressure balance plug, type 109..., has the protection rating IP68/IP69 and therefore doesn't impede the protection class of the housing. The polyamide pressure balance plug is surrounded by an ePTFE membrane, which is permeable in both directions to air, but which does not let any moisture in.

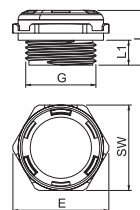

## EDS plug-in seal, light grey

Type	Size	For Ø mm	Colour	Pack. pcs	Weight kg/100 pcs.	Item No.
<b>EDS M20 LGR</b>	M20	0 - 17	Light grey	100	0.125	<b>2012350</b>
<b>EDS M25 LGR</b>	M25	0 - 22	Light grey	100	0.185	<b>2012354</b>
<b>EDS M32 LGR</b>	M32	0 - 28	Light grey	50	0.295	<b>2012358</b>

PE Polyethylene

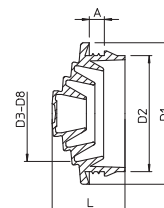

## Terminal strip 2.5 mm<sup>2</sup>



Type	Colour	No. of terminals	Nominal cross-section mm <sup>2</sup>	Nom. voltage V	Pack. pcs	Weight kg/100 pcs.	Item No.
<b>689</b>	Light grey	5	0.8 - 2.5	660	50	1.502	<b>2017342</b>

PA Polyamide

Terminal strip, nickel-plated brass, steel screws, galvanised and transparently passivated, nominal cross-section 0.8 - 2.5 mm<sup>2</sup>, nominal voltage 660 V, 5-pole, with terminal sockets, max. connectable cross-sections per terminal: 4 x 2.5 mm<sup>2</sup>, 5 x 1.5 mm<sup>2</sup> or 6 x 1 mm<sup>2</sup>, unnecessary poles can be cut off and used as individual terminals.

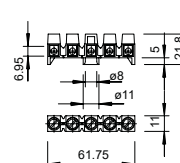

## Terminal strip 6 mm<sup>2</sup>



Type	Colour	No. of terminals	Nominal cross-section mm <sup>2</sup>	Nom. voltage V	Pack. pcs	Weight kg/100 pcs.	Item No.
<b>KL-T 02-06</b>	Light grey	5	1.5 - 6	400	10	4.380	<b>2016185</b>

PA Polyamide

Steel terminal block and bolts, galvanised and transparently passivated, nominal 1.5 - 6 mm<sup>2</sup>, nominal voltage 400 V, 5-pole, with terminal sockets, Max. connectable cross-sections per terminal: 3 x 6 mm<sup>2</sup>, 4 x 4 mm<sup>2</sup> or 6 x 2.5 mm<sup>2</sup>.

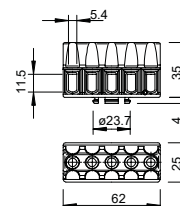

## Terminal strip 16 mm<sup>2</sup>



Type	Colour	No. of terminals	Nominal cross-section mm <sup>2</sup>	Nom. voltage V	Pack. pcs	Weight kg/100 pcs.	Item No.
<b>KL-T 06-16</b>	Light grey	4	6 - 16	400	10	1.970	<b>2016190</b>

PA Polyamide

Brass terminals, steel screws, electrogalvanised and transparently passivated, nominal cross-section 6 - 16 mm<sup>2</sup>, nominal voltage 400 V, 1-pole, with terminal sockets, Max. connectable conductors per terminal max. 4 x 16 mm<sup>2</sup>, 4 x 10 mm<sup>2</sup>, 8x6 mm<sup>2</sup> or 12 x 4 mm<sup>2</sup>.

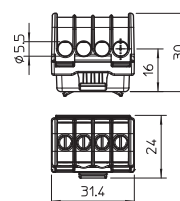

## Terminal strip 35 mm<sup>2</sup>

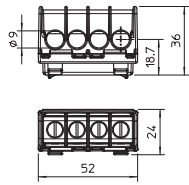

Type	Colour	No. of terminals	Nominal cross-section mm <sup>2</sup>	Nom. voltage V	Pack. pcs	Weight kg/100 pcs.	Item No.
<b>KL-T 16-35</b>	Light grey	4	16 - 35	400	10	5.630	<b>2016195</b>

PA Polyamide

Brass terminals, steel screws, electrogalvanised and transparently passivated, nominal cross-section 16 - 35 mm<sup>2</sup>, nominal voltage 400 V, 1-pole, with terminal sockets, Max. connectable conductors per terminal max. 4 x 35 mm<sup>2</sup>, 4 x 25 mm<sup>2</sup>, 8x16 mm<sup>2</sup> or 12 x 10 mm<sup>2</sup>.

## Terminal strip set for X series

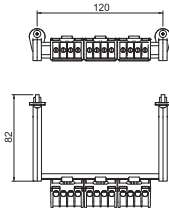

Type	Nominal cross-section mm <sup>2</sup>	Pole number	Number of screwless terminals per pole	Pack. pcs	Weight kg/100 pcs.	Item No.
<b>KL-X10 06-16</b>	6 - 16	5	4	1	17.600	<b>2008931</b>
<b>KL-X16 06-16</b>	6 - 16	5	4	1	14.500	<b>2008935</b>
<b>KL-X25 16-35</b>	6 - 16	5	4	1	37.500	<b>2008939</b>

## Main terminal block, 4-pole

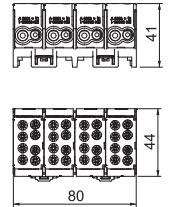

Type	Max. conductor cross-section mm <sup>2</sup>	Number of screwless terminals per pole	Pole number	Pack. pcs	Weight kg/100 pcs.	Item No.
<b>Hlak 4-8x16</b>	25	4	4	1	19.200	<b>2009032</b>

## Main terminal block, 5-pole

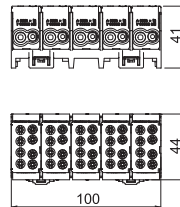

Type	Max. conductor cross-section mm <sup>2</sup>	Number of screwless terminals per pole	Pole number	Pack. pcs	Weight kg/100 pcs.	Item No.
<b>Hlak 5-10x16</b>	25	4	5	1	23.100	<b>2009036</b>

## Main terminal block, 5-pole

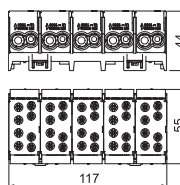

Type	Max. conductor cross-section mm <sup>2</sup>	Number of screwless terminals per pole	Pole number	Pack. pcs	Weight kg/100 pcs.	Item No.
<b>Hlak 5-10x25</b>	35	4	5	1	38.100	<b>2009038</b>

## Main terminal block, 1-pole

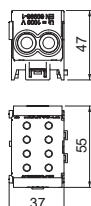

Type	Max. conductor cross-section mm <sup>2</sup>	Number of screwless terminals per pole	Pole number	Pack. pcs	Weight kg/100 pcs.	Item No.
<b>Hlak 1-2x35 GR</b>	70	4	1	1	11.600	<b>2009042</b>
<b>Hlak 1-2x35 GRGN</b>	70	4	1	1	11.600	<b>2009044</b>
<b>Hlak 1-2x35 GRBL</b>	70	4	1	1	11.600	<b>2009046</b>



## Hat rail set

Type	Length mm	Width mm	Height mm	Pack. pcs	Weight kg/100 pcs.	Item No.
<b>2069 X06 FS</b>	118	35	8	1	4.300	<b>1115876</b>
<b>2069 X10 FS</b>	161	62	23	1	7.400	<b>1115879</b>
<b>2069 X16 FS</b>	211	62	23	1	9.200	<b>1115882</b>
<b>2069 X25 FS</b>	252	62	23	1	10.700	<b>1115887</b>

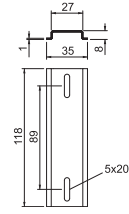

OBO Bettermann Holding GmbH & Co. KG  
P.O. Box 1120  
58694 Menden  
GERMANY

Customer Service  
Tel.: +49 (0)2373 89-1700  
Fax: +49 (0)2373 89-1238  
[export@obo.de](mailto:export@obo.de)

[www.obo-bettermann.com](http://www.obo-bettermann.com)

---

**Building Connections**

